

## Adjustable Pipe Saddle with U-Bolt Fig. 265 (Formerly Afcon Fig. 708)

**Size Range:** 4" through 36"

**Material:** Cast iron saddle, steel yoke and nuts, steel locknut nipple and special cast iron reducer. (14" through 36" carbon steel saddle with steel yoke. 4" through 12" steel saddle available upon special request).

**Finish:** Plain or Hot-Dip Galvanized Saddle, EG U-bolt and hardware, EG nipple and reducer assembly. Available with Hot-Dip U-bolt and hardware upon special request.

**Service:** Stanchion type support where vertical adjustment is required, plus the additional stability provided by U-bolt attachment to pipe.

**Approvals:** Complies with Federal Specification A-A-1192A (Type 38), WW-H-171-E (Type 39), ANSI/MSS SP-69 and MSS SP-58 (Type 38).

**Installation:** Adjustment is obtained by turning the locknut nipple. The lower end of the nipple is staked, upsetting the threads to prevent separation of nipple and coupling during adjustment.

**Features:**

- Vertical adjustment of approximately 4 1/2"
- Saddle supports a broad range of pipe sizes

**Ordering:** Specify pipe size to be supported, figure number, name and finish.

**Order Separately:** Figure 63T Square Cut Threaded End Stanchion. Specify "H" and pipe size to be supported by Figure 265.

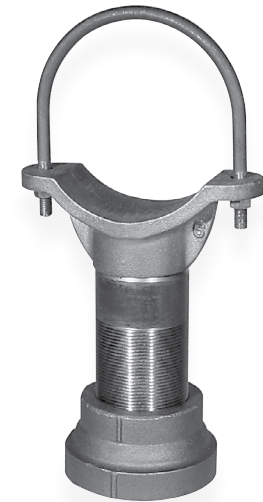

**Fig. 265: Dimensions (in) • Loads (lbs) • Weight (lbs)**

Pipe Size	Weight		A	B	D	E		Width C	Max Load
	Complete	Saddle Only				Min	Max		
4	22.0	10.8		4 <sup>3</sup> / <sub>16</sub>		9 <sup>1</sup> / <sub>2</sub>	14		
5	23.1	12.1		4 <sup>13</sup> / <sub>16</sub>		10 <sup>1</sup> / <sub>8</sub>	14 <sup>5</sup> / <sub>8</sub>		
6	23.9	12.7		5 <sup>7</sup> / <sub>16</sub>		10 <sup>3</sup> / <sub>4</sub>	15 <sup>1</sup> / <sub>4</sub>	3 <sup>5</sup> / <sub>8</sub>	3,800
8	32.5	21.3	4	6 <sup>15</sup> / <sub>16</sub>	3	12 <sup>1</sup> / <sub>4</sub>	16 <sup>3</sup> / <sub>4</sub>		
10	36.9	25.7		8 <sup>7</sup> / <sub>16</sub>		13 <sup>3</sup> / <sub>4</sub>	18 <sup>1</sup> / <sub>4</sub>		
12	42.4	31.2		9 <sup>15</sup> / <sub>16</sub>		14 <sup>5</sup> / <sub>8</sub>	19 <sup>1</sup> / <sub>8</sub>		
14	39.2	28.0		10 <sup>1</sup> / <sub>2</sub>		15 <sup>13</sup> / <sub>16</sub>	20 <sup>5</sup> / <sub>16</sub>		5,300
16	42.2	31.0		11 <sup>1</sup> / <sub>2</sub>		16 <sup>13</sup> / <sub>16</sub>	21 <sup>5</sup> / <sub>16</sub>		6,700
18	60.0	40.0		13 <sup>1</sup> / <sub>2</sub>		19 <sup>1</sup> / <sub>8</sub>	23 <sup>5</sup> / <sub>8</sub>		
20	63.0	43.0		14 <sup>1</sup> / <sub>2</sub>		20 <sup>1</sup> / <sub>8</sub>	24 <sup>5</sup> / <sub>8</sub>		
22	66.0	46.0		15 <sup>1</sup> / <sub>2</sub>		21 <sup>5</sup> / <sub>16</sub>	25 <sup>13</sup> / <sub>16</sub>	6	
24	72.0	52.0		17 <sup>1</sup> / <sub>2</sub>	4	23 <sup>5</sup> / <sub>16</sub>	27 <sup>13</sup> / <sub>16</sub>		
26	75.0	57.0	6	18 <sup>1</sup> / <sub>2</sub>		24 <sup>5</sup> / <sub>16</sub>	28 <sup>13</sup> / <sub>16</sub>		7,300
30	89.0	69.0		20 <sup>5</sup> / <sub>8</sub>	26 <sup>7</sup> / <sub>16</sub>	30 <sup>15</sup> / <sub>16</sub>			
32	93.0	73.0		21 <sup>5</sup> / <sub>8</sub>		27 <sup>7</sup> / <sub>16</sub>	31 <sup>5</sup> / <sub>16</sub>		
36	101.0	81.0		23 <sup>5</sup> / <sub>8</sub>		29 <sup>7</sup> / <sub>16</sub>	33 <sup>15</sup> / <sub>16</sub>		

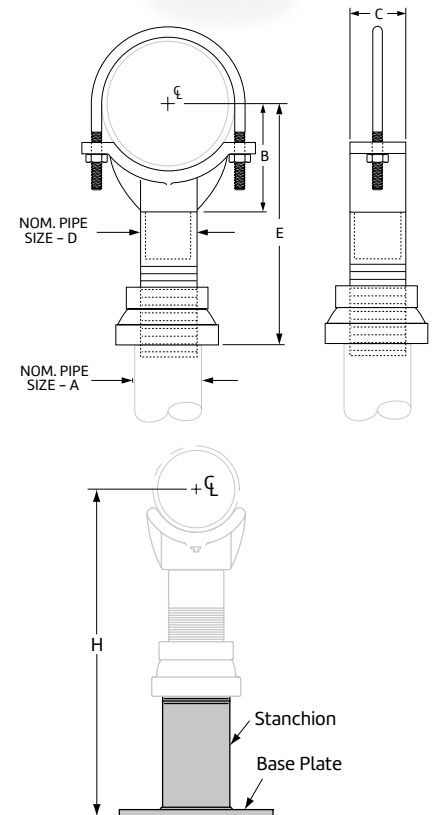

**Fig. 63, Type T**

Square Cut Threaded End for use with Figure 264 or 265 Adjustable Pipe Saddle Support

\*The special cast iron reducer may be furnished with a hexed shaped smaller end.

\*Standard Wall Pipe

The above load ratings are applicable to the saddle only and are not applicable to the stanchion or other means used to support the saddle.

PROJECT INFORMATION	APPROVAL STAMP
Project:	Approved
Address:	Approved as noted
Contractor:	Not approved
Engineer:	Remarks:
Submittal Date:	
Notes 1:	
Notes 2:	