

## SlideLOK® Ready for Installation Coupling Fig. 74FP



\*Patented

The patented SlideLOK coupling is the most rigid ready for installation coupling designed to reduce installation time. The slide action eases assembly and reduces installation time. The patented gasket provides four separate sealing surfaces for added protection.

The SlideLOK coupling is designed to be used with roll, cut or swage grooved steel pipe, Gruvlok and SPF® grooved-end fittings, and valves.

The SlideLOK coupling allows for a maximum working pressure of 450 psi on roll or cut grooved carbon steel standard wall pipe. The SlideLOK coupling provides a rigid connection allowing pipe hanging practices per ASME B31 Pipe Codes.

For Listings/Approval Details and Limitations, visit our website at [www.asc-es.com](http://www.asc-es.com) or contact an ASC Engineered Solutions™ Sales Representative.

\* Patents: 8282136; 8550502; 8615865; 9039046; 9168585; 9194516; 9297482; 9297484; 9500307; 9534715; 9631746; D680629; D680630; D696751

### Material Specifications

#### Housing

Ductile Iron conforming to ASTM A536, Grade 65-45-12

#### Bolts

SAE J429, Grade 5, Zinc Electroplated (standard)  
SAE J429, Grade 5, Thermo-Diffusion Coated (special order)

#### Heavy Hex Nuts

ASTM A563, Grade A, Zinc Electroplated, Violet Dyed (standard)  
ASTM A563, Grade A, Thermo-Diffusion Coated (special order)

#### Hardware Kits

304 Stainless Steel (available in sizes up to 3/4")  
Kit includes:  
(2) Bolts per ASTM A193, Grade B8  
(2) Heavy Hex Nuts per ASTM A194, Grade 8

#### Coatings

Rust inhibiting paint  
Color: Orange (Standard)  
Hot Dipped Zinc Galvanized (Optional)

#### Gasket Material

Properties as designated in accordance with ASTM D2000

**Pre-Lubricated Grade "E" EPDM**, Type A Gasket (Violet color code)

-40°F to 150°F (Service Temperature Range)  
(-40°C to 66°C)

Recommended for wet and dry (oil free air) pipe fire protection sprinkler systems. For dry pipe systems and freezer applications, Gruvlok Xtreme Lubricant is required.

#### Gasket Material

SlideLOK (1" - 8")

#### Lubrication

Gruvlok Xtreme



SlideLOK Pressure Responsive Gasket



**GRUVLOK**  
An ASC Engineered Solution

PROJECT INFORMATION	APPROVAL STAMP
Project:	Approved
Address:	Approved as noted
Contractor:	Not approved
Engineer:	Remarks:
Submittal Date:	
Notes 1:	
Notes 2:	

## SlideLOK® Ready for Installation Coupling Fig. 74FP

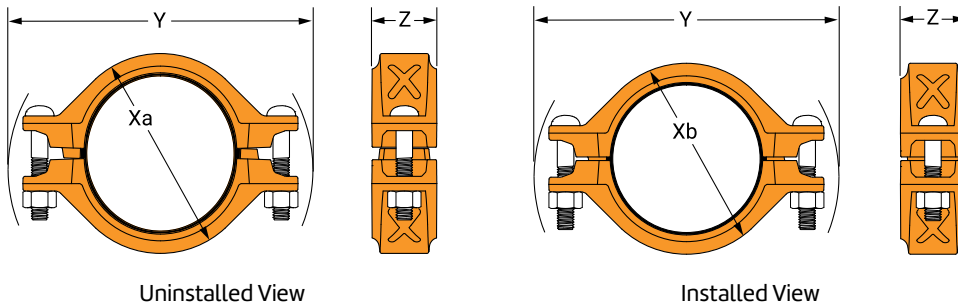

Figure Number	Nominal Size	Pipe O.D.	Max. Working Pressure ▲	Max. End Load	Range of Pipe End Separation	Coupling Dimensions				Coupling Bolts		Approx. Wt. Ea.
						Xa	Xb	Y	Z	Qty.	Size	
	In./DN(mm)	In./mm	PSI/bar	Lbs./kN	In./mm	In./mm	In./mm	In./mm	In./mm		In./mm	Lbs./kg
74FP	1 25	1.315 33.4	450 31.0	611 2.72	0-3/16 0-4.8	2 11/16 68	2 1/2 64	5 127	2 51	2	3/8 x 2 1/4 M10 x 57	1.5 0.7
74FP	1 1/4 32	1.660 42.2	450 31.0	973 4.33	0-3/16 0-4.8	2 29/32 74	2 1/2 64	5 17/32 140	2 51	2	1/2 x 2 3/4 M12 x 70	1.9 0.9
74FP	1 1/2 40	1.900 48.3	450 31.0	1,275 5.67	0-3/16 0-4.8	3 5/32 80	2 3/4 70	5 11/16 144	2 51	2	1/2 x 2 3/4 M12 x 70	2.1 1.0
74FP	2 50	2.375 60.3	450 31.0	1,993 8.87	0-3/16 0-4.8	4 13/32 112	4 102	6 15/32 164	2 51	2	1/2 x 2 3/4 M12 x 70	2.5 1.1
74FP	2 1/2 65	2.875 73.0	450 31.0	2,921 12.99	0-3/16 0-4.8	4 3/16 106	3 11/16 94	6 11/16 170	2 51	2	1/2 x 2 3/4 M12 x 70	2.6 1.2
74FP	3 80	3.500 88.9	450 31.0	4,329 19.26	0-3/16 0-4.8	4 29/32 125	4 13/32 112	7 3/8 187	2 51	2	1/2 x 3 M12 x 76	3.1 1.4
74FP	4 100	4.500 114.3	400 27.6	6,361 28.30	0-1/4 0-6.3	5 31/32 152	5 13/32 137	8 11/16 221	2 51	2	1/2 x 3 1/2 M12 x 89	3.1 1.4
74*	5 125	5.563 141.3	300 20.7	7,291 32.43	0-5/16 0-7.9	7 1/4 184	6 3/4 171	10 1/2 267	2 51	2	5/8 x 3 1/2 M16 x 89	5.5 2.5
74*	6 150	6.625 168.3	300 20.7	10,341 46.00	0-5/16 0-7.9	8 5/16 211	7 3/4 197	11 279	2 51	2	5/8 x 3 1/2 M16 x 89	6.3 2.9
74*	8 200	8.625 219.1	300 20.7	17,527 77.96	0-5/16 0-7.9	10 3/4 273	10 1/8 273	14 356	2 1/2 64	2	3/4 x 4 1/2 M20 x 115	14.3 6.5

**Note:**

Range of Pipe End Separation values are for system layout reference only. Actual installation spacing may vary based on pipe condition.

\*When ordering, refer to product as FP74.

▲ – Maximum Working Pressure Rating is for Schedule 40 pipe.

For use in Dry Pipe Systems: The SlideLOK pressure responsive gasket is featured with four sealing surfaces to increase protection in low temperature applications. Once the SlideLOK gasket is installed, the performance of the gasket is equivalent to the Gruvlok Flush Gap Gasket. Note: The Flush Gap Gasket is not interchangeable with the SlideLOK gasket.

**WARNING:** For dry pipe systems and freezer applications lubrication of the gasket is required, Gruvlok Xtreme Lubricant is required.



asc-es.com

Building connections that last™

## SlideLOK® Ready for Installation Coupling Fig. 74FP

### Listings and Approvals

Manufacturer	Pipe	Groove	NPS Size Range	Pressure Rating	
				cULus	FM
			In./DN(mm)	PSI/bar	PSI/bar
Schedule 40*		Roll, Cut	1-4	450	450
			25-100	31.0	31.0
			5-6	300	300
			125-150	20.7	20.7
Schedule 30*		Roll	8	400	400
			200	27.6	27.6
Schedule 10*		Roll	1-4	365	365
			25-100	25.2	25.2
			5-6	300	300
			125-150	20.7	20.7
0.188 in. Wall		Roll	8	NR	400
			200	—	27.6
Wheatland Tube	Schedule 10	Swage	1¼-4	365	300
			32 - 100	25.2	20.7
	Mega-Flow	Swage	1¼-4	NR	300
			32 - 100	—	20.7
	Mega-Thread	Roll	1¼-4, 6	300	300
			32-100, 150	20.7	20.7
	GL	Roll	1-2	300	300
			25-50	20.7	20.7
	MLT	Roll	1-2	300	300
			25-50	20.7	20.7
WLS	Roll	1-2	300	NR	
		25-50	20.7	—	
Youngstown	Fire-Flow	Roll	1½- 4	300	300
			40-100	20.7	20.7
Bull Moose Tube	EZ-Thread	Roll	1-2	300	300
			25-50	20.7	20.7
Eddy-Flow	Roll	1¼-4	300	300	
			32-100	20.7	20.7
Eddy-Thread 40	Roll	1-2	300	300	
			25-50	20.7	20.7

**Note:**

For the latest cULus pressure ratings, FM pressure ratings, and pipe approvals, please visit [asc-es.com](http://asc-es.com) or contact your local ASC Engineered Solutions Representative.

\* Schedule 40/30 pipe to ASTM A795/A53/ASME B36.10 in accordance with NFPA-13.

\* Schedule 10 pipe to ASTM A135/A795/A53 in accordance with NFPA-13.



[asc-es.com](http://asc-es.com)

Building connections that last™

## Fig. 74FP SlideLOK® Ready for Installation Coupling



Read and understand all instructions before use.

### WARNING

Ensure system is drained and depressurized before installation or service.

Use appropriate personal protective equipment.



Failure to follow these instructions could result in serious personal injury and/or property damage.

### 1 Pipe Preparation

Pipe ends are to be cut, rolled or swage grooved according to ASC Engineered Solutions™ specifications. Not for use on "EG" grooved pipe ends. The pipe end must be smooth and free from metal burrs, sharp edges or projections.

### 2 Gasket Preparation

Ensure the gasket is suitable for the intended application by referring to the ASC gasket compatibility chart.

SlideLOK pre-lubricated gasket does not require lubrication.

**Notice:** Gruvlok Xtreme Lubricant must be applied when used in dry pipe systems or freezer applications.

### 3 Assembly

The SlideLOK Fig. 74FP may be installed by one of two methods. The preferred method depends on the type of pipe components being joined and their orientation. Please review both methods before installing.

#### Step 3 – Method No. 1

Slide the SlideLOK coupling completely over the grooved pipe end. This will allow a clear and un-obstructed view of the pipe for correct alignment.

**A.** Slide the coupling on the pipe past the groove. The bolts and nuts can be hand tightened to position the coupling in place.

**B.** Align the mating pipe end. Align the two adjoining pipes together.

**C.** Slide the coupling back over the grooves so that the coupling keys are located over the respective grooves on both pipe ends.

**D.** Follow the instructions on fastening the coupling as shown in Step 4.



#### Step 3 – Method No. 2

Slide the SlideLOK coupling half way onto the pipe end or fitting. This will better accommodate fitting, and valve accessories during installation.

**A.** Slide the coupling on the fitting so that the groove and keys are aligned.

**B.** Bring the pipe end or fitting towards the

coupling and insert so that the groove and coupling keys are aligned.

**C.** Hand tighten the nuts to correctly position the couplings keys over the respective grooved ends.

**D.** Follow the instructions on fastening the coupling as shown in Step 4.

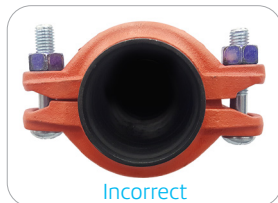

### READY FOR INSTALLATION – RIGHT OUT OF THE BOX

Do not disassemble the SlideLOK Coupling. The 74FP coupling is ready for installation. The bolt and gasket do not need to be removed.

### 4 Tighten Nuts

Securely tighten nuts alternately and equally, keeping the gaps at the bolt pads evenly spaced.

**Notice:** Uneven tightening may cause the gasket to pinch. Gasket should not be visible between segments after bolts are tightened.

#### ANSI Specified Bolt Torque

Bolt Size	Wrench Size	Specified Bolt Torque*
In.	In.	Ft.-Lbs
3/8	11/16	40-50
1/2	7/8	80-100
5/8	1 1/16	100-130
3/4	1 1/4	130-180

\* Non-lubricated bolt torque



### 5 Assembly is complete

Visually inspect the pipe joint to assure the coupling keys are fully engaged in the pipe grooves. The bolt pads are to have equal gaps on each side of the coupling.

**Notice:** Visually inspect both sides of the coupling to ensure gaps between bolt pads are evenly spaced and are parallel. Any deviations must be corrected before placing coupling into service.

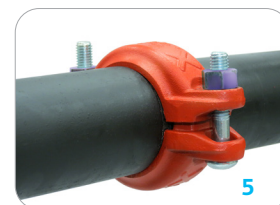

asc-es.com

Building connections that last™

## Fig. 74FP SlideLOK® Ready for Installation Coupling



Read and understand all instructions before use.

### WARNING

Ensure system is drained and depressurized before installation or service.

Use appropriate personal protective equipment.



Failure to follow these instructions could result in serious personal injury and/or property damage.

### 1 De-Pressurize the System

De-pressurize the system before removing the SlideLOK Coupling. Dis-assemble the couplings by removing the nuts, bolts and gasket from the housing halves. A wrench is required to overcome the epoxy used to secure the nuts on the bolts.

### 2 Pipe Preparation

Pipe ends are to be cut, rolled or swage grooved according to ASC Engineered Solutions™ specifications. Not for use on "EG" grooved pipe ends. The pipe end must be smooth and free from metal burrs or projections.

### 3 Gasket Preparation

Ensure the gasket is suitable for the intended application by referring to the ASC gasket compatibility chart. A light coating of Gruvlok XTreme lubricant must be applied to the gasket prior to installation.



### 4 Pipe Alignment and Gasket Installation

Slide the gasket onto the pipe then align the two pipe ends together. Pull the gasket into position, centering it between the grooves on each pipe. Gasket should not extend into the groove on either pipe.

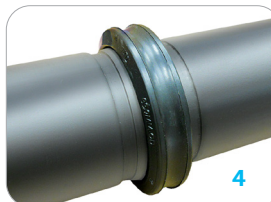

### 5 Housing Assembly

Place each of the housing halves on the pipe making sure the housing key fits into the groove. Be sure that the tongue and recess portions of the housing mate properly. Insert the bolts.

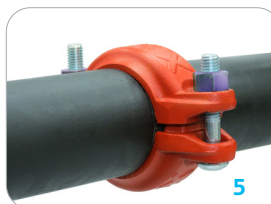

### 6 Tighten Nuts

Securely tighten nuts alternately and equally, keeping the gaps at the bolt pads evenly spaced.

**Notice:** Uneven tightening may cause the gasket to pinch. Gasket should not be visible between segments after bolts are tightened.

#### ANSI Specified Bolt Torque

Bolt Size	Wrench Size	Specified Bolt Torque*
In.	In.	Ft.-Lbs
3/8	11/16	40-50
1/2	7/8	80-100
5/8	1 1/16	100-130
3/4	1 1/4	130-180

\* Non-lubricated bolt torque



### REINSTALLATION OF THE 74FP SLIDELOK COUPLING

The SlideLOK coupling is designed to be installed in the ready for installation assembly position once. After the initial assemble the following steps are to be taken to re-install the 74FP SlideLOK coupling.

### 7 Assembly is complete

Visually inspect the pipe joint to assure the coupling keys are fully engaged in the pipe grooves. The bolt pads are to have equal gaps on each side of the coupling.

**Notice:** Visually inspect both sides of the coupling to ensure gaps between bolt pads are evenly spaced and are parallel. Any deviations must be corrected before placing coupling into service.



Correct

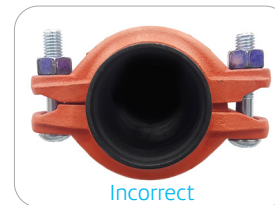

Incorrect



asc-es.com

Building connections that last™

## SlideLOK® Ready for Installation Coupling Fig. 74FP

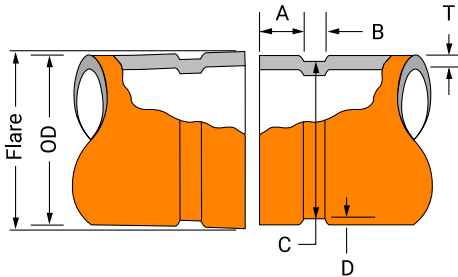

### Swage Groove Specification

-1-	-2-		-3-	-4-	-5-	-6-	-7-	-8-	
Nominal Pipe Size	O.D.		"A"	"B"	"C"	"C" Tol.	"D"	"T" Min. Allow.	Max. Flare
	Actual	Tolerance	$\pm 0.030 / \pm 0.76$	$\pm 0.030 / \pm 0.76$	Actual	+0.000	(Ref. Only)	Wall Thick	Diameter
In./DN(mm)	In./mm	+In./mm -In./mm	In./mm	In./mm	In./mm	-In./mm	In./mm	In./mm	In./mm
1¼ 32	1.660 42.2	+0.016 -0.016 +0.41 -0.41	0.625 15.88	0.281 7.14	1.535 38.99	-0.015 -0.38	0.063 1.60	0.065 1.7	1.770 45.0
1½ 40	1.900 48.3	+0.019 -0.019 +0.48 -0.48	0.625 15.88	0.281 7.14	1.775 45.09	-0.015 -0.38	0.063 1.60	0.065 1.7	2.010 51.1
2 50	2.375 60.3	+0.024 -0.024 +0.61 -0.61	0.625 15.88	0.344 8.74	2.250 57.15	-0.015 -0.38	0.063 1.60	0.065 1.7	2.480 63.0
2½ 65	2.875 73.0	+0.029 -0.029 +0.74 -0.74	0.625 15.88	0.344 8.74	2.720 69.09	-0.018 -0.46	0.078 1.98	0.083 2.1	2.980 75.7
3 80	3.500 88.9	+0.035 -0.031 +0.89 -0.79	0.625 15.88	0.344 8.74	3.344 84.94	-0.018 -0.46	0.078 1.98	0.083 2.1	3.600 91.4
4 100	4.500 114.3	+0.045 -0.031 +1.14 -0.79	0.625 15.88	0.344 8.74	4.334 110.08	-0.020 -0.51	0.083 2.11	0.083 2.1	4.600 116.8

#### Note:

**COLUMN 1** – Nominal IPS Pipe size.

**COLUMN 2** – IPS outside diameter.

**COLUMN 3** – Gasket seat must be free from scores, seams, chips, rust or scale which may interfere with proper sealing of the gasket. Gasket seat width (Dimension A) is to be measured from the pipe end to the vertical flank in the groove wall.

**COLUMN 4** – Groove width (Dimension B) is to be measured between vertical flank of the groove size walls.

**COLUMN 5** – The groove must be of uniform depth around the entire pipe circumference. (See column 6).

**COLUMN 6** – Groove depth: for reference only. Groove must conform to the groove diameter "C" listed in column 5.

**COLUMN 7** – Minimum allowable wall thickness which may be roll grooved.

**COLUMN 8** – Maximum allowable pipe end flare diameter. Measured at the most extreme pipe end diameter of the gasket seat area.

**Out of roundness:** Difference between maximum O.D. and minimum O.D. measured at 90° must not exceed total O.D. tolerance listed (reference column 2).

**For IPS pipe,** the maximum allowable tolerance from square cut ends is 0.03" for 1" thru 3½"; and 0.045" for 4".

**Weld Seams** must be ground flush with the pipe O.D. and ID prior to roll grooving. Failure to do so may result in damage to the roll grooving machine and unacceptable roll grooves may be produced.

▼ "A" tolerance +0.030" / -0.060" (+0.77 / -1.54 mm)



asc-es.com

Building connections that last™