

Building connections that last™

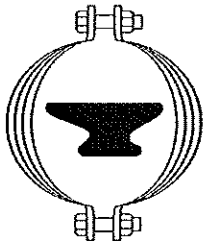

Installation Instructions for Anvil EPS Constant Support Hangers Fig. 81-H, Type F Upthrust





ANVIL EPS
ENGINEERED PIPE SUPPORTS

No. PE-217-81F
Page 2 of 7
Rev. 2
Date 3-1-10

TITLE:

**INSTALLATION INSTRUCTIONS FOR
ANVIL CONSTANT SUPPORT HANGERS, FIG.81-H,TYPE F UPTHURST**

TABLE OF CONTENTS

<u>Section</u>	<u>Title</u>	<u>Page</u>
	Title Page	1
	Table of Contents	2
1.0	General Instructions	3
2.0	Installation	3-5
3.0	Instructions for Load Adjustments	5-6
4.0	Inspection and Maintenance	6
	Appendix - Constant Support Catalog Information	7

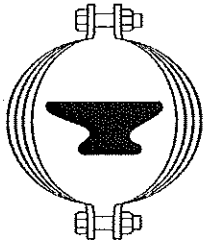

ANVIL EPS
ENGINEERED PIPE SUPPORTS

No. PE-217-81F
Page 3 of 7
Rev. 2
Date 3-1-10

TITLE:

**INSTALLATION INSTRUCTIONS FOR
ANVIL CONSTANT SUPPORT HANGERS, FIG.81-H,TYPE F UPTHURST**

1.0 GENERAL INSTRUCTIONS

The Upthrust Constant Support provides a constant supporting force throughout its entire travel range. That is, the supporting force does not vary with pipe deflection.....but remains constant.

Dimensions and data may be found in the Appendix.

- 1.2 Each Upthrust Constant Support is furnished with a position scale. There are two markers placed on the position scale at the factory - a white marker corresponding to the cold position and a red marker corresponding to the hot position.

2.0 INSTALLATION

- 2.1 The Upthrust Constant Support is mounted below the load on a firm structural base. The load is supported on the load saddle bearing plate without mechanical connection. The user must provide the method of applying the load to the bearing plate, making provision through the use of teflon rolls, balls, or other low friction means to accommodate any expected lateral motion.
- 2.2 Upthrust Supports are shipped with the load saddle in a locked position by means of locking nuts (Figure 1) on the travel stop rods. They are normally installed at the factory to hold the support in the "cold" position to facilitate installation. These rods will withstand the additional load of hydrostatic testing.
- a. Refer to the hanger assembly drawing for piping and structural attachment locations, general arrangements, etc.

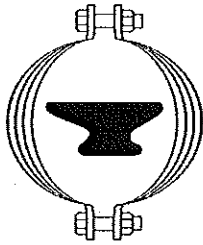

TITLE:

**INSTALLATION INSTRUCTIONS FOR
ANVIL CONSTANT SUPPORT HANGERS, FIG.81-H,TYPE F UPTHURST**

- b. Attach the Upthrust to the structural base. The anchor bolts must have sufficient thread length to accommodate grouting or shimming.

CAUTION

Anchor bolts must not interfere with travel of the load saddle.

- c. Connect the pipe attachment to the pipe and install on the load saddle bearing plate.
- d. The pipe attachment cannot be inclined more than 5° from vertical.
- e. As the supports were provided with the load saddles locked at the cold position, no further adjustments should be necessary.

If, however, any of the supports are not at the proper setting, it will be necessary to either add or remove shims or grout - or adjust the pipe attachment until the load saddle aligns with the cold position marker. This procedure does not change the supporting force of the support, but assures the support's capability of following the actual piping expansion and contraction.

After performing the preceding step, any units which indicate an overload or underload condition, proceed to Section 3 - Instructions for Load Adjustments.

- f. After all piping is installed and after hydrostatic testing at ambient temperatures, the load saddle must be unlocked before system operation. (See *NOTE* below.)
- 1) Slowly loosen the 8 locking nuts.

CAUTION

The load saddle may be under load due to field elevation tolerances or load calculation errors.

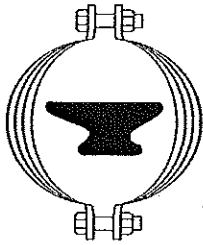

TITLE:

**INSTALLATION INSTRUCTIONS FOR
ANVIL CONSTANT SUPPORT HANGERS, FIG.81-H,TYPE F UPTHURST**

- 2) Run nuts up or down to the jam nuts which are tack welded to the travel stop rods where they will remain during normal operation.

NOTE:

Load saddle must be unlocked prior to any testing or cleaning of the system done above ambient temperatures, and if this causes greater loads than the design loads, temporary supports must be provided.

3.0 INSTRUCTIONS FOR LOAD ADJUSTMENTS

- 3.1 If a change is desired in the supporting force of the hanger, adjustment of up to +/-10% of the calibrated load can be made in the field.

The percentage increase or decrease from the factory adjusted load should be carefully calibrated from the arrow die-stamped on the load adjustment scale.

All adjustments should be made from this reference point, with each division on the scale equal to 2% of the calibrated load.

The load adjustment is made by turning the load adjustment bolt.

- 3.2 If, during or after installation of the constant supports the pipe cannot be held at the proper elevation with the position or travel indicator at the desired setting on the position or travel scale, proceed as follows:

- a. If the actual pipe load is greater than the supporting force of the constant supports,
correct by: increasing the supporting force of the hanger by 2% by means of the load adjustment bolt. If the load adjustment is insufficient to achieve the desired results, repeat the above in steps of 2% until the pipe can be held at the proper elevation with the travel indicator at the desired setting. Do not exceed a total of 10% adjustment without consulting your Anvil representative.

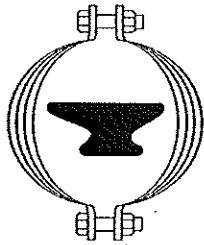

TITLE:

**INSTALLATION INSTRUCTIONS FOR
ANVIL CONSTANT SUPPORT HANGERS, FIG.81-H,TYPE F UPTHURST**

- b. If the actual pipe load is less than the supporting force of the constant supports,

correct by: decreasing the supporting force of the hanger by 2% by means of the load adjustment bolt. If the load adjustment is insufficient to achieve the desired results, repeat the above in steps of 2% until the pipe can be held at the proper elevation with the travel indicator at the desired setting. Do not exceed a total of 10% adjustment without consulting your Anvil representative.

If the desired results cannot be obtained with the available load adjustment, the weight of materials used in the hanger load calculations should be checked, new weight balance calculations performed, and new supports of a different size selected.

4.0 INSPECTION AND MAINTENANCE

- 4.1 Each support should be inspected annually to verify its travel position relative to pipe condition, hot or cold.
- 4.2 No lubrication of moving parts is required.
- 4.3 All dust, soot, and foreign objects which may impair support operation shall be removed.

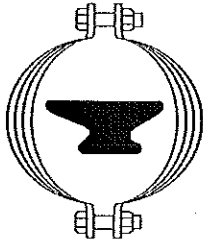

TITLE: **INSTALLATION INSTRUCTIONS FOR ANVIL CONSTANT SUPPORT HANGERS, FIG.81-H,TYPE F UPTHURST**

Appendix

fig. 81-H type F upthrust

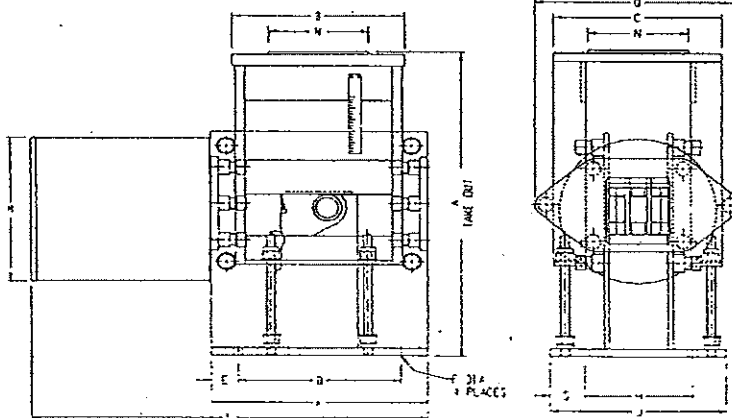
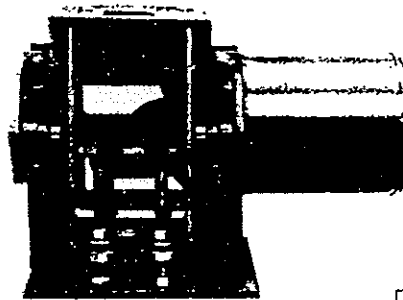

T.T.	TAKE-OUT FACTOR* "A"			
	SIZES			
	10-18	19-34	35-49	50-63
2	16.12	23.12	-	-
2.5	16.12	23.12	25.75	-
3	16.12	23.12	25.75	29.00
3.5	16.12	23.12	25.75	29.00
4	19.94	23.12	25.75	29.00
4.5	19.94	23.12	25.75	29.00
5	19.94	23.12	25.75	29.00
5.5	19.94	27.50	25.75	29.00
6	19.94	27.50	25.75	29.00
6.5	-	27.50	31.62	29.00
7	-	27.50	31.62	34.00
7.5	-	27.50	31.62	34.00
8	-	27.50	31.62	34.00
8.5	-	-	31.62	34.00
9	-	-	31.62	34.00
9.5	-	-	31.62	34.00
10	-	-	31.62	34.00

*For Down Travel Take-Out = "A" - (1/2) Actual Travel
For Up Travel Take-Out = "A" - (1/2) Actual Travel

The Upthrust is for support of piping or equipment from below. It has a base flange for fastening to the floor or beams. The load is supported during hydrostatic testing by means of (4) positioning studs. After testing the nuts are moved to either end of the stud to prevent interference during operation.

The Upthrust Constant Support is available for loads up to 24463 lbs.

Corrosion resistant units are available either galvanized or carbon-zinc painted.

dimensions (inches)

SIZE	TOTAL TRAVEL	A	B	C	D	E	F	G	H	J	K	L	M	N	P	Q
10-18	2-6	TAKE OUT	10 3/4	11 1/4	9	2 1/2	3/4	2	8	12	14	22 1/4	8 3/4	5	1/2	14 3/4
19-34	2-8		13 3/4	13 3/4	13	2 1/4	3/4	2	10	14	17 1/4	31 1/4	12 1/2	8	3/4	16 3/4
35-49	2 1/2-10		17 1/4	16 1/4	17	2	3/4	2	13	17	21	38 1/4	13 3/4	8	3/4	19 3/4
50-63	3-10		21 1/4	19 1/4	16 1/2	1 3/4	3/4	3 3/4	11 3/4	19	22 3/4	52	17 3/4	10	3/4	23 1/4

About ASC Engineered Solutions

ASC Engineered Solutions is defined by quality—in its products, services and support. With more than 1,400 employees, the company’s portfolio of precision-engineered piping support, valves and connections provides products to more than 4,000 customers across industries, such as mechanical, industrial, fire protection, oil and gas, and commercial and residential construction. Its portfolio of leading brands includes ABZ Valve®, AFCON®, Anvil®, Anvil EPS, Anvil Services, Basic-PSA, Beck®, Catawissa, Cooplet®, FlexHead®, FPPI®, Gruvlok®, J.B. Smith, Merit®, North Alabama Pipe, Quadrant®, SCI®, Sharpe®, SlideLOK®, SPF® and SprinkFLEX®. With headquarters in Commerce, CA, and Exeter, NH, ASC also has ISO 9001:2015 certified production facilities in PA, TN, IL, TX, AL, LA, KS, and RI.



asc-es.com

Building connections that last™

