

Installation, Operation, and Maintenance Manual

SHARPE[®] 4X4

4 Piston Pneumatic Actuator



MODEL: X40, X50, X60, X75, X90, and X115

WARNING AND SAFETY INSTRUCTIONS:

1. Read this Installation, Operation & Maintenance manual before using the actuator.
2. Sharpe[®] Valves cannot anticipate all of the situations a user may encounter while installing and using the 4x4 - 4 Piston Pneumatic Actuator. The user must know and follow all applicable industry specifications on the safe installation and use of these actuators. Only qualified personnel or technicians who are trained for maintenance work and have read the instructions are to assemble and disassemble the actuator. Misapplication of the product may result in injuries or property damage.
3. Before operating an actuator that is connected to a valve in the pipeline, make sure you know the valve function.
4. Make sure the actuator is not connected to the air supply or electrical system before attempting to do any maintenance.
5. Before removing the actuator from the valve, always make sure the line has been depressurized and drained. Cycle the valve a few times to relieve any pressure that could be trapped in the body cavity.
6. Use only **SHARPE[®]** components and spare parts supplied in the repair kits.
7. Do not use air pressure to remove the actuator pistons when the covers have been removed.
8. Do not leave any grip key or shaft connection attached to the actuator, or try to manually operate the actuator while it is still connected to the air supply.
9. The user must follow and observe any national or local safety laws imposed for their system.

STORAGE

The Sharpe[®] 4X4 - 4 Piston Actuator has been packaged to provide protection during shipment and storage. It is however possible that the actuator can be damaged during transport. Inspect the actuator for shipping damage prior to storage. Keep the actuators in their original boxes and store indoors in a clean dry environment until ready for use. Keep the plastic plugs in the air ports to prevent liquids or other materials from entering the actuator during storage. It is recommended to stroke them periodically to prevent setting of the seals.

OPERATING CONDITIONS:

LUBRICATION

The actuators are pre lubricated from the factory and under normal operating conditions do not require re-lubrication. In the event of actuator maintenance it is recommended to use the following lubricants:

- For NBR O-rings use EP1. The lubricant is suitable for use from -4°F to +180°F (-20°C to +82°C) with AIT/Flashpoint > (T-class +50K)
- For EPDM O-rings use only Silicone grease

SUPPLY PRESSURE

The supply pressures for the 4x4 actuators are as follows:

- **Double-acting:** 40-120 psig (2.75 - 8 barg)
- **Spring-return:** 40-120 psig (2.75 - 8 barg)

When sizing an actuator to available air supply, make sure you have adequate power in the actuator to allow the valve to complete its operation and leave enough power for a safety factor.

AIR SUPPLY

Use clean dry air. Other inert gases may be used such as nitrogen and argon.

Do not use water as a supply media. Do not use oxidizing, corrosive, flammable, explosive or unstable gases.

Oxygen or hydrogen must NEVER be used.

The operating medium is to be filtered to 30 micron particle size or less. Always consult with a representative of Sharpe® for suitability and recommended practice. Piping connected to the actuator or accessories should be fitted according to the recommended instrumentation piping practice. Prior to connection make sure all the lines have no loops and are free of water, oil or other contaminants that may be trapped in the pipes. Pipes must be flushed with air to clean the passages. Where sealants are being used for the threaded connections, care must be taken to avoid any excess material getting forced into the actuator ports.

TEMPERATURE

The standard temperature limits for the 4x4 actuators are -4°F (-20°C) to 180°F (82°C). For temperatures below or above these figures special preparation and materials are required such as grease, O-rings, pinion bearing and pads. The working temperature range is -40°F (-40°C) to 300°F (148°C) when used with EPDM O-rings and appropriate grease. For temperatures below -40°F (-40°C) please consult with a representative. When used in sub-zero temperatures it is essential to use an air dryer for the supply air to avoid any moisture. Always consult with a representative for the 4x4 suitability and recommended practice.

PRINCIPLE OF OPERATION

The 4x4 actuator is a pneumatic quarter-turn rack & pinion actuator. Air pressure applied to the piston surface area generates thrust which transforms linear motion to rotary motion of the pinion (Fig 1). The 4x4 has four pistons centrally located around one pinion. This means that the actuator can generate twice the torque of a dual piston actuator, is lightweight, occupies minimum space, and has minimal air consumption.

Fig. 1

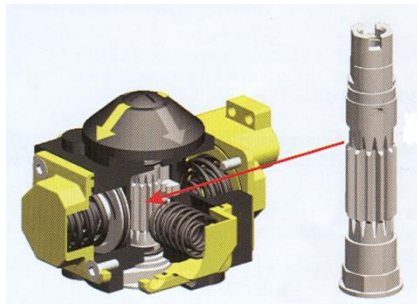

AIR CONNECTIONS

The actuator air connections are marked **A** and **B**.

The ports connect to a path of holes to all the four pistons. The air passes into the Namur cover (or insert) and through holes which are connected to the neighboring pistons. Each piston receives the air flow from two directions which ensures a quick response.

Looking from the top of the actuator:

- **A port** is on the left ; **B port** is on the right for X40 – X75
- **A port** is on the right ; **B port** is on the left for X90
- **A port** is on the top ; **B port** is on the bottom for X115

Double Acting (DA)

Fig. 2: Pressure entering port **A** to open. Pressure applied to the center chambers push the pistons outward and rotates the pinion **CCW** (counter clockwise).

Fig. 3: Pressure entering port **B** to close. The outer chamber pushes the pistons inward and rotates the pinion **CW** (clockwise).

Fig. 2

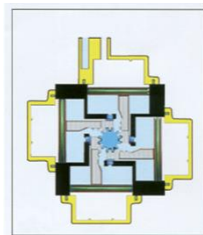
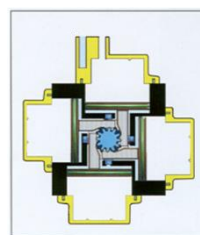

Fig. 3



Spring Return (SR)

Fig. 4: Pressure entering port **A** to open. Pressure applied to the center chambers push the pistons outward and rotates the pinion **CCW** (counter clockwise).

Fig. 5: Air released from center chamber. Springs push the pistons inward, Pinion rotates **CW** (clockwise).

Fig. 4

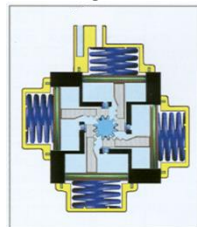
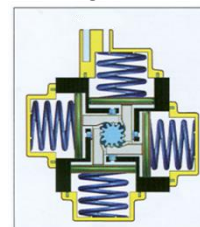

Fig. 5



NAMUR Solenoid Mounting

Air supply connection is done by mounting a solenoid directly onto the Namur cover which has a mounting pad conforming to the Namur standards (only solenoids made to the NAMUR standard can be mounted in this way.) The 4x4 actuator can also be piped with solid or flexible tubing from remote solenoid valves.

Mounting

The actuator bottom mounting is in accordance with ISO 5211 international standard and incorporates a star shaped female drive for flexibility to fit various valve output shafts. The valve can be attached by bracket or mounted directly onto the actuator, using one of the various ISO hole patterns depending on the design.

Travel Adjustment

The actuators are supplied factory adjusted to produce 90° rotation. The rotation is restricted by the stroke adjustment stop and four adjustment screws which provide fine tuning. The screws are threaded into the actuator body and are diametrically opposed to create simultaneous and equal forces on opposite sides of the stop to eliminate off-center forces. The standard stop screws allow for adjustment of $\pm 5^\circ$ in the travel limits going beyond the $\pm 5^\circ$ can result in damage to the actuator.

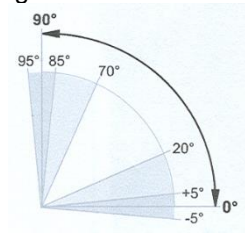

Indicator

All actuators are assembled with a highly visible indicator. The indicator has interchangeable “snap-on” flow direction arrows for identification of valve position. The arrows provide various patterns according to the valve ports.



TWO WAY



THREE WAY



L - PORT

Use a screw driver at the arrow head to gently push it out.



The indicator snaps to the pinion with its Namur interface projecting above it and enabling for ancillary items to connect to the pinion.

Identification

The 4x4 actuators are supplied with a nameplate which is located on the side of the body. The information includes actuator model, double acting or spring return, spring code, serial number and maximum air pressure.

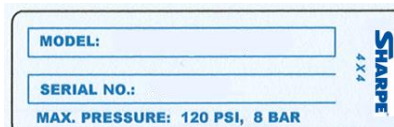

1. Disassembly

1.1 General

- Before performing any disassembly operations make sure you read all the warnings and safety instructions in this document.
- Do not attempt to disassemble the actuator while it is still connected to the valve or to any ancillary equipment.
- Verify that the actuator is not pressurized. Check that the air ports are vented and spring return actuators are in the fail position.
- Work in a clean area, free of dust, debris, grease, corrosives, and moisture. For security and comfort perform the repairs on a table with a vise and available air supply. Clamp a coupler in the vise and place the actuator drive on it. Note: A safe fixture with a better grip on the vise may be used instead of coupler.

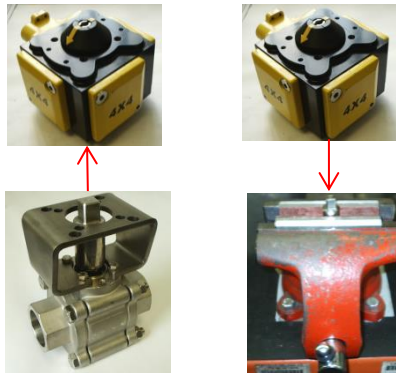

2. Disassembly of Covers

2.1 Before disassembly, mark the covers with the body to identify each cover to its original position as shown below. For disassembly of spring return covers, please follow section 3.



2.1 Remove the cover screws. If in the initial rotation the screws are jammed, tap them lightly on the head with a flat pin to loosen them. There are two (2) screws for each cover for models X40, X60, X75 and four (4) screws for the X90, and X115.



2.2 Remove the covers making sure not to damage the O-ring seals.



3. Disassembly of Spring Return Covers:
Caution: Springs in the actuator are pre-loaded.

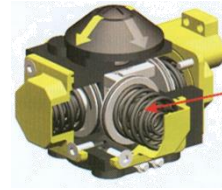

- 3.1 Before disassembly, mark each of the covers with the body refers to section 2.1.
- 3.2 Remove the cover screws in sequence by turning each opposing screw two rotations at a time. When removing the Namur cover make sure the O-ring connecting to the inner chamber is secure in its groove. If in the initial rotation the screws are jammed tap them lightly on the head with a flat pin to loosen them. When there are 4 screws in the cover, work on the two smaller screws first then loosen the larger screws slowly to release springs.
- 3.3 Remove the covers making sure not to damage the cover seals.
- 3.4 Remove the springs from the cylinder and lay them together in their covers for the assembly stage.
- 3.5 Follow the same routine on all four cylinders. **To replace the spring configuration or to convert to DA actuator, go to Section 6 for assembly.**

4. Piston Disassembly

- 4.1 Looking at the actuator as shown in Fig. 6 unscrew the left side of each pair of the stroke adjustment screws approximately 12 mm outward. This will enable the stop to rotate beyond its 90° limit so the pistons can come out. It may require a little force to release the adjustment screws as they are assembled with a thin layer of thread locker.

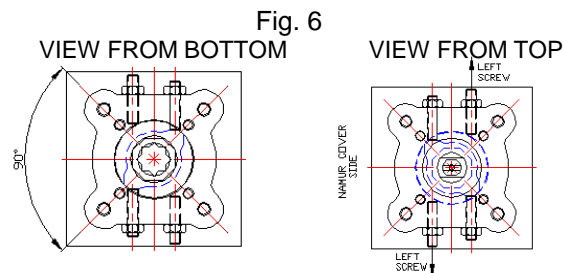

- 4.2 Grip the actuator body with both hands with the bottom hole engaged with the coupler in the vice to prevent the pinion from rotating. Rotate the body in clockwise direction to eject the 4 pistons out of their cylinders as demonstrated in Fig. 7.



- 4.3 Remove the piston O-rings (3) by pressing them slightly from both sides creating a loop and then pull them out of their groove. Do not use a sharp object to pry them out.



5 Pinion Disassembly

- 5.1 Unscrew the indicator screw (22), Remove the indicator (21). Use a screw driver to help remove it from the pinion. Do not apply excessive force to the indicator.
- 5.2 Remove the snap ring (19).
- 5.3 Push the pinion (13) down and remove it from the body.
- 5.4 The stroke adjustment stop (14), thrust washer (15) and pinion O-ring (16) will drop out with the pinion. There is no need to separate the stroke adjustment stop from the pinion. Make sure the stroke adjustment stop and pinion stay together in the same orientation they came out.
- 5.5 Remove the disc bearing (18), thrust washer (15) and O-ring (16) from the body.

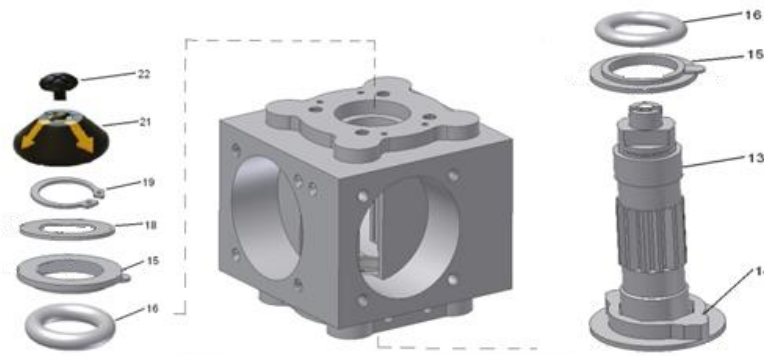

6 Assembly

General

Before performing assembly, clean the grease off of all the cylinders and actuator parts. Check the cylinders for any scratches. The surface should be smooth and without any damage, debris, rust or other contaminants. Apply grease to all the parts prior to assembly.

- 6.1 If the stroke adjustment stop (14) has been removed from the pinion (13) insert it back making sure the orientation of the two stop protrusions are at 45° to the Namur slot as shown in the drawing below. Use the two grooves which are cast on the bottom plane to identify the stop orientation.

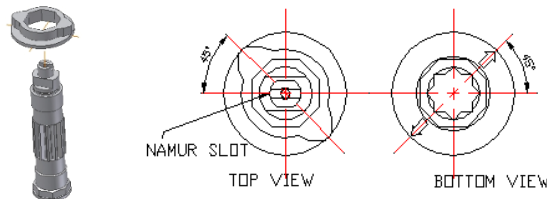

- 6.2 Fit the thrust washer (15) and pinion bottom O-ring (16) to the pinion (13) and stroke adjustment stop (14).
- 6.3 Insert the pinion assembly into the body. Make sure that the thrust washer tongue engages to the opposing groove in the body.

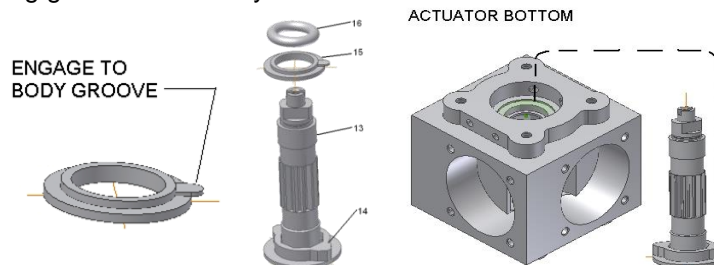

- 6.4 When inserting the pinion to the body, position the grooves of the stop perpendicular to the adjustment screws to ensure correct angle of rotation. Rotate the pinion CCW until the protrusion flats hit the adjustment screws and the grooves line up with the threaded holes as shown below.

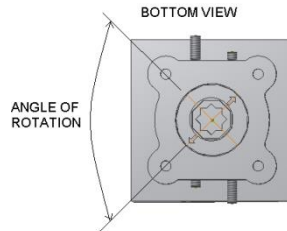

- 6.5 Fit the pinion O-ring (16), thrust washer (15) and disc bearing (18) to the pinion. Make sure that the thrust washer tongue engages to the opposing groove in the body.
- 6.6 Insert the snap ring onto the pinion. If the pinion does not protrude high enough, make sure that the bottom thrust bearing tongue has properly engaged into the body groove and the stroke adjustment stop is recessed in the body. Install the indicator (21) back on to the pinion and secure with the indicator screw (22).

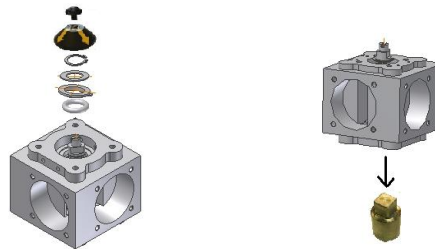

- 6.7 Place the assembled body with the pinion on the valve coupler clamped in the vise for inserting the pistons back in the cylinders.
- 6.8 Looking from the top of the actuator, rotate the body 90°CW and another 40° to bring it to the position for inserting the pistons.

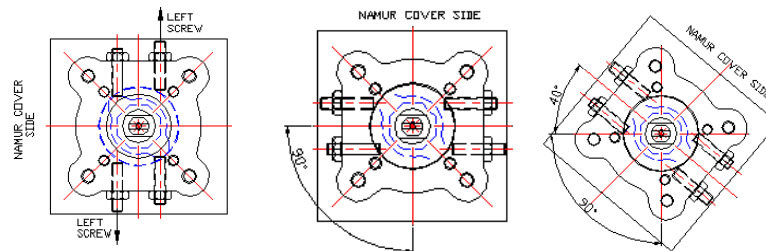

- 6.9 Assemble the O-rings on the pistons.
- 6.10 Apply grease in the body cylinders, to the pistons groove and rack and to the piston O-rings.
- 6.11 Insert the four pistons in the cylinders, keeping the orientation of the racks so the teeth engage with the pinion teeth.
- 6.12 Holding all 4 pistons with both hands as shown, rotate the body CCW until it stops against the adjustment screws and all 4 pistons are pulled inside. Make sure all the 4 pistons have reached the same position in the cylinder.

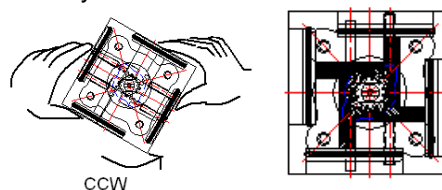

- 6.13 Rotate the body back 90°CW to the open position so the pistons are now almost flush with the actuator body. Apply a drop of removable thread sealant or lock to the two adjustment screws that were backed out and screw them back in until they both touch the stop. Adjust them until you visually see that the pinion flats are parallel with the body plane.

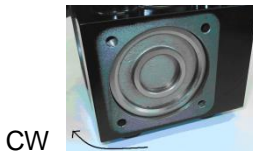

- 6.14 Rotate the body back and forth to get the pistons running smoothly in the cylinder.
- 6.15 Bring the pistons into the closed position and once again apply grease in the cylinders behind the pistons.
- 6.16 Apply grease to all the spring sets.
- 6.17 Push the cover O-ring in the groove of the covers. If needed, replace them with a new set. Notice that the Namur cover has an additional small O-ring that should be in place.
- 6.18 Lubricate the cover screws
- 6.19 Assemble the Namur cover first. If this is a SR actuator, place the spring set in the cover and then screw down the spring cover.



- 6.20 Always tighten the screws in sequence.
- 6.21 Assemble the DA covers. Make sure the covers are put back according to your marking during disassembly.
- 6.22 Assemble the SR covers with the spring sets. The screws are long enough to engage to the thread before the springs start to compress. Tighten the screws in sequence and only two turns at a time.

Actuator Testing

After completion of the actuator assembly it is required to follow these testing procedures to ensure the actuator has been assembled correctly and to minimize the risk of personal injury.

Pneumatic Leak Test

The pneumatic test checks for leakage across the pistons or to environment. Use commercial leak testing solution to check for leakage to atmosphere. The leak testing pressure will be 80 psig (5.5 barg). Use a calibrated pressure regulator to apply pressure to the actuator. **Warning: Do not exceed the maximum operating pressure rating listed on the nameplate.** Cycle the actuator at least 5 times to allow the seals to find their position before commencing with the leak test.

Piston Leakage

Any leakage across the piston is not acceptable.

- 1.0 Apply the pressure to port A and leave port B open.
- 2.0 Apply a leak testing soap solution to port B and check for leakage.

- 3.0 For DA actuators repeat this applying pressure to port B and check port A for leakage.
- 4.0 If Leakage is observed, disassemble the actuator again and check the seal, surface finish and cleanliness of the internal parts to find the cause of leakage. After doing the repair work, the leakage test must be performed again.

External Leakage

For SR actuators apply the pressure to port A and leave port B open. For DA actuators apply the pressure to port A and B. After applying pressure, wait a few seconds to let the pistons stabilize and then check for leakage. Apply the leak testing solution to the pinion output. For DA actuators apply the leak testing solution to the covers.

PARTS AND IDENTIFICATION

Fig. 8

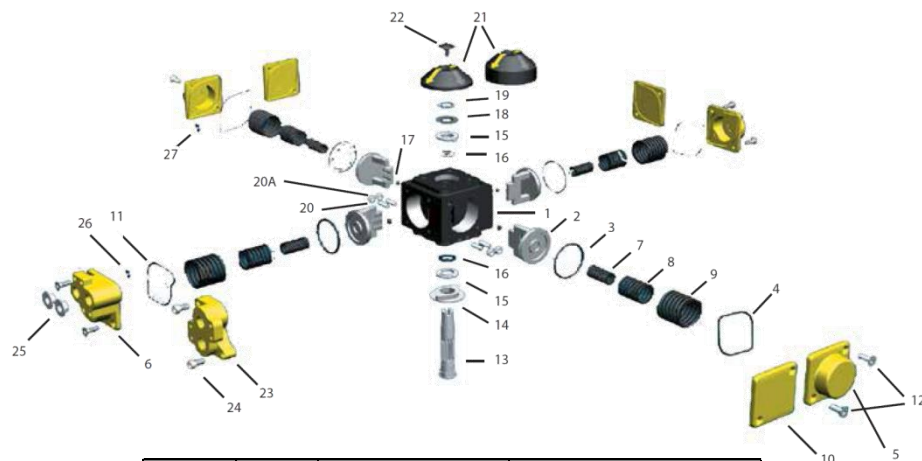

Part No.	Qty	Part Description	Standard Materials
1	1	Body	Aluminum AL 356-T6
2	4	Piston	Carbon Steel S45C Nickel Plated
3*	4	Piston "O" Ring	NBR
4*	3	Cover "O" Ring	NBR
5	3	Spring Return Cover	Aluminum Al 380
6	1	NAMUR Cover	Aluminum AL 380
7	Max 4	Inner Spring	Painted Spring Steel
8	Max 4	Middle Spring	Painted Spring Steel
9	Max 4	Outer Spring	Painted Spring Steel
10	3	Double Acting Cover	Aluminum AL 380
11*	1	NAMUR Cover O" Ring "	NBR
12	8,16 or 18	Cover Screw	Stainless Steel 304
13	1	Pinion	Steel
14	1	Stroke Adjustment Stop	Stainless Steel 304
15*	2	Thrust Washer	POM
16*	2	Pinion "O" Ring	NBR
17*	4	Pad	POM
18	1	Disc Bearing	Stainless Steel 304
19	1	Snap Ring	Stainless Steel 304
20	4	Stroke Adjustment Stud	Stainless Steel 304
20A	4	Nut	Stainless Steel 304
21	1	Indicator	ABS
22	1	Indicator Screw	C15
23	1	NAMUR Insert (X115)	AL 380
24	2	Bolt (X115)	Stainless Steel 304
25	2	Plug	Plastic
26*	1	Air Supply O-Ring	NBR
27*	7(X90) 8(X115)	Small End Cap O-Ring	NBR

* Parts Typically Supplied in Service Kits

It is the responsibility of the customer to determine the suitability of Sharpe® Valves products in their particular application.
Disclaimer: Supplier shall not be liable or responsible for omissions or errors in its bulletin.