

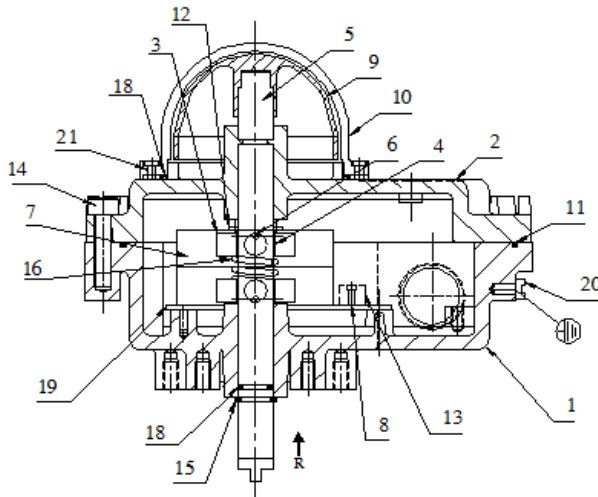

## Installation, Operation, and Maintenance Manual

# Sharpe Limit Switch

**MODEL: SLXS4MH10, SLS9MH10, SLXS4PPF8, SLS9PPF2**



21	PHILIPS HEAD SCREW	4	S.S.304
20	SCREW FOR BATHING	2	S.S.304
19	PCB	1	-
18	O RING	2	NBR
17	O RING	1	NBR
16	SFRING	1	S.S.302
15	BTYPB CIRCLIP	1	SF STEEL
14	SCREW FOR COVER	8	S.S.304
13	SCREW FOR CONN. STRIP	2	S.S.304
12	S CREW FOR MICROSWITCH	2	S.S.304
11	GASKET	1	NBR
10	INDICATOR COVER	1	POLYCARBONATE
9	INDICATOR	1	ABS
8	CONNECTOR STRIP-SWAY.	1	PA6
7	MICROSWITCH (DFDT)	2	HONEYWELL CHERRY
6	SPRING DOWEL	2	SF STEEL
5	SHAFT	1	S.S.304
4	CAM-LOCK	2	POM
3	CAM	2	PA6
2	COVER	1	AL (LM-6)
1	HOUSING	1	AL (LM-6)
S.NO.	DESCRIPTION	QTY.	MATERIAL

### WARNING AND SAFETY INSTRUCTIONS:

1. Read this Installation, Operation & Maintenance manual before using the actuator.
2. Sharpe Valves cannot anticipate all of the situations a user may encounter while installing and using the Sharpe Limit Switch. The user must know and follow all applicable industry specifications on the safe installation and use of the switch. Only qualified personnel or technicians who are trained for maintenance work and have read the instructions are to assemble and disassemble the switch. Misapplication of the product may result in injuries or property damage.
3. Before operating a limit switch which is connected to a valve in the pipeline, make sure you know the valve function.
4. Make sure the limit switch is not connected to the air supply or electrical system before attempting to do any maintenance.
5. Use only the Sharpe Limit Switch components and spare parts.
6. The user must follow and observe any national or local safety law imposed for



for his system.

### STORAGE

The Sharpe Limit Switch has been packaged to provide protection during shipment and storage. It is however, possible that the Limit Switch can be damaged during transport. Inspect Limit Switch for shipping damage prior to storage. The box should be left in the original packing until it is required for the use. It should be stored in the enclosed area in a clean dry environment with the temp limit 4 to 40c until ready for use. Keep plastic plugs in the air ports to prevent liquids or other materials from entering the housing during storage.

### SUPPLY PRESSURE

The supply pressure for the Sharpe Limit Switch are as follows:  
2-8 barg (30-120 psig)

### SPECIFICATION OF THE LIMIT SWITCH BOX

The limit switch is provided with the interface in accordance with ISO 5211. The products are also approved under explosion risk as per UL 1203 & UL508.

### IDENTIFICATIONS

Limit switch box label shows the following:

- \*Model
- \*Classification
- \*Instruction
- \*Current rating, voltage rating
- \*Manufacturing date
- \*Brief address

### OPERATING PRINCIPLE

The shaft of the limit switch is engaged with the shaft of the actuator (or any other rotary device), on rotation of the actuator shaft the limit switch shaft rotates and thus provides the electrical and visual signal as desired.

### INSTALLATION PROCEDURE

The equipment must be installed in the accordance with the laws, guide lines and rules applicable within the country of use.  
The current and voltage limitation has to be observed as per the tag plate.  
The wiring and the connection should be carried out to avoid the water seepage or moisture from going inside the housing. Use proper electrical conduits.  
The limit switch comes with the bracket and screws.  
When installing the switch with the bracket, make sure the shaft enters in the slot of the actuator pinion slot. Install the bracket screws to the actuator.  
Now align the limit switch box in line with the body of the actuator and tighten all the screws.  
Connect the wiring through the cable gland required by the cable diameter. And connect wires to the terminal strip.  
Take care to check the symbols on the PCB. The switch 1 is at the bottom and the switch 2 is on the top.  
COM1, NO1, NC1 corresponds to switch 1.

COM-common terminal  
NC-normally closed contact opens when actuated  
NO-normally open contact closes when operated



## SETTING OF CAMS

The setting of cam is a crucial operation.

The cams are self-locking due to the male female gears perfectly matching. The top cam is red in color and is to be used for setting the closed position. Actuate the assembly so as the valve closes. Now rotate the cam, by depressing the cam downward, in the direction of the actuator rotated to close the valve, continue the rotation till the click on the micro-switch is heard. Alternatively, if you are permitted to check while the supply is on check the potential dropping to zero across the COM and NO. this is the final position for the close switch. Operate the actuator to bring the valve in the open position. The cam has to be lifted and rotated till the click in the micro-switch is heard.

Now close the cover make sure the gasket is in the position and all fasteners are on the covers. Insert the top end of the shaft in the cover so it touches the indicator. Rotate the cover until the cover slides down. Align the cover and body and tighten the bolts fully. It is mandatory to tighten all the fasteners.

The top dome can be set if required to the position so as full yellow or full red is visible. The dome has a possibility of adjustment up to 10 degrees on either side. Check the position of the valve to the position of the indicator and the condition should match.

## MAINTENANCE

The limit switch must be removed from the installation prior to maintenance. All wiring and supply has to be disconnected prior to disassembly.

All the spares used or replaced must be originals from Sharpe Valves. It is important to verify the model/version of the limit switch box and spares to be replaced. In case of difficulty consult Sharpe Valves.

## DISASSEMBLY

Loosen all 4 cover bolts item 14 in BOM. Pull out the cover vertically. Note that the shaft is still in the housing. Dismantle the screw no.12 and 13 PCB (printed circuit board) no.19 can be taken out. The cover comes out loose with that. Now you can access the switches. Use a multi meter to locate the error by using the zero resistance method.

The ohmic value should be less than 0.2 ohms. In case of burnt contact, the contacts may show more resistance or may show open contact.

Replace the PCB completely with the switches.

The circlip (retaining ring) part no.15 should be removed to bring the shaft out from the box. Check for o-ring and cam damage. Replace the shaft or the o ring as required.

Top dome and indicator comes out by opening the screw no.22 observe the o ring 23 for the weathering effect. Replace the parts as required. It is advisable to replace all the rubber parts together. All parts are included in the set of kit.

## ASSEMBLY

\*Install the shaft in the housing with grease as a lubricant.

\*Install the circlip. Check the rotation by hand and check for the play. The play should be less than 0.05mm.

If the play is more it is not safe to install the box.

\*Install the PCB and the switch cover, fasten four screws to ensure no movement of PCB is possible. This may cause the faulty signal.

\*Rotate the cam to ensure that the cam is clicking the switch correctly.

\*Check the surface of the casting and the surface of the cover. There should not be any mark within the flame path area. It is important if the surface is found faulty must be consulted with an expert on EN norms to certify the usage.

\*Insert the cover on the shaft. The shaft has to be lightly lubricated. Bring the cover fully down. Tighten all the bolts no.14 check with the slip gauge of size 0.05mm. It should not enter from any face joint area. In case it does the face cannot be used.

\*Repack the limit switch box to safe storage.



**WIRING DIAGRAM:**

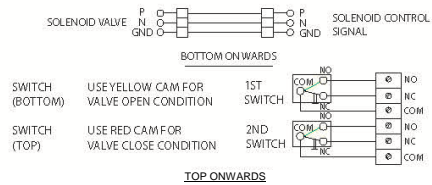
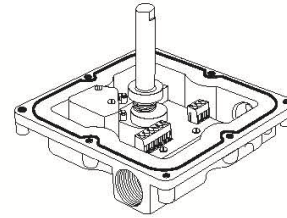
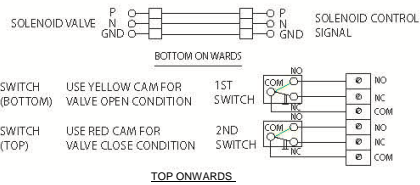
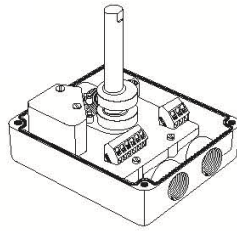

**SLXS4MH10 (NEMA 4 MECHANICAL)**

**SLXS9MH10 (NEMA 7/9 MECHANICAL)**

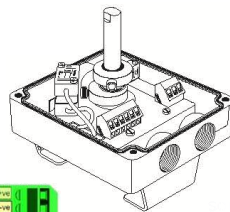

Old Style Board Wiring

New Style Board Wiring

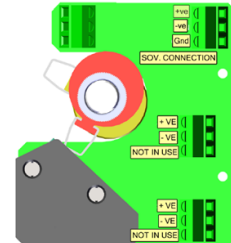
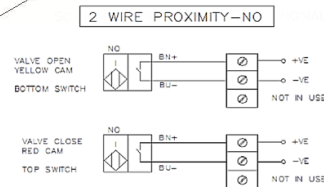
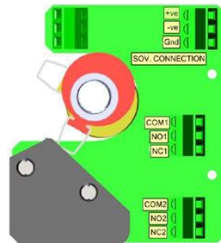
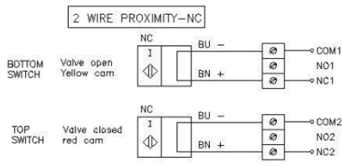

**SLS4PPF8 (NEMA 4 PROXIMITY)**

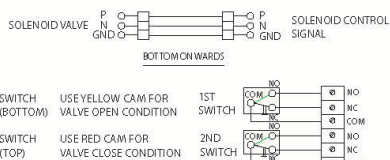
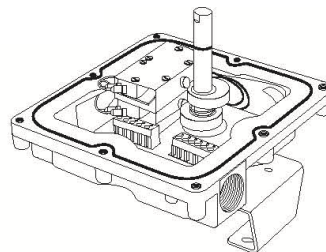

**SLS9PPF2 (NEMA 7/9 PROXIMITY)**