

Building connections that last™



# Anvil®

## Oil & Gas Products





## ***Dedicated to Customer Service***

**888-861-7827 · [energysales@anvilintl.com](mailto:energysales@anvilintl.com)**

### ***Irving, TX***

1401 Valley View Lane, Suite 150, Irving, TX 75061

### ***Odessa, TX***

1100 West I-20, Odessa, TX 79763

### ***Houston, TX***

6999 Old Clinton Road, Houston, TX 77020

***Building Connections That Last*** 

We seek to set a new standard in product performance, customer service, and technical support. Our value proposition is clear. The Anvil team will meet and surpass industry requirements in manufacturing, distribution, and service in support of every customer – every time.

## TABLE OF CONTENTS

### Swages, Bull Plugs, Tubing & Casing Nipples

Bull Plugs.....	4
Line Pipe Swages.....	4
Oil Country Swages.....	4
Tubing Nipples.....	4
Casing Nipples.....	4

### Catawissa® Wing Unions

Fig. 100.....	6
Fig. 200.....	6
Fig. 202.....	6
Fig. 206.....	6
Fig. 211.....	6
Fig. 300.....	6
Fig. 301.....	6
Fig. 400.....	6
Fig. 600.....	6
Fig. 602.....	7
Fig. 607.....	7
Fig. 1002.....	7
Fig. 1502.....	7
Fig. 100C.....	7
Fig. 200C.....	7
Fig. S1A.....	7
Fig. 3L S1A.....	7

### Gruvlok® Valves

Series 7500 Ball Valves.....	8
Series 7700 Valves.....	8

### Gruvlok® Couplings

Fig. 7004 HPR Coupling.....	9
Fig. 7004 EG Coupling.....	9
Fig. 7305 HDPE Coupling.....	9
Fig. 7307 HDPE Transition Coupling.....	9
Fig. 7402 SlideLOK™ Coupling.....	9
Fig. 7000 Lightweight Flexible Coupling.....	10
Fig. 7400 RigidLite™ Coupling.....	10
Fig. 7005 Roughneck™ Coupling.....	10
Fig. 7003 Hingelok™ Coupling.....	10
Fig. 7010 Reducing Coupling.....	10

### Gruvlok® Fittings

Fig. 7012 Flange.....	11
Fig. 7788 Flange Adapter.....	11
Gruvlok High Pressure End Guard Fittings	11
Gruvlok Plain-End Fittings.....	11-13

### Gruvlok® Gasket Selection Guide..

### Oilfield Couplings

Carbon Steel Merchant Couplings.....	15
JB Smith Sub & Comb. Couplings.....	15
API Line Pipe Couplings.....	15

### Forged Steel Fittings and Nipples

Steel Pipe Nipples.....	15
Forged Steel Fittings.....	16
IPC Coatings.....	16
Pumping Tee.....	16

### Anvil Pipe Hangers

Fig. 264 Pipe Stanchion.....	17
Fig. 259 Pipe Stanchion Saddle.....	17
Fig. 295 Double Bolt Pipe Clamp.....	17

### Anvil-Strut

Strut and Strut Fittings.....	18-19
-------------------------------	-------

### H-Block Supports.....

### Anvil Design Services.....

### Terms and Conditions.....

## INDUSTRY AND GOVERNMENT STANDARDS & APPROVALS



ANSI	American National Standards Institute	COE	Corps of Engineers: CEGS 15000
AWWA	American Water Works Association: C-606	FAA	Federal Aviation Administration: HVAC, Plumbing, Fire Protection
API	American Petroleum Institute: API Std.5L, Sect.7.5	FHA	Federal Housing Administration
ASHRAE	American Society of Heating, Refrigerating and Air Conditioning Engineers	GSA	General Services Administration:15000 Series
ASME	American Society of Mechanical Engineers: Power Piping, B-31.1;Chemical Plant and Petroleum Refinery Piping, B-31.3;Refrigeration Piping, B-31.5; Building Services Piping, B-31.9; Slurry Pipelines, B-31.11	MIL	Military Specifications: MILP-10388 Fittings;MIL-C-10387 Couplings; MIL-P-11087A(CE) Steel Pipe, Grooved MIL-I-45208 Inspection Procedure
ASTM	American Society of Testing and Materials:F-1476, F-1387	NASA	National Aeronautics and Space Administration:15000 Series
BBA	British Board of Agreement	NAVFAC	Naval Facilities Engineering Command:NFGS 15000 Series
CDF	California State Fire Marshal	NIH	National Institute of Health (Dept. of Health):15000 Series
CSA	Canadian Standards Association:B-242	TVA	Tennessee Valley Authority:Fire protection, storm drains
FM	Factory Mutual Engineering Corp.	VA	Veterans Affairs :15000 Series
IAPMO	International Association of Plumbing & Mechanical Officials		
LLOYD 'S	Lloyd 's Register of Shipping	Worldwide	
MEA	Materials &Equipment Acceptance	BV	Bureau Veritas
NFPA	National Fire Protection Association	DNV	Det Norske Veritas
NY-BSA	New York Board of Standards and Appeals		Hong Kong Fire Services Board
NSF	NSF International		New Zealand Insurance Council
SBCCI	Southern Building Code Congress International: Standard Plumbing and Mechanical Code		New Zealand Building Act. (1991)
UL	Underwriter's Laboratories, Inc.	SSL	Scientific Services Laboratory
ULC	Underwriter's Laboratories of Canada	Standards Australia	
	Bureau of Marine Inspection:Salt and fresh water, oil transfer	VdS	Verband der Sachversicherer e. V.
	Bureau of Public Roads;Div. of Bridges:Drain lines and bridge crossings	LPC	Loss Prevention Council
Canadian Coast Guard		WRC	Water Research Council
U. S. Coast Guard – Approves each vessel individually		DVGW	Deutscher Vereindes Gas und Wasserfaches e. V.
ABS	American Bureau of Shipping	BBA SM	Board of Agremont



# Swages, Bull Plugs, Tubing & Casing Nipples

J.B. Smith is the leading manufacturer of oil country tubular fittings, swages, and bull plugs. J.B. Smith is dedicated to a continuous quality improvement process to help maximize all aspects of the company to service our customers.

## Full Traceability:

All J.B. Smith swages, bull plugs, tubing and casing nipples, and chambers are traceable to the original mill test report. To ensure the traceability all fittings are steel stamped as follows:

## Material Specifications:

JBS manufactures stamps with material grades:  
Line Pipe - A106, Carbon Bar, LF2, 304, 316  
Oilfield - K55, J55, N80, L80, P110 etc.

## Raw Material Code :

Each is stamped with a four letter code for identifying raw material type, details of purchase, and mill test report.

## Bull Plugs

Sizes range  $\frac{3}{4}$ " -  $10\frac{3}{4}$ ".

2" and smaller bull plugs are manufactured out of cold drawn bar, which is heat treated in accordance with ASTM A234.

2 $\frac{1}{2}$ " -  $10\frac{3}{4}$ " bull plugs are manufactured out of A106 Grade B seamless pipe using J.B. Smith's unique spinning process, which ensures uniform wall thickness. Bull plugs are available in standard, extra heavy, double extra heavy, schedule 160, or solid. All Smith bull plugs can be tapped. End finishes available are current API threads, beveled for weld, square cut (socket weld) or grooved.



## Line Pipe Swages

Sizes range  $\frac{1}{8}$ " - 10". Swages are manufactured out of A106 Grade B seamless pipe or carbon bar, which is manufactured in accordance with ASTM A234 WPB. Choice of raw material is dependent on size and reduction. Swages are manufactured in standard, extra heavy, double extra heavy or schedule 160. End finishes available are current API threads, beveled for weld, square cut (socket weld) or grooved. All line pipe swages are available concentric and eccentric.

## Oil Country Swages

1" through  $10\frac{3}{4}$ " O.D. are MFG.

## Tubing Nipples

Size 1-4 upset and non-upset ends. Lengths are 4" - 36". Tubing nipples are available with any combination of current API threads (8 round, 10 round, 11 $\frac{1}{2}$ v, etc.) and are stock items in J-55, K-55, N-80 and L-80. Wall thicknesses available are standard through double extra heavy. For a different grade of material (stainless, brass, etc.) and different threads, consult factory.

## Casing Nipples

4 $\frac{1}{2}$ " O.D. -  $10\frac{3}{4}$ " O.D.

## Heat Treatment:

JBS fittings are manufactured to meet heat treatment requirements of applicable specification for product manufactured.

Line Pipe Specification ASTM-A234 WPB  
Oilfield specification API 5CT

JBS manufactures to the following specifications:

API 5B	License Threading
API 5CT	License Casing, Tubing and Accessories
ANSI B16.9	Weld Bevels
MSS-SP-95	Swages & Bull Plug
ASTM A234-WPB	Line Pipe Fittings
ASTM B633 Type III	Zinc Electroplate
Charpy Impact	As Required
N.A.C.E. MR-01.75	As Required
D.N.V.	As Required
ISO 9001	Certified





**Catawissa™**  
PERFORMANCE UNDER PRESSURE

# Wing Unions

Catawissa has been a leading manufacturer of quality industrial Forged Steel and Oilfield Wing Unions since 1942. Our Oilfield Wing Union products range in size from 1" to 8" and include the standard ball and cone design plus our unique Figure 300 Flat Face design, where space and pipe line separation are a consideration.

## Full Traceability:

All Catawissa Oilfield Wing Unions are fully traceable and are available with complete mill certifications upon request.

## Interchangeability:

All Catawissa Oilfield Wing Unions are machined to rigid quality standards ensuring that like components of the same size, figure number and pressure rating are fully interchangeable in the field. Catawissa Oilfield Unions are interchangeable with most leading union manufacturers.

## Full Range of End Connections:

Catawissa Oilfield Wing Unions are also available in threaded ends as well as butt weld and non-pressure seal ends. When you choose Catawissa you receive the utmost in quality, the widest selection and unmatched on-time deliveries.

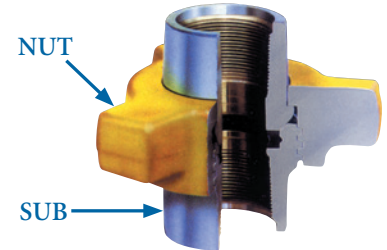

## Product Availability Quick Reference Chart

Fig No.	Standard Service		Pipe Size (in.)								
	CWP SUB	Test NUT	1	1¼	1½	2	2½	3	4	6	8
100	1,000	1,500				✓	✓	✓	✓	✓	✓
200	2,000	3,000	✓	✓	✓	✓	✓	✓	✓	✓	
202	2,000	3,000							✓		
206	2,000	3,000	✓	✓	✓	✓	✓	✓	✓	✓	
211	2,000	3,000	✓			✓					
300	2,000	3,000	✓			✓	✓	✓	✓		
301	3,000	4,500	✓			✓		✓			
400	4,000	6,000				✓		✓	✓		
600	6,000	9,000	✓		✓	✓		✓	✓		
602	6,000	9,000	✓		✓	✓		✓	✓		
607	6,000	9,000			✓	✓					
1002	10,000	15,000	✓		✓	✓		✓	✓		
1502	15,000	22,500				✓		✓			
100C	1,000	1,500				✓					
200C	2,000	3,000	✓			✓					
S1A High Speed	3,000	4,500	✓			✓		✓			
3L S1A Tri-Lug	3,000	4,500	✓		✓	✓					



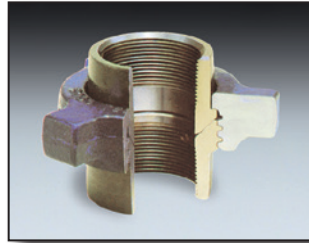

**Figure 100**

1,000 PSI CWP - 1,500 PSI Test

Sizes: 2" - 8"

Low pressure service. Manifold and general service. Female threaded ends. 2" available with 8RD thread. Consult Factory.



**Figure 200**

2,000 PSI CWP - 3,000 PSI TEST

Sizes: 1" - 6"

A general purpose union. Threaded and butt weld ends available.



**Figure 202**

2,000 PSI CWP - 3,000 PSI TEST

Size: 4"

O-Ring seated dead-end cap. Perfect for transport and completion and stimulation services.

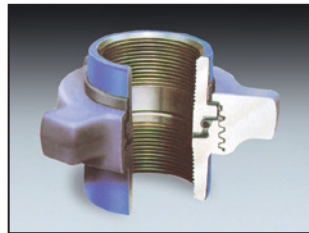

**Figure 206**

2,000 PSI CWP - 3,000 PSI TEST

Sizes: 1" - 10"

O-Ring in male sub for improved sealing. Available in threaded and weld ends.



**Figure 211**

2,000 PSI CWP - 3,000 PSI TEST

Sizes: 1", 2"

Insulating Union. Laminated rings provide full insulation from electrolytic corrosion. Total of 35 million Ohms resistance. O-Ring in male sub and seal ring female sub provide primary and secondary seals. All seal rings are field replaceable. Available in threaded and butt weld ends.



**Figure 300 - Flat Face**

2,000 PSI CWP - 3,000 PSI TEST

Sizes: 1" - 4"

Unique Flat-Face Design permits lateral removal of valves and fittings without line spreading.



**Figure 301**

3,000 PSI CWP - 4,500 PSI TEST

Sizes: 1", 2", 3"

Ideal Steam Service Union.



**Figure 400**

4,000 PSI CWP - 6,000 PSI TEST

Sizes: 2", 3", 4"

Ideal for manifold and pumping service. Available in threaded and weld ends.



**Figure 600**

6,000 PSI CWP - 9,000 PSI TEST

Sizes: 1" - 4"

Features bronze seat for primary seal to prevent rust and corrosion conditions in well servicing and drilling. Available in threaded and weld ends.



**Catawissa™**  
PERFORMANCE UNDER PRESSURE

# Wing Unions

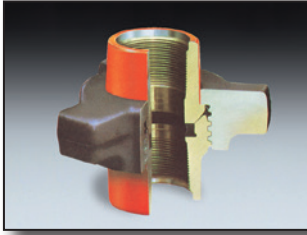

**Figure 602**

6,000 PSI CWP - 9,000 PSI TEST

Sizes: 1" - 4"

Compact design is well suited for manifold service. Lip type elastomer seal protects the metal to metal seal. Seal design reduces line turbulence. Available in threaded and welded ends.

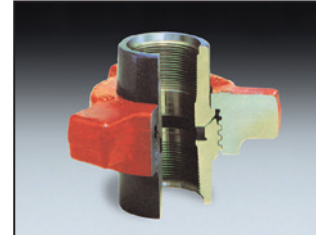

**Figure 607**

6,000 PSI CWP - 9,000 PSI TEST

Sizes: 1 1/2", 2"

Ideal for hot oil trucks and any application similar to Figure 602. Extended Subs allow for quick breakout on trucks and manifolds. Metal to metal connection.

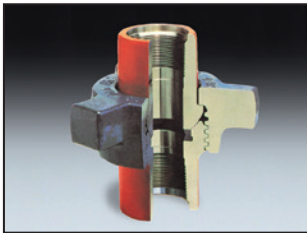

**Figure 1002**

10,000 PSI CWP - 15,000 PSI TEST

Sizes: 1" - 4"

Alloy steel forgings for use in high pressure manifold and treating iron connections. Field replaceable lip-type elastomer seal protects the metal to metal seal. Available in threaded and welded ends.



**Figure 1502**

15,000 PSI CWP - 22,500 PSI TEST

Sizes: 1 1/2", 2", 3"

Alloy steel forgings for use in high pressure manifold and treating iron connections. Field replaceable lip-type elastomer seal protects the metal to metal seal. Available in threaded and welded ends.

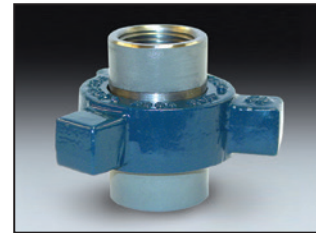

**Figure 100C** **IMPORT**

1,000 PSI CWP - 1,500 PSI Test

Size: 2" Lug Union

Ideal for low-pressure service. Manifold and general service. Female threaded ends.

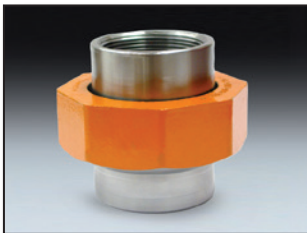

**Figure 200C** **IMPORT**

2,000 PSI CWP - 3,000 PSI Test

Sizes: 1" & 2" Lug Union

General purpose union. Available in threaded ends.



**Figure S1A**

**High Speed Union**

3,000 PSI CWP - 4,500 PSI TEST

Sizes: 1, 2", 3"

3000# FS UNION. Female threaded ends.

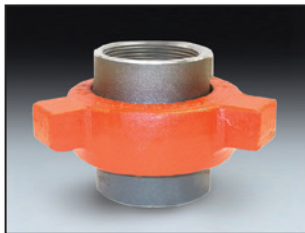

**Figure 3L S1A**

**Tri-Lug High Speed Union**

3,000 PSI CWP - 4,500 PSI TEST

Sizes: 1, 1 1/2", 2"

3000# FS UNION. Tri-Lug with female threaded ends.





## Gruvlok Series 7500 Ball Valves

The Series 7500 grooved-end ball valve line consists of a 2" to 6" standard port, two piece design, and is available in configurations to address a broad spectrum of application requirements.

The Series 7500 has generous factors of safety for pressure retention and stem torsional strength. In addition, it has a blow-out proof stem design, low operating torque, and high Cv.

The Series 7500 is compliant with NACE MR01-75 when stainless steel trim is specified.

Grooved ends conform to the requirements of AWWA C606 for steel pipe. Stainless steel and special configurations available.

## Gruvlok Series 7700 Valves

For use in grooved end pipe systems

Sizes: 2"–12"

### FEATURES:

- 300 psi bubble-tight shutoff with Dead-End Service at full rated pressure.
- Constant DISC-TO-SEAT loading provided by unique spherical bore of disc seat area.
- Increased valve life with low operating torques.
- Thin profile disc provides outstanding flow characteristics and precise flow control.
- Strong stem to disc connection for unparalleled durability
- Secure one-piece ductile body for strength and impact resistance.
- Versatile nylon coated body inside and out for full corrosion protection.
- Elastomer encapsulated disc provides excellent chemical resistance for a range of applications.
- EPDM or Nitrile disc coatings standard with other body coating options available
- Standard lockable handle of ductile iron and plated steel for sturdiness



## GRUVLOK® Couplings

Gruvlok has grown from the early days of standard couplings and fittings to today's broad range of grooved product, plain end product, valving, pipe preparation tools, and various accessories.

- Provides flexibility above ground and below
- Reduces pipe assembly time 50% or more
- Provides union at every joint for easy retrofit and maintenance
- Leak tight joints

Gruvlok couplings for grooved end pipe are available in nominal pipe sizes 1" through 30" and in metric sizes. The variety of coupling designs provides a universal means for the connection of pipe, fittings, and pipe system components. The wide assortment of Gruvlok couplings and gaskets permits selection of the most suitable combination for a specific application, thus providing the most versatile and economical pipe installation.

### Material Specifications:

#### Housing:

Ductile Iron conforming to ASTM A-536, Grade 65-45-12

#### Gaskets:

EPDM, Nitrile, Fluoro Elastomer, Silicone with properties as designated in accordance with ASTM D-2000 for each gasket grade. EG gaskets are available in high modulus Grade T Nitrile elastomer only.

# GRUVLOK® Couplings

## Gruvlok Figure 7004 Coupling

Is designed to provide the versatility of a grooved joint while providing a connection for rigid pipe joint applications. The Fig. 7004 coupling permits working pressure ratings up to 1000 psi (68.9 bar).

Working Pressure and End Load Values are based on grooved standard wall pipe. Fig. 7004 provides a basically rigid joint and does not allow for expansion or contraction. Available 2" – 12" nominal pipe sizes.

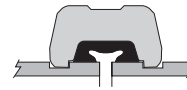

Fig. 7004 with standard gasket



## Gruvlok Figure 7004 Coupling with EG® Gasket

Uses the specially designed "END GUARD" gasket with "EG" grooved pipe. The "EG" gasket has a center rib that extends between the pipes to provide for pipe end protection, which makes it ideally suited for internally lined or coated pipe applications.

The Fig. 7004 Coupling with EG® Gasket permits working pressure ratings up to 2500 psi (172.4 bar). Working Pressure and End Load Values are based on "EG" cut grooved extra heavy steel pipe. Fig. 7004 provides a basically rigid joint and does not allow for expansion or contraction. Beveled end pipe should not be used with "EG" gaskets. Available 2" – 12" nominal pipe sizes.

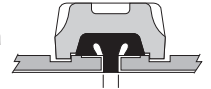

Fig. 7004 with "EG" gasket

## Gruvlok Figure 7305 HDPE Coupling

Is designed for mechanically joining HDPE (high density polyethylene) pipe and fittings. Each coupling uses four bolts to drive the sharply machined housing teeth into the outside of the pipe. The teeth are arranged in two banks, each bank consisting of at least two rows of spiral teeth. These effectively grip the pipe, providing a secure mechanical joint with pressure capabilities exceeding that of the HDPE pipe itself. Available in 2"-12" diameters.



## Gruvlok Figure 7307 HDPE Coupling

Allows for transition from HDPE pipe or fittings to grooved end pipe prepared per Gruvlok standard cut or roll groove specifications for steel pipe or Gruvlok fittings. Machined teeth engage specifically grooved steel pipe or fittings. The banks of teeth on one side of the housing are positioned away from the gasket, enhancing the sealing capability of the gasket. Temperature and pressure capabilities exceed the highest temperature and pressure ratings of the HDPE pipe. Available 2" – 12" nominal pipe sizes.

## Gruvlok Figure 7402 SlideLOK™ Ready for Installation Coupling

The CTS SlideLOK coupling is a ready for installation coupling designed to reduce installation time. The slide action allows for greater flexibility during installation. The patented gasket provides four separate sealing surfaces for added protection. The engineered metal-to-metal installation requirement is a quick and easy indication of proper assembly. Figure 7402 is designed to be used with roll groove or cut groove steel pipe, as well as with grooved light wall pipe, Gruvlok grooved-end fittings, and valves. The SlideLOK coupling produces a secure, rigid pipe joint connection, and allows for a maximum working pressure of 750 psi on roll or cut grooved standard wall pipe.





### Gruvlok Figure 7000 Lightweight Flexible Coupling

**Has a working pressure ratings up to 600 psi (41.4 bar).**

Fig. 7000 coupling is designed for applications requiring moderate internal pressures. The Fig. 7000 coupling is approximately 30% lighter in weight than the Fig. 7001 Coupling. Superior performance in FRAC and cement applications. Available 1" – 8" nominal pipe sizes.

### Gruvlok Figure 7400 RigidLite™ Coupling

The Figure 7400 Rigidlite Coupling from Gruvlok is specially designed to provide a rigid, locked-in pipe connection to meet the specific demands of rigid design steel pipe and copper tube systems. Fast and easy swing-over installation of the rugged lightweight housing produces a secure, rigid pipe joint. The Figure 7400 Rigidlite Coupling is UL Listed and FM Approved for 300 psi (20.7 bar) fire protection service in both wet and dry systems with roll grooved or cut grooved steel pipe prepared in accordance with Gruvlok grooving specifications. Provides rigidity in rig fire systems.

The Figure 7400 Rigidlite Coupling with a DRI-SEAL™ pre-lubricated gasket is intended for use in ambient temperature fire protection systems installed in accordance with NFPA Standard 13 "Sprinkler Systems". For other applications, optional EPDM and Nitrile gaskets are furnished. Available 1" – 8" nominal pipe sizes.



### Gruvlok Figure 7005 Roughneck™ Coupling

Is an efficient and cost effective method of joining either plain end or beveled end pipe. Gruvlok Plain End Couplings and Fittings allow a complete piping system to be installed without any pipe end preparation. The Gruvlok Plain End Method is especially suited for repair or cut-in work, as well as new installations where rigid joints are required. The Roughneck Coupling "grippers" bite into the outside diameter of the steel pipe, providing for positive rigid joint connections. Available in 2" - 16" diameters.

### Gruvlok Figure 7003 HingeLok™ Coupling

Is specially designed for applications requiring a quick connection and/or disconnection of a pipe joint. The two coupling halves are hinged for ease of handling and are secured by a cam-action handle. Sizes 1" to 4" use toggle link plates and sizes 5" to 8" use a toggle bolt to attach the cam-action handle to the housings. A locking pin through the handle prevents accidental opening of the coupling. The Fig. 7003 Hingelok Coupling allows working pressure ratings up to 300 psi (20.7 bar). Available with Viton and silicone gaskets for more critical services. An optional heavy-duty locking pin can be furnished on request. Available 1" – 8" nominal pipe sizes.



### Gruvlok Figure 7010 Reducing Coupling

The Figure 7010 Reducing Coupling makes it possible to directly connect two different pipe sizes, eliminating the need for two couplings and a reducing fitting. The specially designed reducing coupling gasket with a center rib assures proper positioning of the gasket and prevents the smaller pipe from telescoping into the larger during assembly. Figure 7010 Reducing Coupling allows for working pressure ratings up to 500 PSI (34.5 bar). ranges 15" of Hg. vacuum to 300 psig on standard wall steel pipe. Available 2" – 8" nominal pipe sizes.

# GRUVLOK® Fittings

Gruvlok fittings are available through 24" nominal pipe size in a variety of styles. Use the Fitting Size Table from the Gruvlok catalog to convert nominal pipe size to corresponding pipe O.D. These fittings are designed to provide minimum pressure drop and uniform strength. Refer to Flow Data in the catalog for details. Depending on styles and size, Gruvlok fittings are provided in various materials including malleable iron, ductile iron, forged steel or fabricated steel. Pressure ratings of Gruvlok standard fittings conform to those of Figure 7001 Gruvlok coupling.

## Gruvlok Figure 7012 Flange

Allows direct connection of Class 125 or Class 150 flanged components to a grooved piping system. The two interlocking halves of the 2" through 24" sizes of the Gruvlok Flange are hinged for ease of handling, and are drawn together by a latch bolt which eases assembly on the pipe. Precision machined bolt hole, key and mating surfaces, assure concentricity and flatness to provide exact fit-up with flanged, lug and wafer styles of pipe system equipment. A specially designed gasket provides a leak-tight seal on both the pipe and the mating flange face. The 14" through 24" sizes of the Gruvlok Flange are cast in four segments. A sleek profile gasket design allows quick and easy assembly of the Gruvlok Flange onto the pipe. All Gruvlok Fig. 7012 Flanges have designed-in anti-rotation tines which bite into and grip the sides of the pipe grooves to provide a secure, rigid connection. The Gruvlok Fig. 7012 Flange requires the use of a metal adapter insert when used against rubber faced surfaces, wafer/lug design valves and serrated or irregular sealing surfaces.

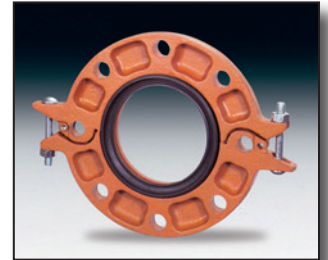

## Gruvlok Figure 7788 Flange Adapter

The Gruvlok Figure 7788 Flange Adapter allows for direct connection of Class 125 or Class 150 flanged components to a grooved piping system. The Gruvlok Flange Adapter provides an alternative method of connecting to flanged components than the traditional Figure 7012 Gruvlok Flange. The Gruvlok Flange Adapter provides a raised serrated face flange connection with a shorter overall length than Anvil's Figure 7084 Flange x Groove Nipple.

## Gruvlok High Pressure End Guard Fittings

Sizes: 2" – 6"

Gruvlok End Guard Fittings are fabricated from extra heavy (XS) materials. These fittings may be used for high pressure systems or where lined or coated fittings are required.

Available configurations: 90° and 45° elbows, tees, reducing tees, and crosses.



## Gruvlok Plain-End Fittings

Gruvlok plain end fittings are designed for use with the Fig. 7005 Roughneck Coupling only. Available in nominal pipe sizes through 8" in a variety of styles. Depending on size and configuration, fittings are either segment-welded steel or forged steel.



Gruvlok Figure 7050  
Standard 90° Elbow



Gruvlok Figure 7060  
Standard Tee



Gruvlok Figure 7072  
Concentric Reducer



## Material Specifications:

- ◆ **Cast Fittings:**  
Ductile iron conforming to ASTM A 536 or Malleable iron conforming to ASTM A 47
- ◆ **Fabricated Fittings:**  
1-4" Carbon steel, Schedule 40, conforming to ASTM A53, Grade B  
5-6" Carbon steel, Schedule 40 conforming to ASTM A53, Grade B  
8" Carbon steel, Schedule 30, conforming to ASTM A53, Grade B
- ◆ **Coating:**  
Rust inhibiting paint, ORANGE (Standard), RED (Optional)  
Hot-dipped zinc galvanized (Optional).  
For other coatings contact Gruvlok.

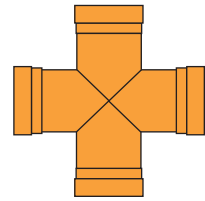

Gruvlok Figure 7068  
Cross

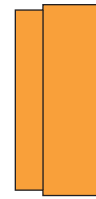

Gruvlok Figure 7074  
End Cap

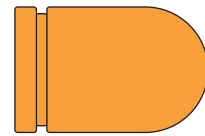

Gruvlok Figure 7075  
Bull Plug

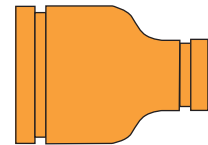

Gruvlok Figure 7077  
Swaged Nipple

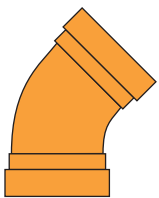

Gruvlok Figure 7051  
Standard 45° Elbow

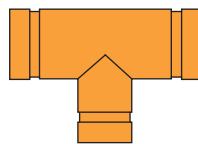

Gruvlok Figure 7061  
Reducing Tee

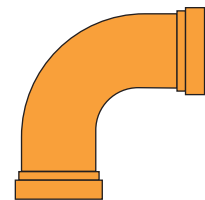

Gruvlok Figure 7050LR  
Long Radius 90° Elbow

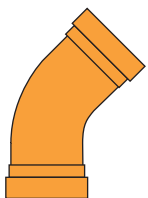

Gruvlok Figure 7051LR  
Long Radius 45° Elbow

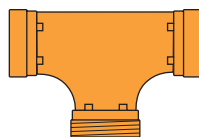

Gruvlok Figure 7063  
Threaded Tee

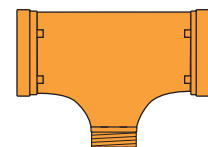

Gruvlok Figure 7064  
Reducing Threaded Tee

## Gruvlok Gasket Styles

Gruvlok offers a variety of pressure responsive gasket styles. Each serves a specific function while utilizing the same basic sealing concept. Proper installation of the gasket compresses the inclined gasket lips on the pipe O.D., forming a leaktight seal. This sealing action is reinforced when the gasket is encompassed and compressed by the coupling housings. The application of internal line pressure energizes the elastometric gasket and further enhances the gasket sealing action.

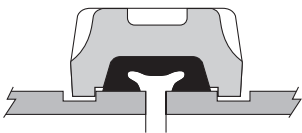
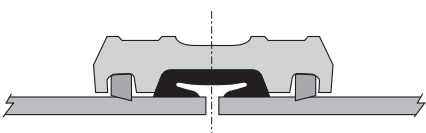
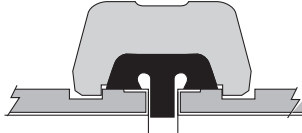

 <p><b>"C" Style</b></p> <p>The "C" Style cross section configuration is the most widely used gasket. It is the gasket style provided as standard in many Gruvlok Couplings (Fig. 7000, 7001, 7003, 7004HPR, 7307, 7400 and 7401). Grade "E" and "T" are standard grades while other grades are available for special applications.</p>	 <p><b>Roughneck®</b></p> <p>This "C" style gasket is similar in appearance and design to the Standard gasket but is only used with Fig. 7005 Roughneck Couplings and Fig. 7305 HDPE Couplings. The Roughneck gasket is wider, which allows for minor pipe end separation as line pressure sets the grippers into the plain end pipe.</p>	 <p><b>End Guard®</b></p> <p>The projecting rib fits between the ends of lined pipe to prevent damage to unprotected pipe ends during coupling joint assembly. The E.G. gasket is provided as standard with the Fig. 7004 E.G. Coupling. The E.G. gasket is available only in high-modulus Grade "T" elastomer.</p>
--	---	--

## Gasket Grade Index

STANDARD GASKETS*				
Grade	Temperature Range	Compound	Color Code	General Service Application
<b>EP</b>	-40°F to +250°F (-40°C to 110°C)	EPDM	Red/ Green	Water, dilute acids, alkalis, salts, and many chemical services not involving hydrocarbons, oils, or gases. Excellent oxidation resistance. <b>NOT FOR USE WITH HYDROCARBONS</b>
<b>T</b>	-20°F to +180°F (-29°C to 82°C)	Nitrile (Buna-N)	Orange	Petroleum products, vegetable oils, mineral oils, and air contaminated with petroleum oils. <b>NOT FOR USE IN HOT WATER SERVICES</b>
STANDARD GASKETS FOR PETROLEUM PRODUCTS*				
Grade	Temperature Range	Compound	Color Code	General Service Application
<b>O</b>	+20°F to +300°F (-20°C to 149°C)	Fluoro Elastomer	Blue	High temperature resistance to oxidizing acids, petroleum oils, hydraulic fluids, halogenated, hydrocarbons and lubricants

\*NOTE: Other gasket compounds and details available on request.

## Gasket Recommendation Listing

PETROLEUM PRODUCTS			
Service	Gasket Grade	Service	Gasket Grade
Crude Oil - Sour	T	JP-6, 100°F (38°C) Maximum Temp.	O
Diesel Oil	T	Kerosene	T
Fuel Oil	T	Lube Oil, to 150°F (66°C)	T
Gasoline, Leaded	T	Motor Oil	T
Gasoline, Unleaded*	(O)	Tar and Tar Oil	T
Hydraulic Oil	T	Transmission Fluid –Type A	O
JP-3, JP-4 and JP-5	T/O	Turbo Oil #15 Diester Lubricant	O

Where more than one gasket grade is shown the preferred gasket grade is listed first. Where the gasket grade is shown in parentheses, Contact an Anvil Representative for an engineering evaluation and recommendation. Specify gasket grade when ordering. Use Gruvlok lubricant on gasket. Check gasket color code to be certain it is recommended for the service intended.

Unless otherwise noted, all gasket listings are based upon 100°F (38°C) maximum temperature service conditions. For services not listed, contact an Anvil Representative for recommendations. \*Contact an Anvil Rep. for service evaluation.



# Oilfield Couplings



## Carbon Steel Merchant Couplings

Sizes 1/8" – 6"

Manufactured in accordance with ASTM specification A865. Merchant couplings in sizes 1/8" through 2" are normally supplied straight tapped. Sizes 2 1/8" and larger are taper tapped. Taper tapped standard merchant couplings in sizes 1/8" through 2" are available upon request. API line pipe couplings are used in all sizes over 6". Couplings from 1/8" through 2" are dipped in rust preventative. Couplings 2 1/8" and larger are phosphated. Galvanized full couplings are also available.

## JB Smith Sub & Combination Couplings

J.B. Smith's full range of Sub-Tubing and Combination Couplings are available in regular, EUE, and round, sharp and combination threads.

Sizes 2" regular through 4" EUE

Material J-55 and N-80

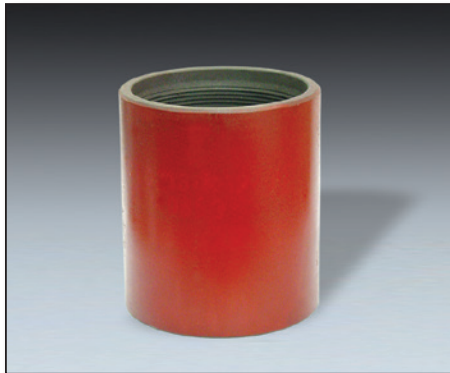

## API Line Pipe Couplings

Sizes 1/8" – 12"

These couplings are manufactured in accordance with American Petroleum Institute Specification 5L. All sizes are taper tapped 3/4" per foot on the diameter.

Line pipe couplings in sizes 1/8" – 1 1/2" are dipped in rust preventative. Couplings in sizes 2" and larger are phosphated.



# Forged Steel Fittings and Nipples

## Steel Pipe Nipples

Anvil nipples are manufactured in accordance with ASTM Specifications A733 – Welded and seamless carbon steel nipples (A53 C/W and 106 SMLS). Where possible, each nipple is identified with Anvil Trademark, Seamless or Welded indication, Pipe Schedule and Material designation. Anvil can supply special nipples pertaining to lengths, threading and finishes. Cold service nipples available upon request.





## Forged Steel Fittings

Steel Pipe Fittings add an important dimension to the industry-leading line of flow control products already offered by Anvil. Anvil is a respected name and its products are well-regarded for high quality and consistency.

### Materials:

The Anvil Forged Carbon Steel Fittings consist of forgings, bars, seamless pipe or tubes which conform to the requirements for melting process, chemical composition and mechanical properties of ASTM A105.

### Design Basis:

ASME B16.11 – Forged fittings, socket welding and threaded.

### Dimensions:

ASME B16.11, unless otherwise noted. All catalog dimensions are in inches.

### Threads:

ASME 1.20.1

## IPC COATINGS

### Scotchkote 134

A fusion bonded epoxy coating designed for internal corrosion protection of metal. Coating is resistant to hydrocarbons, acids, brines, saltwater, harsh chemicals, wastewater and other corrosive media. Also can be used in potable water services

### Corvel 1660

A fusion bonded two part epoxy coating designed for internal corrosion protection of metal. Coating is resistant to H<sub>2</sub>S, CO<sub>2</sub>, acids, harsh chemicals, brines, saltwater and other corrosive media found in the oil and gas industry.

Typical applications for the above coatings include: Production facilities where H<sub>2</sub>S is present, water floods & CO<sub>2</sub> floods, injection wells, tank battery hookups, header systems, well head hookups, etc...

In stock coated product list available on the Anvil website [www.anvilintl.com](http://www.anvilintl.com). All Anvil manufactured products available for coating as well as additional coatings available upon request.

For additional information regarding IPC (Internally Plastic Coated) products please contact an Anvil representative."



## Pumping Tee

The Anvil Pumping Tee is specifically designed to withstand the rugged demands of the Oilfield Industry. The Pumping Tee is made in the U.S.A. – 100% domestic. It is available in Bare and IPC. Other coatings are available upon request.

### Material Options:

3000# Ductile Iron per ASTM A395 Gr. 60-40-18

### Finish Options:

Rust inhibiting Paint: RED (Standard)

Scotchkote 134

Corvel 1660

Teflon available

Anvil's large and complete line of pipe hangers is based on over a century of experience in the industrial piping field. Anvil furnishes hangers and supports for a wide range of industrial markets, including Power, Petrochemical, Refinery, and Pulp and Paper.

Anvil's domestic manufactured pipe support product offerings include Pipe Clamps, Clevises, Structural and Concrete Attachments, Brackets, Pipe Saddles and Rollers, Slides and Anchors, and Pipe Alignment Guides. Anvil also offers capabilities in providing Special Fabrication and miscellaneous Structural Steel Fabrication.



### Anvil Figure 264 Pipe Stanchion

Stanchion-type support where vertical adjustment of steel pipe is required.

**FEATURES:**

- Vertical adjustment of approximately 4½ inches.
- Saddle supports a broad range of pipe sizes.

### Anvil Figure 259 Pipe Stanchion Saddle

Cast iron stanchion saddle with steel yoke and nuts. Size range: 4 through 36 inch pipe.

**FEATURES:**

- U-bolt yoke provides stability



### Anvil Figure 295 Double Bolt Pipe Clamp

Recommended for suspension of pipe requiring insulation and where flexibility of the clamp is desirable. Size range: ¾ through 36 inch.

**FEATURES:**

- Accommodates up to 4" thick insulation.
- Load ratings meet ASME code requirements and are substantiated by laboratory test.

## Strut and Strut Fittings Continuous Metal Framing

Anvil-Strut offers a complete line of continuous slot metal framing complete with channels, fittings and accessories for any framing or support problem...large or small, heavy or light.

Anvil-Strut's offering comes complete with exacting standards of research, design, engineering and manufacturing. Maximum recommended load ratings for channels have been established through testing and are based on allowable stresses applicable to strut material specifications.

Beyond the versatility that strut and strut fittings offer as a basic building material, metal framing is popular for other applications such as electric boxes, sign posts, meter run and offshore catwalks.

## The Anvil-Strut Connection, Easy as 1 – 2 – 3 ...

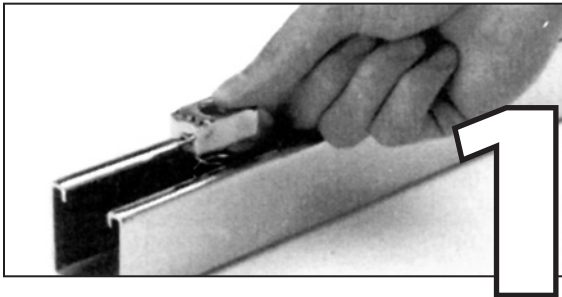

Insert the clamping nut anywhere along the continuous slot channel. A 90° clockwise turn positions the grooves and teeth in the nut with the inturned edges of the channel

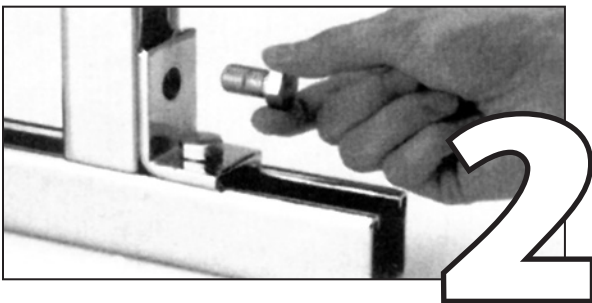

The strut fitting provides the connection of channels

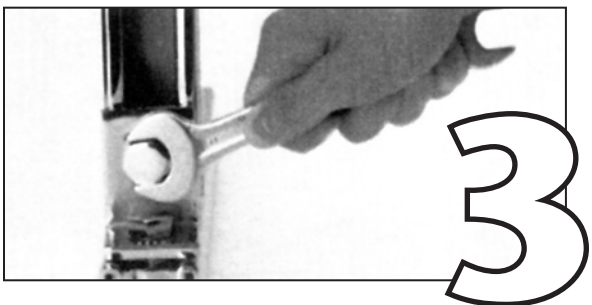

Tighten the bolt(s) to secure the connection

## Standard Channel and Fitting Assembly

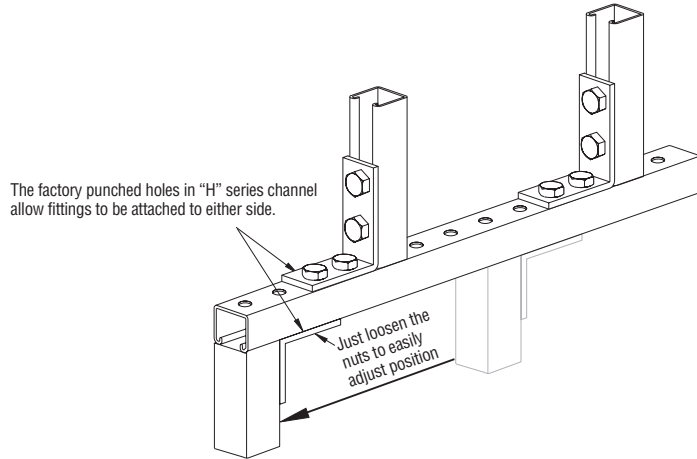

## Floor Mounted Stand

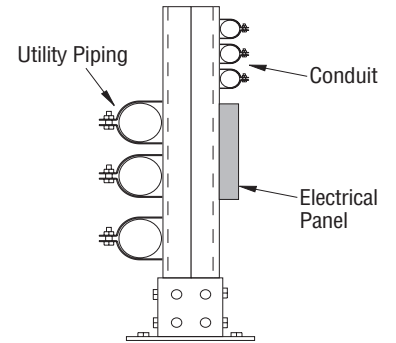

Island stands allow you to mount equipment or piping on both sides in trenches and in service isles.

## Electric Panel Supports

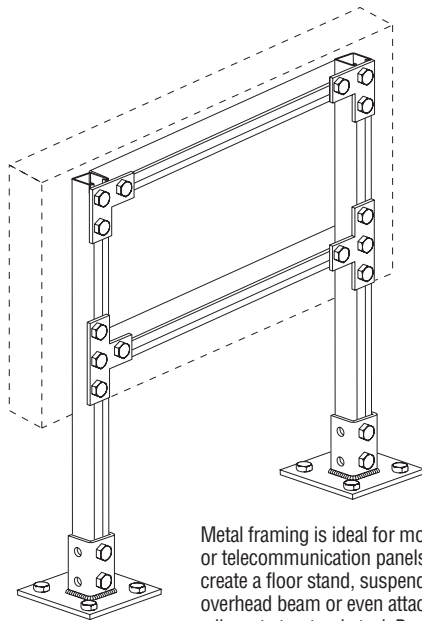

Metal framing is ideal for mounting electrical or telecommunication panels. It allows you to create a floor stand, suspend panels from an overhead beam or even attach panels to adjacent structural steel. Bracing may be added for heavier load requirements.

## Ganged Pipe Support

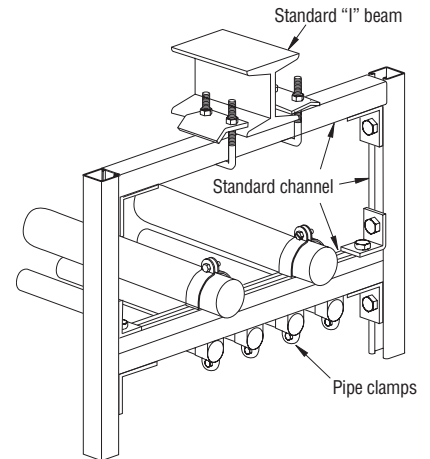



# H-Block Supports

Anvil's new H-Block Supports will provide a full complement of products to support gas and refrigeration piping, plumbing, multiple lines, electrical conduit, ductwork, HVAC and many other applications. H-Block supports are pre-assembled and are suitable for installation in the oilfield and other flat surfaces.



Base Area Shown = 33.1 Sq. In.  
For use in bearing calculations

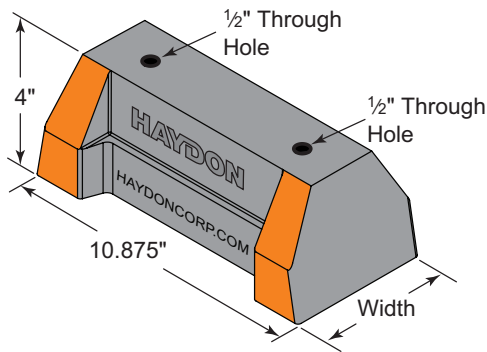

## Finish Options

The channel for H-Block support assemblies includes a variety of options. The strut can be made in special lengths, finishes, and alloys including Aluminum, Stainless Steel both 304 & 316, PVC coated, Powder coated, Zinc Trivalent Chromium, Pre-Galvanized and Hot Dipped Galvanized.

## Product Features

- 100% Recycled Rubber
- LEED Certifiable
- Independent Laboratory Tested
- Resistance to Freeze and Thaw
- Light Weight Base
- No Deterioration
- Orange Safety Stripe for Maximum Visibility
- Stable Base with Holes to Secure
- Dampens Vibrations, Limits Movement
- Roller Series Offers Added Support for Pipe Installation

## Oilfield Applications

- Tank Battery Hook-up Systems
- Header Systems
- Off Shore Catwalks
- Meter Run
- Pipe & Conduit Supports
- Sign Posts
- Electric Box Support

## HBS-Base Series

Model No.	Height	Width	Base Length	Weight	Uniform Load Capacity (Lbs) *
HBS-Standard-Base Only	4" (101mm)	5" (127mm)	10-7/8" (276mm)	4.80 lbs.	2,500 *

\* This load is only for the capacity of the components in this assembly. Please consult roofing manufacturer or engineer for roof load capacity

## Model No. HBS Roller Series



HBS-Base with 15/8" H-132 Pre-Galv. Steel Channel and Rollers



From concepting to finalizing, Anvil's unique design services group provides complete three-dimensional drawings for threaded, grooved systems applications.

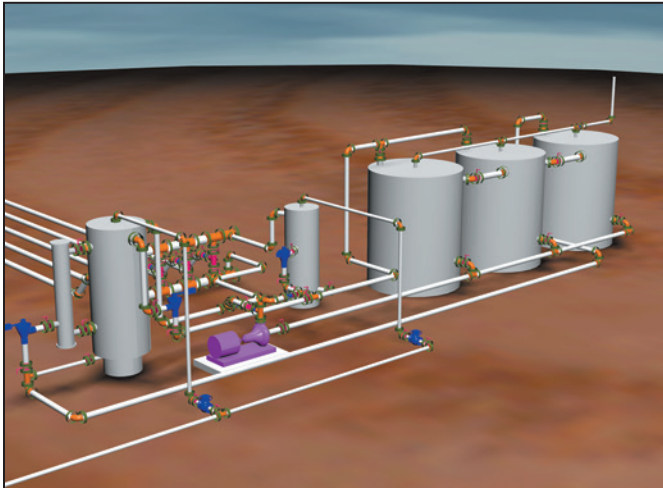

### Features, Advantages, Benefits

- Standardized facility construction
- Accurate battery take-offs
- Representation on your location
- Faster retrofit turnarounds

### Applications

#### ONSHORE PRODUCTION FACILITIES

- Tank batteries
- Water floods
- CO2 floods
- Header systems
- Gas processing

#### OFFSHORE RIGS AND PLATFORMS

- Design layout for grooved piping
- Drain systems
- Fuel lines
- Bulk storage and delivery systems
- Air systems

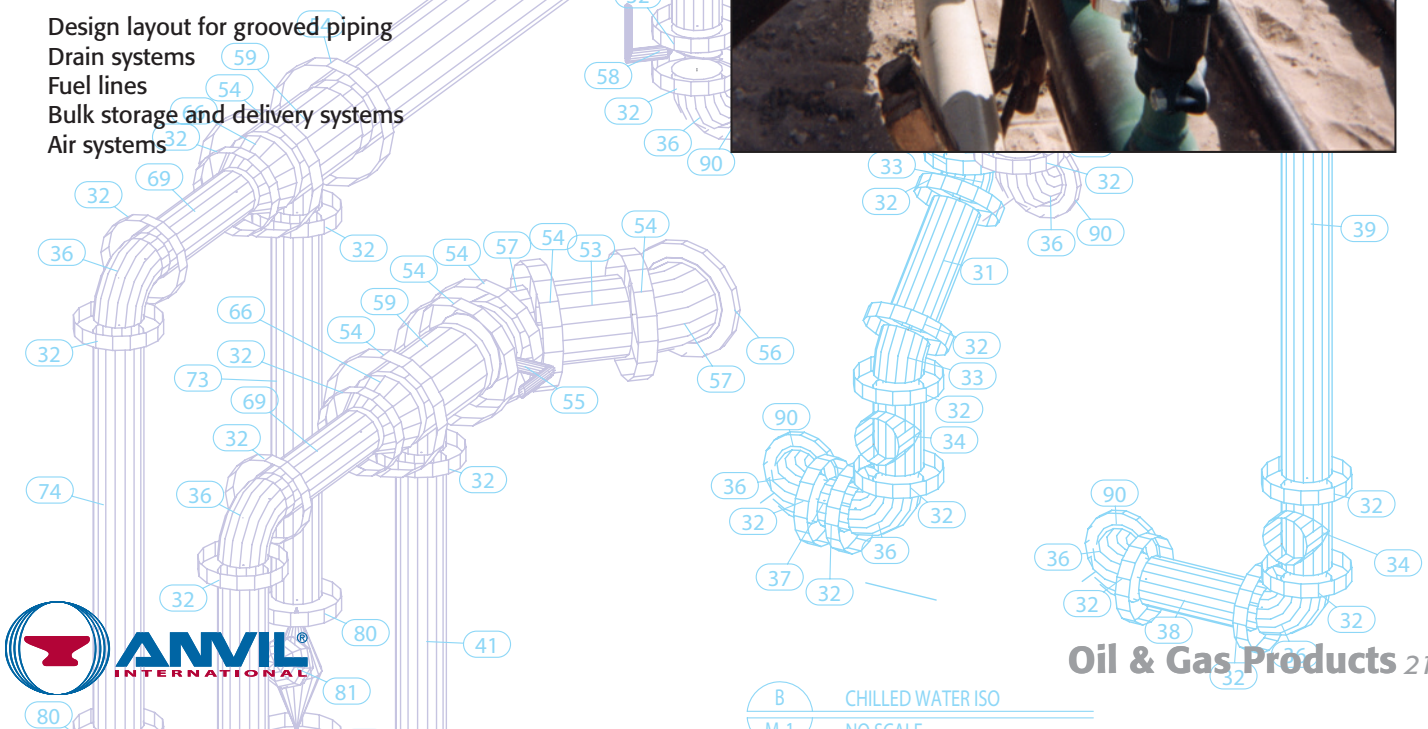

1. **CONTROLLING PROVISIONS:** These terms and conditions shall control with respect to any purchase order or sale of Seller's products. No waiver, alteration or modification of these terms and conditions whether on Buyer's purchase order or otherwise shall be valid unless the waiver, alteration or modification is specifically accepted in writing and signed by an authorized representative of Seller.
2. **DELIVERY:** Seller will make every effort to complete delivery of products as indicated on Seller's acceptance of an order, but Seller assumes no responsibility or liability, and will accept no back charge, for loss or damage due to delay or inability to deliver caused by acts of God, war, labor difficulties, accident, delays of carriers, by contractors or suppliers, inability to obtain materials, shortages of fuel and energy, or any other causes of any kind whatsoever beyond the control of Seller. Seller may terminate any contract of sale of its products without liability of any nature, by written notice to Buyer, in the event that the delay in delivery or performance resulting from any of the aforesaid causes shall continue for a period of sixty (60) days. Under no circumstances shall Seller be liable for any special or consequential damages or for loss, damage, or expense (whether or not based on negligence) directly or indirectly arising from delays or failure to give notice of delay.
3. **WARRANTY:** Seller warrants for one year from the date of shipment Seller's manufactured products to the extent that Seller will replace those having defects in materials or workmanship when used for the purpose and in the manner which Seller recommends. If Seller's examination shall disclose to its satisfaction that the products are defective, and an adjustment is required, the amount of such adjustment shall not exceed the net sales price of the defective products only and no allowance will be made for labor or expense of repairing or replacing defective products or workmanship or damage resulting from the same. Seller warrants the products which it sells of other manufacturers to the extent of the warranties of their respective makers. Where engineering design or fabrication work is supplied, Buyer's acceptance of Seller's design or of delivery of work shall relieve Seller of all further obligation, other than as expressed in Seller's product **THIS IS SELLER'S SOLE WARRANTY. SELLER MAKES NO OTHER WARRANTY OF ANY KIND, EXPRESSED OR IMPLIED AND ALL IMPLIED WARRANTIES OF MERCHANTABILITY AND FITNESS FOR A PARTICULAR PURPOSE WHICH EXCEED SELLER'S AFORESTATED OBLIGATION ARE HEREBY DISCLAIMED BY SELLER AND EXCLUDED FROM THIS WARRANTY.** Seller neither assumes, nor authorizes any person to assume for it, any other obligation in connection with the sale of its engineering designs or products. This warranty shall not apply to any products or parts of products which (a) have been repaired or altered outside of Seller's factory, in any manner; or (b) have been subjected to misuse, negligence or accidents; (c) have been used in a manner contrary to Seller's instructions or recommendations. Seller shall not be responsible for design errors due to inaccurate or incomplete information supplied by Buyer or its representatives.
4. **SELLER'S LIABILITY:** Seller will not be liable for any loss, damage, cost of repairs, incidental or consequential damages of any kind, whether based upon warranty (except for the obligation accepted by Seller under "Warranty" above), contract or negligence arising in connection with the design, manufacture, sale, use or repair of the products or of the engineering designs supplied to Buyer.
5. **RETURNS:** Seller cannot accept return of any products unless its written permission has been first obtained, in which case same will be credited subject to the following: (a) All material returned must, on its arrival at Seller's plant, be found to be in first-class condition; if not, cost of putting in saleable condition will be deducted from credit memoranda; (b) A handling charge deduction of twenty percent (20%) will be made from all credit memoranda issued for material returned; (c) Transportation charges, if not prepaid, will be deducted from credit memoranda.
6. **SHIPMENTS:** All products sent out will be carefully examined, counted and packed. The cost of any special packing or special handling caused by Buyer's requirements or requests shall be added to the amount of the order. No claim for shortages will be allowed unless made in writing within ten (10) days for products damaged or lost in transit should be made on the carrier, as Seller's responsibility ceases, and title passes, on delivery to the carrier.
7. **SPECIAL PRODUCTS:** Orders covering special or non-standard products are not subject to cancellation except on such terms as Seller may specify on application.
8. **PRICES AND DESIGNS:** Prices and designs are subject to change without notice. All prices are F. O. B. Point of Shipment, unless otherwise stated.
9. **TAXES:** The amount of any sales, excise or other taxes, if any, applicable to the products covered by this order, shall be added to the purchase price and shall be paid by Buyer unless Buyer provides Seller with an exemption certificate acceptable to the taxing authorities.
10. **NUCLEAR PLANTS:** Where the products, engineering design or fabrication is for nuclear plant applications, Buyer agrees: (a) to take all necessary steps to add Seller as an insured under the American Nuclear Insurers' (ANI)-pool and under the Mutual Atomic Energy Reinsurance Pool (MAERP) for property damage and liability insurance and if necessary steps could have been taken, but are not taken, Buyer shall hold Seller harmless against all such losses which could have been thus covered, (b) to hold Seller harmless with respect to any personal injury (or death), property damage or other loss in a nuclear incident which is caused directly or indirectly by defective design, material, or workmanship furnished by Seller and which is covered by insurance maintained by Buyer (or which could be so covered but with respect to which Buyer has elected to self-insure), and further agrees to waive subrogation by its carriers of such insurance against Seller, and (c) as to nuclear hazards for which Buyer cannot obtain insurance coverage, the liability of Seller for any personal injury (or death), property damage or other loss directly caused by defective design, material, or workmanship furnished by Seller shall not exceed the value of the material furnished by Seller at the time of the loss occurrence.
11. **MINIMUM INVOICE:** \$25.00 plus transportation.
12. **TERMS:** Cash, net 30 days unless otherwise specified.

# BRANDS OF ANVIL INTERNATIONAL



Anvil product lines include malleable and cast iron fittings, unions and flanges; seamless and welded steel pipe nipples; steel pipe couplings; universal anvilets; forged steel fittings and unions; pipe hangers and supports; threaded rod; and engineered hangers.



The Gruvlok product line consists of couplings for grooved and plain-end fittings, butterfly valves and check valves; flanges; pump protection components; pipe grooving tools; as well as copper and stainless steel system components.



The SPF/Anvil product line includes a variety of internationally sourced products such as grooved couplings, fittings, cast iron, malleable iron and ductile iron threaded fittings, steel pipe nipples, as well as tee-lets.



Catawissa NACE and API approved wing unions for Standard Service are offered in non-pressure seal ends as well as threaded and butt weld, and are interchangeable with most leading union manufacturers. Fully traceable and available with complete mill certifications, Catawissa's oilfield wing union product line includes the standard ball-and-cone design plus our unique Figure 300 Flat Face design, where space and pipe line separation are a consideration.



Anvil EPS-Engineered Pipe Supports are products used to support piping systems under thermal, seismic, and other dynamic loading conditions. The product line encompasses variable spring hangers, constant supports, sway struts and snubbers as well as standard and special design clamps. Anvil EPS brings the highest quality products and innovative engineering solutions to common and uncommon piping system problems.



JB Smith is the leading manufacturer of oil country tubular fittings, swages and bull plugs – all meeting API specifications. Offering tubing nipples, casing nipples as well as a full line of traditional line pipe and oil country threads in every schedule, JB Smith is the resource for all your oilfield needs.



The Merit product line includes a variety of tee-lets and drop nipples for fire protection applications. Most Merit products are UL/ULC Listed, FM Approved, and rated from 175 to 300 psi.



Steel pipe nipples and steel pipe couplings are manufactured in accordance with the ASTM A733 Standard Specification for Welded and Seamless Carbon Steel and Stainless Steel Pipe Nipples. Steel pipe couplings are manufactured in accordance with the ASTM A865 Standard Specification for Threaded Couplings, Steel, Black or Zinc-Coated (Galvanized) Welded or Seamless, for Use in Steel Pipe Joints. API couplings are manufactured in accordance with the API Specification for line pipe.



Anvil-Strut products include a complete line of channel in stock lengths of 10 and 20 feet, with custom lengths available upon request. A variety of fittings and accessories are also offered. All products can be ordered in an assortment of finishes and material choices including SupR-Green™, Zinc Trivalent Chromium, pre-galvanized, hot-dipped galvanized, electro-galvanized, aluminum, plain, and stainless steel.



Founded in 1983, NAP is a manufacturer of fabrication equipment, including automatic welders, plasma cut-off equipment, hole cutting equipment, make-on machines and pipe threaders. NAP, innovators of pipe fabrication equipment.

### **About ASC Engineered Solutions**

ASC Engineered Solutions is defined by quality—in its products, services and support. With more than 1,400 employees, the company’s portfolio of precision-engineered piping support, valves and connections provides products to more than 4,000 customers across industries, such as mechanical, industrial, fire protection, oil and gas, and commercial and residential construction. Its portfolio of leading brands includes ABZ Valve®, AFCON®, Anvil®, Anvil EPS, Anvil Services, Basic-PSA, Beck®, Catawissa, Cooplet®, FlexHead®, FPPI®, Gruvlok®, J.B. Smith, Merit®, North Alabama Pipe, Quadrant®, SCI®, Sharpe®, SlideLOK®, SPF® and SprinkFLEX®. With headquarters in Commerce, CA, and Exeter, NH, ASC also has ISO 9001:2015 certified production facilities in PA, TN, IL, TX, AL, LA, KS, and RI.



[asc-es.com](http://asc-es.com)

Building connections that last™

