

Building connections that last™



# Pipe Hanger Design & Engineering

January 2024

For the most current product/ pricing information on ASC Engineered Solutions, please visit our website at [asc-es.com](http://asc-es.com).

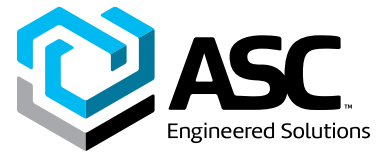




[asc-es.com](http://asc-es.com)

Building connections that last™

---



# Anvil and Smith–Cooper are now ASC Engineered Solutions™

In 2019, Anvil International merged with Smith–Cooper International. The result was a complementary pair of industry leaders working side by side to provide precision-engineered pipes, valves, fittings and supports, along with related services.

For over 150 years, we have worked to build a strong, vibrant tradition of making connections – pipe to pipe and people to people. We've always been dedicated to building connections that last. As ASC Engineered Solutions, we are ready to make those connections stronger than ever by focusing as much on how we serve our customers as on the products we provide. This is what makes ASC stand out.

We're in the solutions business. That means we go beyond a product portfolio of unmatched quality and breadth. A solution involved much more than products: it takes expertise, reliable availability and dependable partnership. Providing engineered solutions means solving customer challenges – and that's why we exist.

**One company.**

**One focus.**

**Your success.**



## Piping and Pipe Hanger Design and Engineering

### Weights of Piping Materials

The material in this booklet has been compiled to furnish pipe hanger engineers with the necessary data and procedures to determine pipe hanger loads and thermal movements of the pipe at each hanger location.

The tabulation of weights has been arranged for convenient selection of data that formerly consumed considerable time to develop. In many instances this information was not available for general distribution. This made it necessary to develop average or approximate weights that may be substituted with actual weights whenever practical.

### Load Calculation Problem

The "Hanger Load Calculation Problem" is typical of the actual steps required in the solution of any pipe hanger installation.

Great care was taken in collecting and printing data in this booklet to assure accuracy throughout. However, no representation or warranty of accuracy of the contents of this booklet is made by Anvil. The only warranties made by Anvil are those contained in sales contracts for design services or products.

## TABLE OF CONTENTS

Page Design of Pipe Hangers .....	5
Determination of Hanger Locations .....	7
Hanger Load Calculations .....	7
Thermal Movement Calculations .....	12
Selection of the Proper Hangers .....	14
Typical Pipe Support Specification .....	22
Nuclear Pipe Hangers .....	25
Seismic Supports .....	25
Supports for Grooved Piping .....	28
Application Examples .....	31
Weights of Piping Materials .....	38
Charts and Tables .....	64



asc-es.com

Building connections that last™

## Introduction

To avoid confusion, it is necessary to define the terms pipe hanger and pipe support and clarify the difference between the two.

Pipe hangers are generally considered to be those metal elements which carry the weight from above with the supporting members being mainly in tension. Pipe supports are considered to be those elements which carry the weight from below with the supporting members being mainly in compression.

It has become widely recognized that the selection and design of pipe hangers is an important part of the engineering study of any modern steam generating or process installation. Problems of pipe design for high temperature, high pressure installations have become critical to a point where it is imperative that such aspects of design as the effect of concentrated hanger loads on building structure, pipe weight loads on equipment connections, and physical clearances of the hanger components with piping and structure be taken into account at the early design stages of a project.

Engineers specializing in the design of pipe hangers have established efficient methods of performing the work required to arrive at appropriate hanger designs. However, the engineer who devotes varying portions of his time to the design of pipe hangers often must gather a considerable amount of reference data peculiar only to the hanger calculations for his current project.

It is the purpose of this article to present a compilation of all information necessary for the design of hangers, including a technical section devoted to the listing of piping material, weights, and thermal expansion data. Also, the discussions of the various steps involved in designing supports, presented here in their proper sequence, should serve as a good reference source for the engineer who only occasionally becomes involved in the essentials of hanger design.

The first of these steps is that of determining and obtaining the necessary amount of basic information before proceeding with calculations and detailing of the pipe supports. No design is complete unless the engineer has had the opportunity to review the equivalent of the following project data:

- The pipe hanger specification, when available (A typical hanger specification is shown on pages 22 and 23).
- A complete set of piping drawings.
- A complete set of steel and structural drawings including equipment foundation and boiler structure details.
- A complete set of drawings showing the location of ventilating ducts, electrical trays, pumps, tanks, etc.
- The appropriate piping specifications and data, which will include pipe sizes and composition identification, wall thicknesses, and operating temperatures.
- A copy of the insulation specifications with densities.
- Valve and special fittings lists, which will indicate weights.
- The movements of all critical equipment connections such as boiler headers, steam drums, turbine connections, etc.
- The results of the stress, flexibility and movement calculation performed for critical systems such as Main Steam, High Temperature Reheat, etc.

The steps in which the engineer applies this information are:

- 1 Determine hanger locations.
- 2 Calculate hanger loads.
- 3 Determine thermal movement of the piping at each hanger location.
- 4 Select hanger types: spring assembly, either constant support, variable spring type, rigid assembly, etc.
- 5 Check clearance between the hanger components and nearby piping, electrical cable trays, conduits, ventilating ducts, and equipment.

The final step will not be discussed to any great degree. This aspect of design is governed solely by the requirements and layouts of the individual job. Instead, attention will be devoted to steps 1 to 4, where the scope of good hanger practice can be generally defined for any installation.

Recognizing that each new piping design presents many new challenges to the engineer, no attempt is made to state fixed rules and limits applicable to every hanger design. Rather, the intention is to illustrate ideas which will serve as a guide to a simple, practical solution to any pipe support problem.

## Integral Attachments

Integral attachments are fabricated so that the attachment is an integral part of the piping component. Examples of integral attachments include ears, shoes, lugs, cylindrical attachments, rings and skirts. Integral attachments are used in conjunction with restraints or braces where multi-axial restraint in a single member is required. Of particular importance is the localized stresses induced into the piping or piping component by the integral attachments. Several methods to determine the local stresses are available including relatively simple hand/ cookbook calculations provided in Welding Research Council (WRC) Bulletins 107, 198, and 297, ASME Code Cases N-318 and N-392, or through a detailed finite element analysis. Section 121 of ASME B31.1 discusses additional considerations for integral attachments.

## Hanger Spans

Support locations are dependent on pipe size, piping configuration, the location of heavy valves and fittings, and the structure that is available for the support of the piping.

No firm rules or limits exist which will positively fix the location of each support on a piping system. Instead, the engineer must exercise his own judgement in each case to determine the appropriate hanger location.

The suggested maximum spans between hangers listed in table below reflect the practical considerations involved in determining support spacings on straight runs of standard wall pipe. They are normally used for the support spacings of critical systems.

Span Between Reports

Nom. Pipe Size (In.)	1	1½	2	2½	3	3½	4	5	6	8	10	12	14	16	18	20	24	30
Span Water (Ft.)	7	9	10	11	12	13	14	16	17	19	22	23	25	27	28	30	32	33
Steam, Gas, Air (Ft.)	9	12	13	14	15	16	17	19	21	24	26	30	32	35	37	39	42	44



# The Design of Pipe Hangers

The spans in table are in accordance with MSS Standard Practice SP-69. They do not apply where concentrated weights such as valves or heavy fittings or where changes in direction of the piping system occur between hangers.

For concentrated loads, supports should be placed as close as possible to the load in order to minimize bending stresses.

Where changes in direction of the piping of any critical system occur between hangers, it is considered good practice to keep the total length of pipe between the supports less than  $\frac{3}{4}$  the full spans in table below.

When practical, a hanger should be located immediately adjacent to any change in direction of the piping.

## Sample Problem

In the sample problem (Figure 1) seven supports are shown on the 12 inch line, and two on the 6 inch pipe.

Note that the hanger H-1 has been placed adjacent to the valve weight concentration. The proximity of the hanger to the valve is helpful in keeping the load at terminal connection A to a minimum. Also, the bending stresses induced in the pipe by the valve weight are kept to a minimum.

The selection of the location for hanger H-2 entails a change in direction of the pipe between two hangers. In order to avoid excessive overhang of the pipe between hangers H-1 and H-2, the length of pipe between these hangers is made less than three fourths the suggested maximum span shown in the table on the previous page.

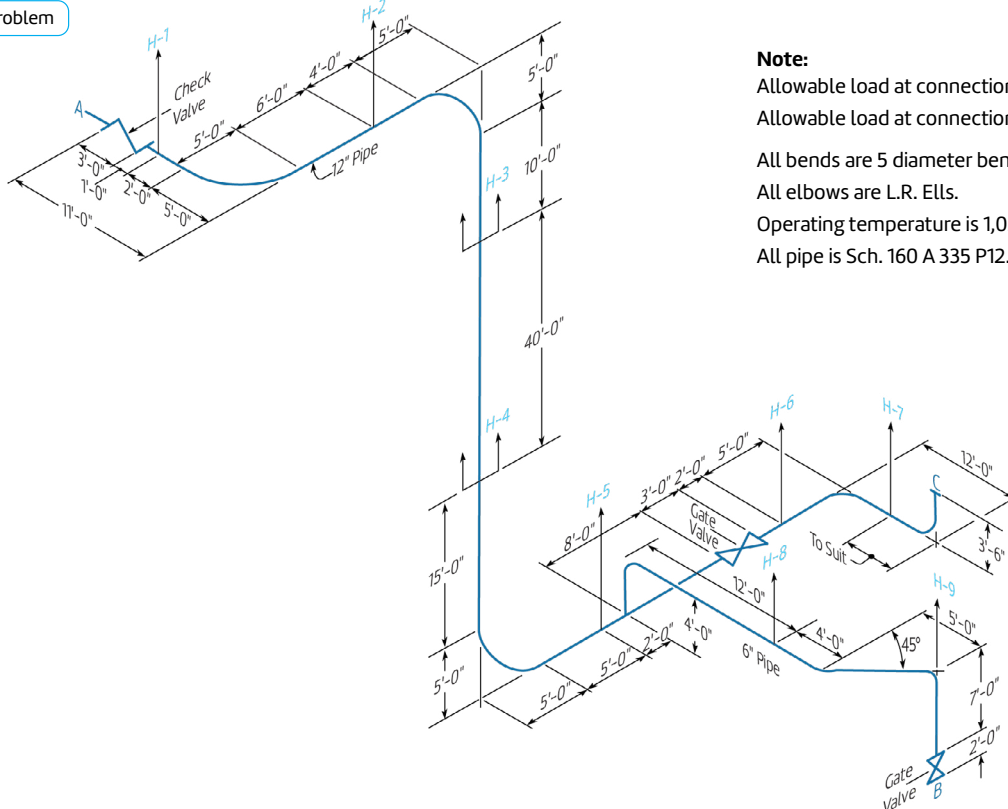
In considering the vertical section of the pipe on which H-3 and H-4 are shown, it should first be noted that this section of the pipe could be supported by one hanger rather than two as indicated. Two hangers will certainly provide greater stability than will a single hanger. Another deciding factor as to whether one hanger or a multiple hangers should be used is the strength of the supporting steel members of the structure. The use of two hangers will permit the total riser weight to be proportioned to two elevations of the structure, avoiding the concentration of all the riser load at one building elevation.

The locations for hangers H-5 and H-6 are governed by the suggested maximum span as well as the position of the concentrated valve weight. Consequently, H-6 has been located adjacent to the valve, and H-5 at a convenient location between the valve and the 12 inch riser.

The location of hanger H-7 will be determined by calculation to satisfy the condition that no pipe load is to be applied to terminal connection C. It is obvious that by moving the hanger along the 12 foot section of pipe, the amount of load on connection C will vary. One support location exists where the entire section will be "balanced", and the load at C equal to zero.

The calculations to determine the exact location of H-7 are shown in the section entitled "Hanger Load Calculation".

FIGURE 1 – Sample Problem



### Note:

Allowable load at connection A is 500 lbs.  
Allowable load at connection B and C is zero.

All bends are 5 diameter bends.  
All elbows are L.R. Ells.  
Operating temperature is 1,050°F.  
All pipe is Sch. 160 A 335 P12.

# Hanger Load Calculations

Consider next the 6 inch section of pipe on which H-8 and H-9 are shown. One of the requirements for this hanger problem is that the load at terminal connection B shall be zero. By placing H-9 directly over connection B, we can easily assure that this load will be zero. Also, this hanger location eliminates any bending stresses in the pipe that would be caused by the weight of the valve and vertical pipe at point B. If H-9 could not be located at this point due to structural limitations, it would be desirable to place it as close as possible to the vertical section of pipe to keep the cantilever effect to a minimum.

Hanger H-8 is located at a convenient distance between H-9 and the intersection of the 6 inch and 12 inch pipes. In this instance, the location of adequate building structure will determine the hanger position.

The methods involved in locating hangers for this problem are typical of those employed by the hanger engineer in the design of pipe supports. Although the individual piping configurations and structure layout will vary in practically every instance, the general methods outlined above will apply for any critical piping system.

## Hanger Load Calculations

The thermal expansion of piping in modern high pressure and temperature installations makes it necessary for the designer to specify flexible supports, thereby requiring considerable thought to the calculation of hanger loads.

Turbine and boiler manufacturers are especially concerned about the pipe weight on their equipment and often specify that the loads at pipe connections shall be zero. The hanger designer must be certain that the loads on the equipment connections of a piping system do not exceed the limits specified by the equipment manufacturers.

The majority of supports for a high temperature system are of the spring type. The designer must work to a high degree of accuracy in determining the supporting force required at each hanger location to assure balanced support, in order to select the appropriate size and type of spring support.

We have prepared a sample problem (Figure 1), in which all of the hangers except H-7 have been located. This illustration is limited to as few pipe sections as possible, but incorporates most of the problems encountered in hanger load calculations.

The calculation of loads for hangers involves dividing the system into convenient sections and isolating each section for study. A free body diagram of each section should be drawn to facilitate the calculations for each hanger load. Most of the free body diagrams presented here include as large a section of the piping system as is practical for a simple arithmetical solution to the problem.

The following solution is not intended to illustrate the only acceptable solution. Rather, it shows a composite of various accepted methods which, for the problem under consideration, produce a well balanced system. Of the approaches that could be made to the solution of any problem, there will be one method that will produce the best balanced system. Although the individual loads may vary, the total of all hanger loads would be the same in every case.

The first step in the solution of a hanger load problem is to prepare a table of weights. The table for our sample problem (Figure 1) is:

Table of Weights – Sample Problem – (Figure 1)

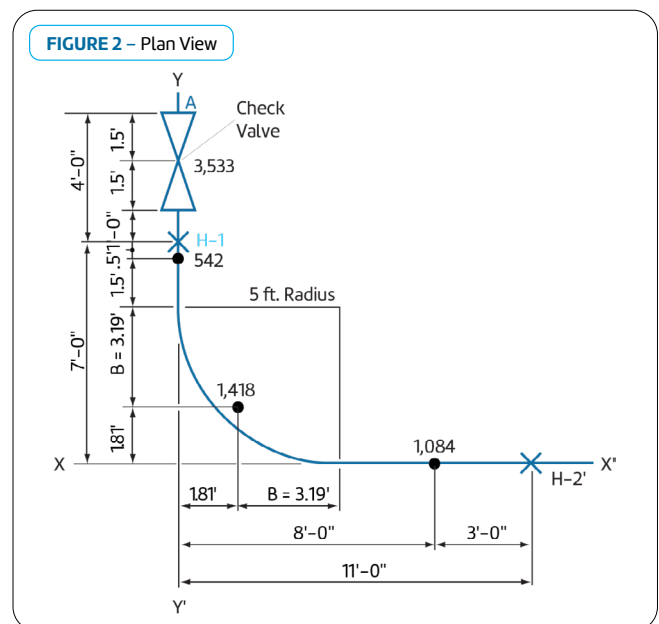
Description	Weight	Insulation Weight (Ca-Si)	Total Weight	Weight Used In Calc.
12" Sch. 160 Pipe	160.3 lb./ft.	20.4 lb./ft.	180.7 lb./ft.	180.7 lb./ft.
12" Sch. 160 L.R. Elbow	375 lb.	61.2 lb.	436.2 lb.	436 lb.
12" 1500 lb. Check Valve	3370 lb.	163.2 lb.	3533.2 lb.	3533 lb.
12" 1500 lb. Gate Valve	4650 lb.	163.2 lb.	4813.2 lb.	4813 lb.
12" 1500 lb. W.N. Flange	843 lb.	30.6 lb.	873.6 lb.	874 lb.
12" 5 Dia. Bend	1258 lb.	160.2 lb.	1418.2 lb.	1418 lb.
6" Sch. 160 Pipe	45.3 lb./ft.	11.5 lb./ft.	56.8 lb./ft.	56.8 lb./ft.
6" Sch. 160 90° L.R. Elbow	53 lb.	17.2 lb.	70.2 lb.	70 lb.
6" Sch. 160 45° Elbow	26 lb.	6.9 lb.	32.9 lb.	33 lb.
6" 1500 lb. Gate Valve	1595 lb.	80.5 lb.	1675.5 lb.	1676 lb.

Draw a free body diagram of the piping between point A and H-2, showing all supporting forces and all valve and pipe weights (Figure 2). We will consider the loads and supporting forces between A, H-1 and H-2 acting about the axes x-x' and y-y', and apply the three equations:

$$\sum M_{x-x'} = 0$$

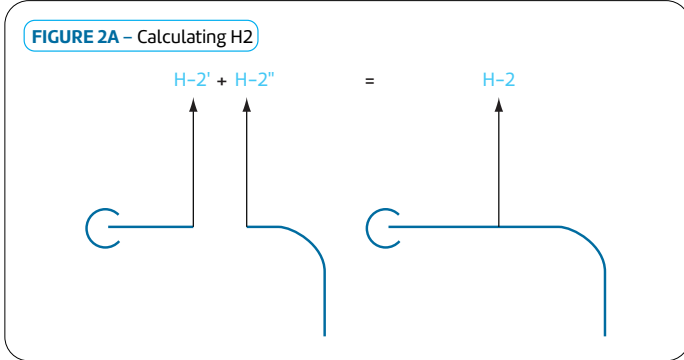
$$\sum M_{y-y'} = 0$$

$$\sum V = 0.$$



# Hanger Load Calculations

Note that the value for  $H-2$  on this section of the piping system represents only a part of the total hanger force at  $H-2$ . For clarity, we have labeled this force  $H-2'$ . In the calculations for the next section of pipe beginning at  $H-2$ , we will call the hanger force at this point  $H-2''$ .



Also, note that we have considered the weight of the 90° bend acting at the center of gravity of the bend. The distance  $B$  is determined from the Chart on page 11 which has been drawn for convenience:

$$B = \text{Radius} \times .637, \text{ or } 5 \text{ ft.} \times .637 = 3.185 \text{ ft.}$$

### Step 1 – Taking moments about axis Y-Y' (Figure 2)

$$\begin{aligned} \sum M_{y-y'} = 0, & \quad 1.81(1418) + 8(1084) - 11(H-2') = 0 \\ & \quad 2,567 + 8,672 = 11(H-2') \\ & \quad H-2' = 1,022 \text{ lb.} \end{aligned}$$

### Step 2 – Taking moments about axis X-X' (Figure 2)

$$\begin{aligned} \sum M_{x-x'} = 0, & \quad 1.81(1418) + 6.5(542) - 7(H-1) + 9.5(3,533) - 11(A) = 0 \\ & \quad 2,567 + 3,523 + 33,564 = 7(H-1) + 11(A) \\ & \quad 39,564 = 7(H-1) + 11(A) \end{aligned}$$

### Step 3 – Adding Forces $\sum V = 0$ ,

$$\begin{aligned} A + H-1 + H-2' - 3,533 - 542 - 1,418 - 1,084 &= 0 \\ A + H-1 + H-2' &= 6,577 \text{ lb.} \end{aligned}$$

Substituting the value  $H-2'$ , calculated as 1,022 lb. in Step 1,

$$\begin{aligned} A + H-1 + 1,022 &= 6,577 \text{ lb.} \\ A &= 5,555 - H-1 \end{aligned}$$

### Step 4 – Solving the Three Equations

- (1)  $H-2' = 1,022$  Step I
- (2)  $39,654 = 7(H-1) + 11(A)$  Step II
- (3)  $A = 5,555 - (H-1)$  Step III

Solving Equation (2) by substituting for  $A = 5555 - H-1$ ,

$$\begin{aligned} 39,654 &= 7(H-1) + 11(5,555 - H-1) \\ H-1 &= 5,363 \text{ lb.} \end{aligned}$$

Substituting for  $H-1$  in Equation 3,

$$A = 5,555 \text{ lb.} - 5,363 \text{ lb.}$$

$A = 192 \text{ lb.}$ ; which is below the allowable load at  $A$  of 500 lb.

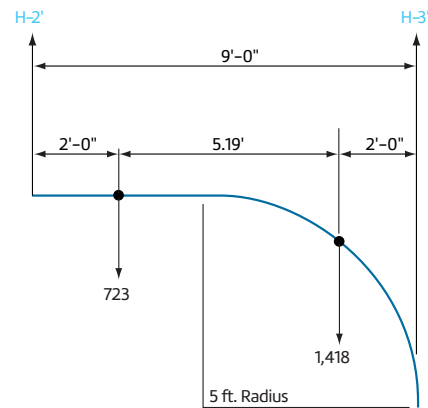
Next, consider the section of pipe between  $H-2$  and  $H-3$  to determine the weight distribution, between these two points, of the 4ft. section of pipe and the five diameter bend.

$$\begin{aligned} \sum M_{H-2} = 0, & \quad 2(723) + 7.19(1418) - 9(H-3') = 0 \\ & \quad H-3' = 1,293 \text{ lb.} \end{aligned}$$

$$\begin{aligned} \sum M_{H-3} = 0, & \quad 1.81(1,418) + 7(723) - 9(H-2'') = 0 \\ & \quad H-2'' = 848 \text{ lb.} \end{aligned}$$

$$H-2 = H-2' + H-2'' = 1,022 \text{ lb.} + 848 \text{ lb.} = 1,870 \text{ lb.}$$

FIGURE 3 – Elevation View



In the next free body diagram (Figure 4) consider the 65 ft. vertical section of the piping system to determine the supporting forces for  $H-3''$  and  $H-4'$ .

It is apparent that the combined forces  $H-3''$  and  $H-4'$  equals 65 ft. x 180.7 lb./ft. Further, both  $H-3''$  and  $H-4'$  could be any value, provided the relationship

$$H-3'' + H-4' = 11,746 \text{ lb.}$$

is maintained. It is not recommended, however, to select arbitrary values for these two forces; instead, the load for each hanger should be such that the elevation of the pipe attachment is above the midpoint of the length of pipe supported by the hanger. Thus, the support will be located above the point where one could consider the weight of the pipe column acting, thereby avoiding a condition where the location of the support lends itself to the "tipping" tendency of the pipe when the support is located below this point.

Since there is 10 ft. of vertical pipe above  $H-3''$  and 40 ft. of pipe between  $H-3''$  and  $H-4'$ , let  $H-3''$  support 10 ft. plus 30 ft. of pipe load:

$$H-3'' = (10 \text{ ft.} + 30 \text{ ft.})(180.7 \text{ lb./ft.}) = 7,228 \text{ lb.}$$

Since  $H-3 = H-3' + H-3''$  and  $H-3' = 1293 \text{ lb.}$  (see Figure 3),

$$H-3 = 1,293 \text{ lb.} + 7,228 \text{ lb.} = 8,521 \text{ lb.}$$

$$H-4' = (10 \text{ ft.} + 15 \text{ ft.})(180.7 \text{ lb./ft.}) = 4,518 \text{ lb.}$$

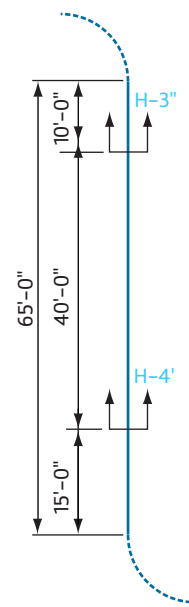
Consider the piping between  $H-4'$  and  $H-5$  to determine the weight distribution of the 5 diameter bend and the 5 ft. of horizontal pipe:

$$\begin{aligned} \sum M_{H-4} = 0 & \quad 1.81(1,418) + 7.5(904) - 10(H-5') = 0 \\ & \quad H-5' = 935 \text{ lb.} \end{aligned}$$

$$\begin{aligned} \sum M_{H-5} = 0 & \quad 2.5(904) + 8.19(148) - 10(H-4'') = 0 \\ & \quad H-4'' = 1,387 \text{ lb.} \end{aligned}$$

$$H-4 = H-4' + H-4'' = 4,518 \text{ lb.} + 1,387 \text{ lb.} = 5,905 \text{ lb.}$$

FIGURE 4 – Elevation View



# Hanger Load Calculations

FIGURE 5

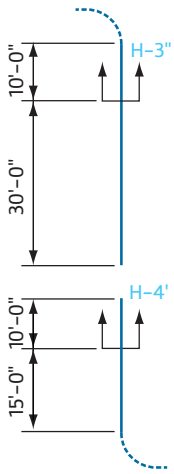


FIGURE 6 – Elevation View

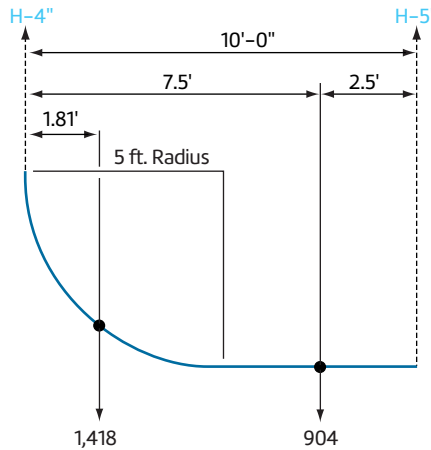
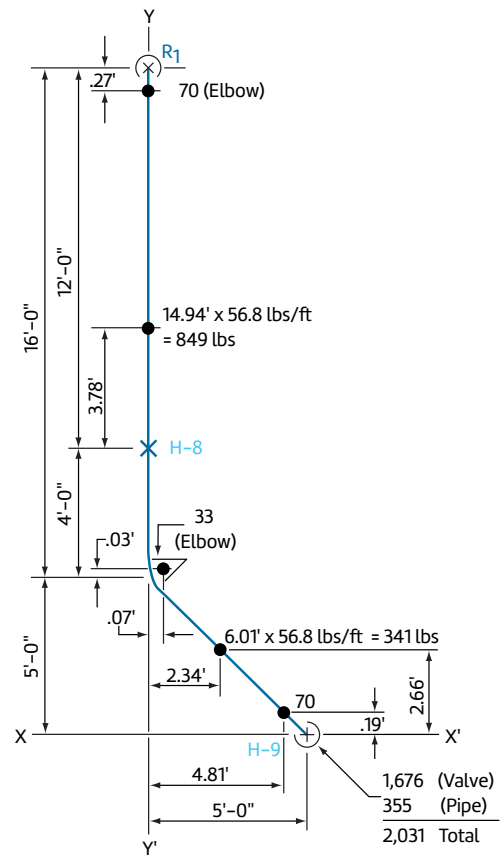


FIGURE 7 – Plan View



It is obvious that some portion of the weight of the 6 in. pipe between the 12 in. line and H-8 must be supported by H-5 and H-6. Therefore, before proceeding through H-5 and H-6, calculate this pipe weight load R<sub>1</sub>, and introduce it into the free body diagram for H-5 and H-6.

$$\sum M_{y-y} = 0 \quad .07(33) + 2.34(341) + 4.81(70) + 5(2,031) - 5(H-9) = 0$$

$$H-9 = 2,258 \text{ lb.}$$

$$\sum M_{x-x'} = 0 \quad 19(70) + 2.66(341) + 5.03(33) - 9(H-8) + 12.78(849) + 20.73(70) - 21R_1 = 0$$

$$13,387 = 9(H-8) - 21(R_1)$$

$$\sum V = 0, \quad R_1 + H-8 + H-9 - 2,031 - 70 - 341 - 33 - 849 - 70 = 0$$

$$R_1 + H-8 + H-9 = 3,394 \text{ lb.}$$

Since H-9 has been calculated as 2,258 lb.

$$R_1 + H-8 = 3,394 \text{ lb.} - 2,258 \text{ lb.} = 1,136 \text{ lb.}$$

$$H-8 = 1,136 \text{ lb.} - R_1$$

Substituting this value for H-8 in the Equation

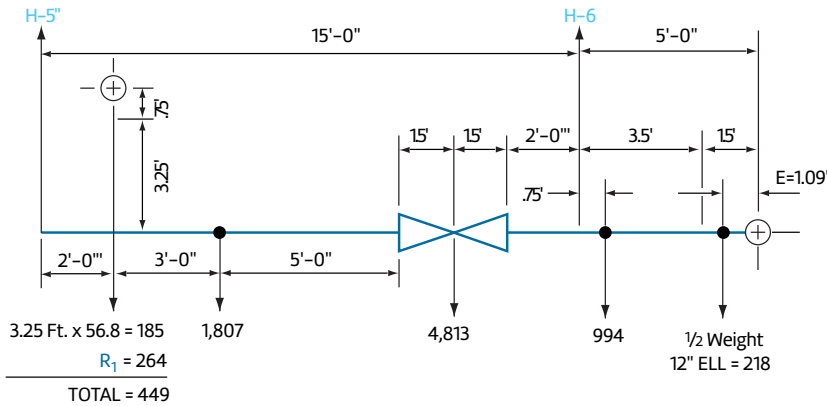
$$13,387 = 9(H-8) + 21R_1$$

$$13,387 = 9(1,136 \text{ lb.} - R_1) + 21(R_1)$$

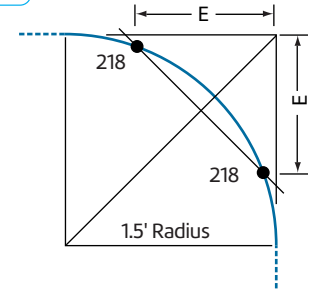
$$R_1 = 264 \text{ lb.}$$

$$H-8 = 1,136 - R_1 = 1,136 \text{ lb.} - 264 \text{ lb.} = 872 \text{ lb.}$$

**FIGURE 8 – Elevation View**



**FIGURE 9**



Dimension E is determined from the Chart on page 11.

For the sample problem,  
 $E = .726 \times 1.5 \text{ ft.} = 1.09 \text{ ft.}$

The free body diagram shown in Figure 8 extends from H-5 through the 12 in. 90° elbow. This is intended to illustrate that the weight of the 90° elbow may be considered as supported on a beam which passes through the center of gravity of the elbow and rests on the extensions of the tangents as shown in Figure 9.

In Figure 8,

$$\Sigma M_{H-5} = 0, \quad 2(449) + 5(1,807) + 11.5(4,813) - 15(H-6) + 15.75(994) + 18.91(218) = 0$$

$$H-6 = 5,671 \text{ lb.}$$

$$\Sigma M_{H-6} = 0, \quad 3.5(4,813) + 10(1,807) + 13(449) - .75(994) - 3.91(218) - 15(H-5) = 0$$

$$H-5 = 2,610 \text{ lb.}$$

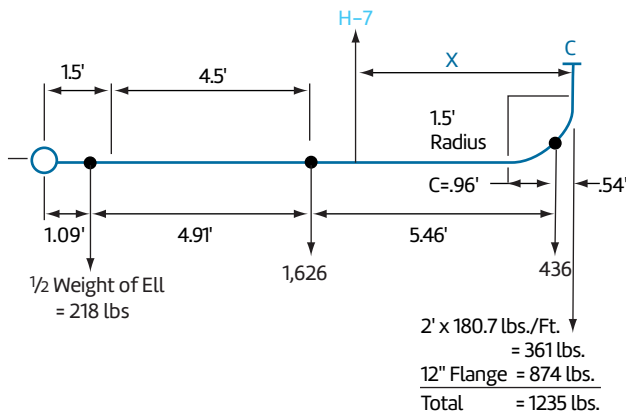
$$H-5 = H-5' + H-5'' = 935 \text{ lb.} + 2,610 \text{ lb.} = 3,545 \text{ lb.}$$

Solving for distance X,

$$\begin{aligned} \Sigma M_C = 0, \\ .54(436) - X(H-7) + 6(1,626) + 10.91(218) = 0 \\ X(H-7) = 12,369 \\ X(3515) = 12,369 \\ X = 3.52 \text{ ft.} \end{aligned}$$

As a final step, check to ensure that the weight of the entire piping system is equal to the total supporting forces of the hangers plus the pipe weight load to be supported by the equipment connections:

**FIGURE 10 – Elevation View**



The Figure 10 diagram shows a method for arriving at the location of H-7 which will allow zero load on connection C.

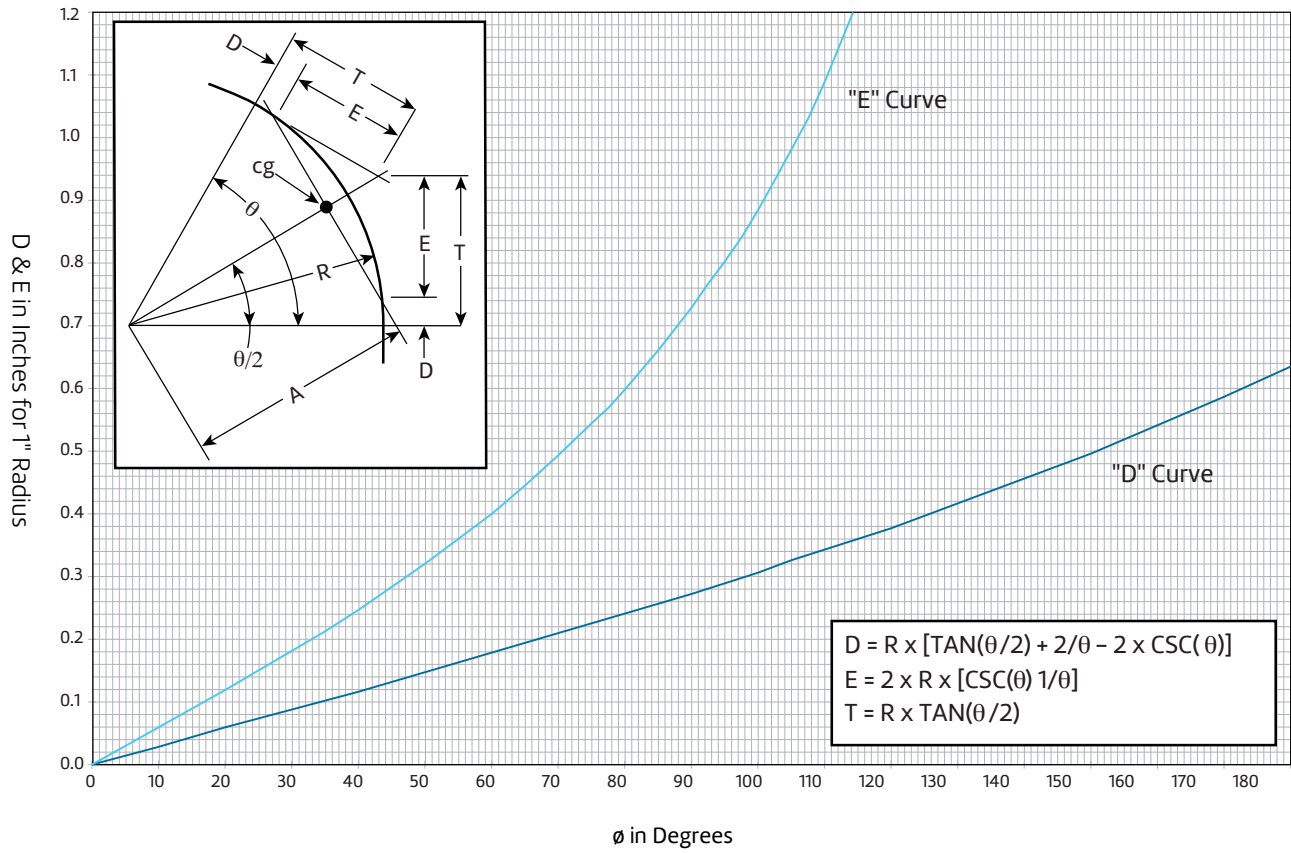
The value of H-7 is equal to the weight of the piping section:

$$H-7 = 218 \text{ lb.} + 1,626 \text{ lb.} + 436 \text{ lb.} + 1,235 \text{ lb.} = 3,515 \text{ lb.}$$

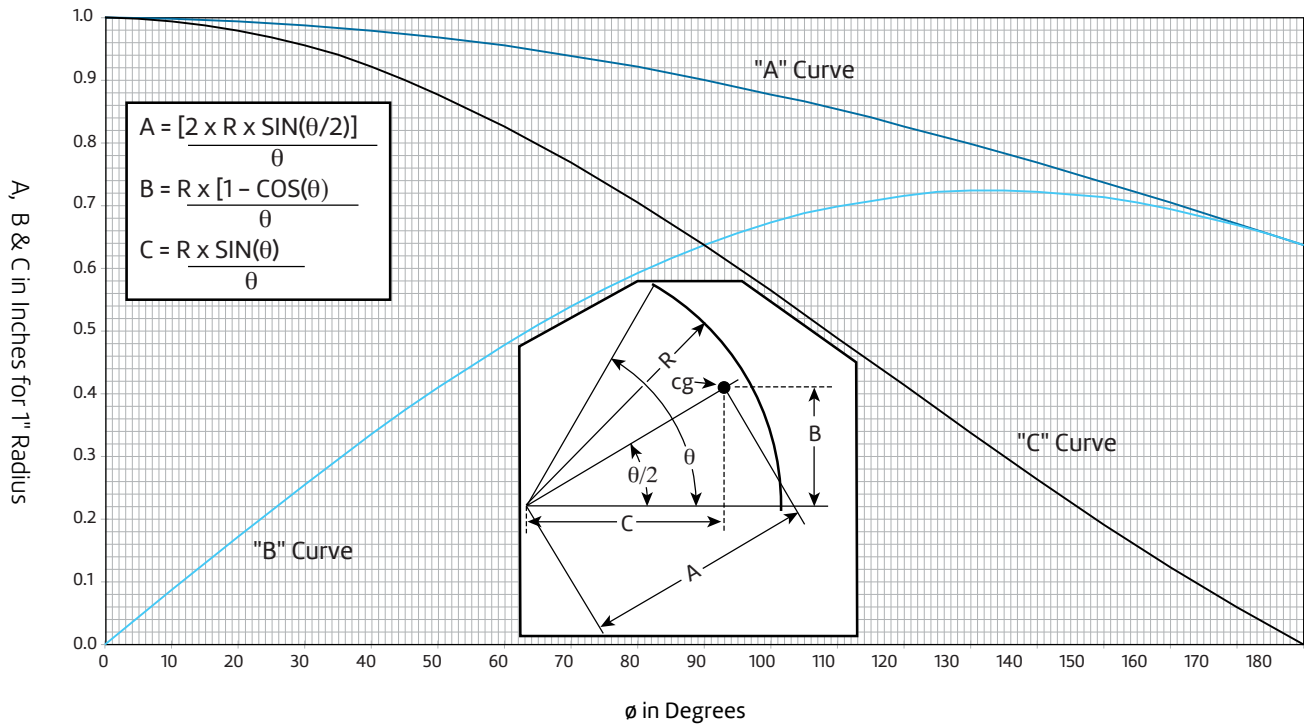
**Summary – Support Forces**

Piping System	Weight (Lbs)	Support Forces Plus Terminal Point Loads, lb
109.5 ft. of 12" Pipe @ 180.7 lb./ft.	19,787	A = 192
(3) 12" 5 Dia. Bends @ 1418 lb.	4,254	H-1 = 5,363
(2) 12" 90° L.R. Ells @ 436 lb.	872	H-2 = 1,870
30.45 ft. of 6" Pipe @ 56.8 lb./ft.	1,730	H-3 = 8,521
(2) 6" 90° L.R. Ells @ 70 lb..	140	H-4 = 5,905
(1) 6" 45° Ell @ 33 lb.	33	H-5 = 3545
(1) 12" 1,500 lb. Check Valve @ 3,533 lb.	3,533	H-6 = 5,671
(1) 12" 1,500 lb. Gate Valve @ 4,813 lb.	4,813	H-7 = 3,515
(1) 12" 1,500 lb. WN Flange @ 874 lb.	874	H-8 = 872
(1) 6" 1,500 lb. Gate Valve @ 1,676 lb.	1,676	H-9 = 2,258
<b>Total Weight of Piping System.</b>	<b>37,712</b>	<b>Total = 37,712</b>

Calculated Arc Distances for Bends and Welding Elbows



Center of Gravity of an Arc



## Thermal Movements

The next step in the design of pipe hangers involves the calculation of the thermal movements of the pipe at each hanger location. Based on the amount of vertical movement and the supporting force required, the engineer can most economically select the proper type hanger (i.e. Constant Support, Variable Spring, or Rigid Assembly).

The determination of piping movements to a high degree of accuracy necessitates a highly complicated study of the piping system. The simplified method shown here is one which gives satisfactory approximations of the piping movements.

Whenever differences occur between the approximations and actual movements, the approximation of the movement will always be the greater amount.

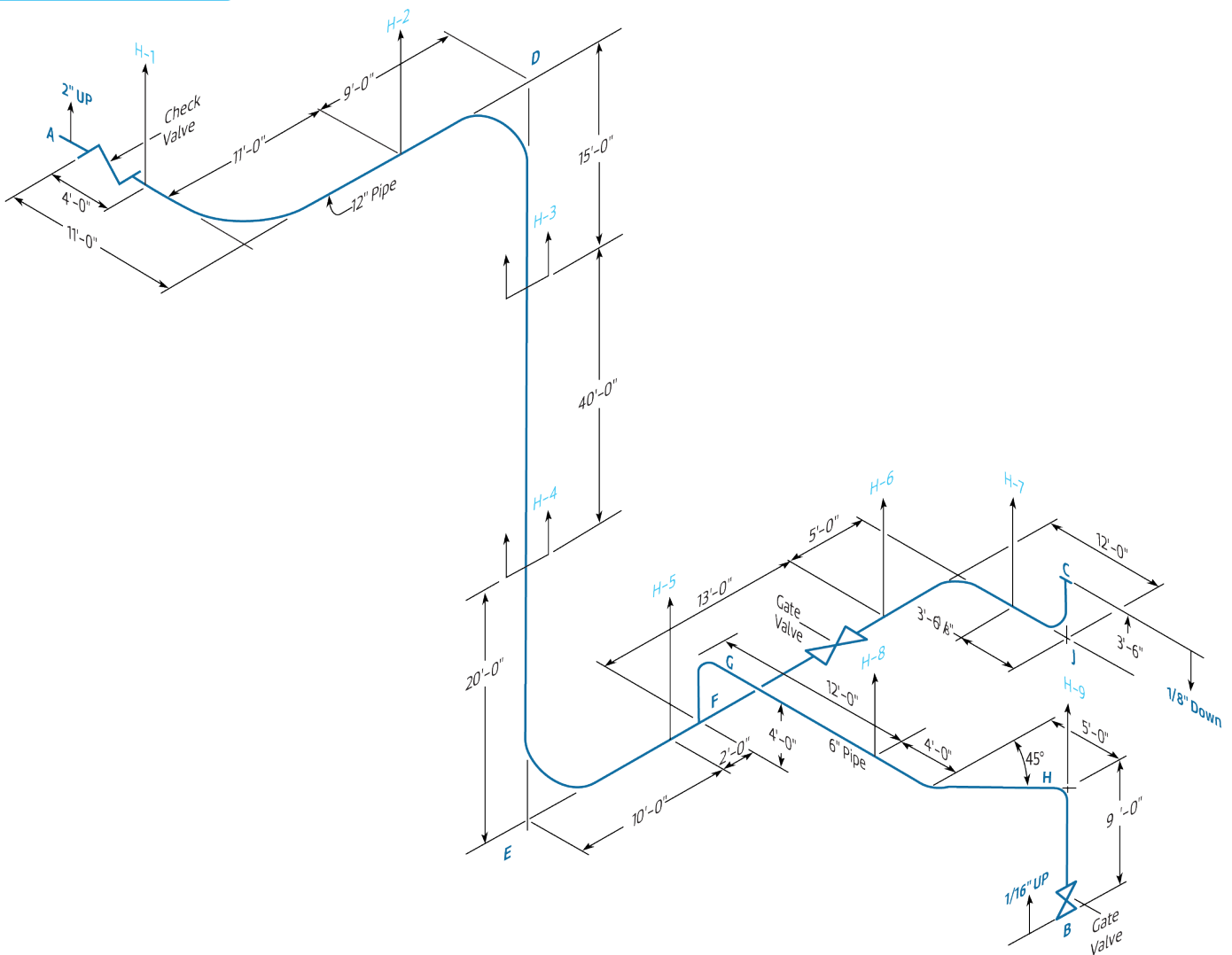
## STEP – Chart Vertical Movements

Draw the piping system of Figure 1 and show all known vertical movements of the piping from its cold to hot, or operating, position (see Figure 11). These movements will include those supplied by the equipment manufacturers for the terminal point connections. For the illustrated problem, the following vertical movements are known:

- Point A -- 2 in. up, cold to hot
- Point B --  $\frac{1}{16}$  in. up, cold to hot
- Point C --  $\frac{1}{8}$  in. down, cold to hot
- H-4 - 0 in., cold to hot

The operating temperature of the system is given as 1,050°F.

FIGURE 11 – Vertical Movements



asc-es.com

Building connections that last™

Referring to the thermal expansion table (page 64), the coefficient of expansion for low-chrome steel at 1,050°F is .0946 in.

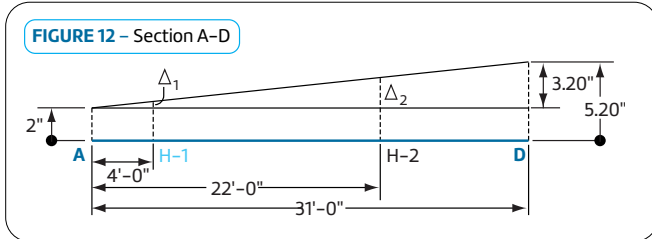
Calculate the movements at points **D** and **E** by multiplying the coefficient of the expansion by the vertical distance of each point from the position of zero movement on the riser **D-E**:

$$55 \text{ ft.} \times .0946 \text{ in./ft.} = 5.2 \text{ in. up at D}$$

$$20 \text{ ft.} \times .0946 \text{ in./ft.} = 1.89 \text{ in. down at E}$$

### STEP 2 – Section – A-D

Make a simple drawing of the piping between two adjacent points of known movement, extending the piping into a single plane as shown for the portion between **A** and **D**.



The vertical movement at any hanger location will be proportional to its distance from the end points:

$$\Delta_1 = \frac{4}{31} \times 3.20 = .41 \text{ in.}$$

The vertical movement at **H-1** = .41 in. + 2 in.

$$\Delta_{H-1} = 2.41 \text{ in. up}$$

$$\Delta_2 = \frac{22}{31} \times 3.20 = 2.27 \text{ in.}$$

The vertical movement at **H-2** = 2.27 in. + 2 in.

$$\Delta_{H-2} = 4.27 \text{ in. up}$$

### STEP 3 – Movement at H-3

To calculate the vertical movement at **H-3**, multiply its distance from **H-4** by the coefficient of expansion.

$$\Delta_{H-3} = 40 \text{ ft.} \times .0946 \text{ in./ft.} = 3.78 \text{ in. up}$$

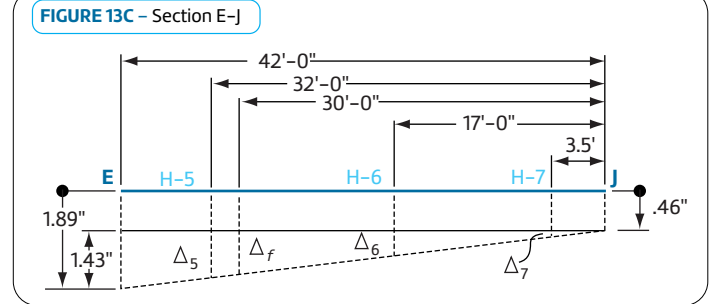
$$\Delta_{H-3} = 3.78 \text{ in. up}$$

### STEP 4 – Section – E-J

The next section with two points of known movement is the length **E-J**. Movement at **E** was calculated as 1.89 in. down.

Movement at **J** is equal to the movement at the terminal point **C** ( $\frac{1}{8}$  in. down) plus the amount of expansion of the leg **C-J**:

$$\Delta_J = .125 \text{ in.} + (3.5 \text{ ft.} \times .0946 \text{ in./ft.}) = .46 \text{ in. down}$$



$$\Delta_7 = \frac{3.5}{42} \times 1.43 = 0.12 \text{ in.}$$

$$\Delta_{H-7} = 0.12 \text{ in.} + 0.46 \text{ in.} = 0.58 \text{ in. down}$$

$$\Delta_6 = \frac{17}{42} \times 1.43 = 0.58 \text{ in.}$$

$$\Delta_{H-6} = 0.58 \text{ in.} + 0.46 \text{ in.} = 1.04 \text{ in. down}$$

$$\Delta_F = \frac{30}{42} \times 1.43 = 1.02 \text{ in.}$$

$$\Delta_F = 1.02 \text{ in.} + 0.46 \text{ in.} = 1.48 \text{ in. down}$$

$$\Delta_5 = \frac{32}{42} \times 1.43 = 1.09 \text{ in.}$$

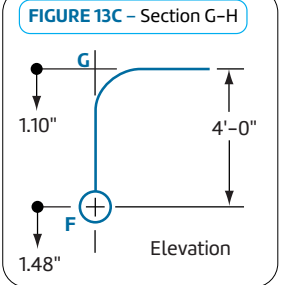
$$\Delta_{H-5} = 1.09 \text{ in.} + 0.46 \text{ in.} = 1.55 \text{ in. down}$$

### STEP 5

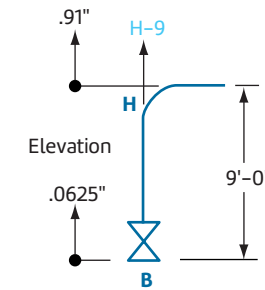
Draw the section **G-H**. The movement at **G** is equal to the movement at **F** minus the expansion of the leg **G-F**:

$$\Delta_G = 1.48 \text{ in. down} - (4 \text{ ft.} \times .0946 \text{ in./ft.})$$

$$\Delta_G = 1.10 \text{ in. down}$$



### FIGURE 15A – Section B-H



The movement at **H** is equal to the movement of the terminal point **B** ( $\frac{1}{16}$  in. up) plus the expansion of the leg **B-H**:

$$\Delta_H = .0625 \text{ in. up} + (9 \text{ ft.} \times .0946 \text{ in./ft.})$$

$$\Delta_H = 0.91 \text{ in. up}$$

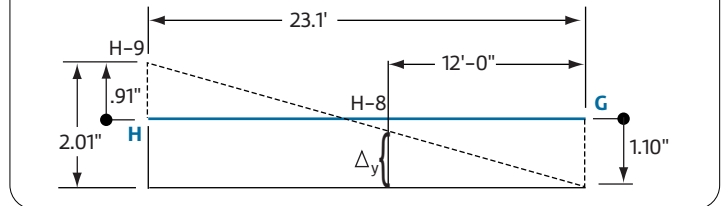
Since **H-9** is located at point **H**,

$$H-9 = \Delta_H = 0.91 \text{ in. up}$$

$$\Delta_Y = \frac{12}{23.1} \times 2.01 \text{ in.} = 1.04 \text{ in.}$$

$$\Delta_{H-8} = 1.10 \text{ in.} - 1.04 \text{ in.} = .06 \text{ in. down}$$

### FIGURE 15B – Section G-H



After calculating the movement at each hanger location it is often helpful, for easy reference when selecting the appropriate type hanger, to make a simple table of hanger movements like the one shown at the right.

#### Hanger No. .... Movement

H-1	2.41" up
H-2	4.27" up
H-3	3.78" up
H-4	0"
H-5	1.55" down
H-6	1.04" down
H-7	0.58" down
H-8	0.06" down
H-9	0.91" up

## Selection of the Proper Hanger

Selection of the appropriate type hanger for any given application is governed by the individual piping configuration and job requirements. Job specifications covering hanger types, however, are of necessity written in broad terms, and some emphasis is placed on the good judgement of the hanger engineer to ensure a satisfactory, yet economical, system.

The type of hanger assemblies are generally classified as follows:

- 1 Flexible hangers, which include hangers of the constant support and variable spring types.
- 2 Rigid hangers, such as rod hangers and stanchions.
- 3 Rollers

The location of anchors and restraints is not usually considered a responsibility of the hanger designer. Since it is necessary to determine the location of anchors and restraints before accurate and final stress analysis is possible, they are considered a part of piping design.

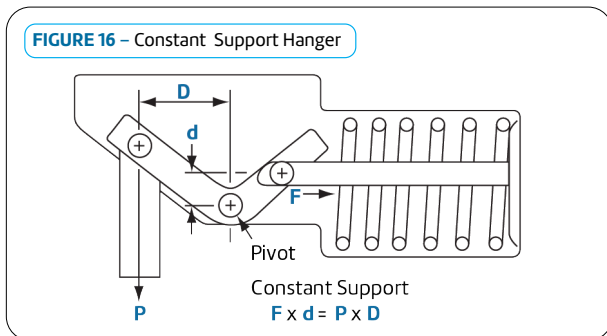
### Flexible Hangers

When a pipe line expands vertically as a result of thermal expansion it is necessary to provide flexible pipe supports which apply supporting force throughout the expansion and contraction cycle of the system.

There are two types of Flexible hangers:

- Variable Spring
- Constant Support

Constant Support hangers provide constant supporting force for piping throughout its full range of vertical expansion and contraction. This is accomplished through the use of a helical coil spring working in conjunction with a bell crank lever in such a way that the spring force times its distance to the lever pivot is always equal to the pipe load times its distance to the lever pivot.



Because of its constancy in supporting effect the Constant Support hanger is used where it is desirable to prevent pipe weight load transfer to connected equipment or adjacent hangers. Consequently, they are used generally for the support of critical piping systems.

Variable Spring hangers are used to support piping subject to vertical movement where Constant Supports are not required.

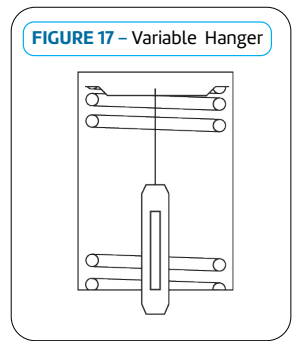
The inherent characteristic of a Variable Spring is such that its supporting force varies with spring deflection and spring scale. Therefore, vertical expansion of the piping causes a corresponding extension or compression of the spring and will cause a change in the actual supporting effect of the hanger.



asc-es.com

Building connections that last™

The variation in supporting force is equal to the product of the amount of vertical expansion and the spring scale of the hanger. Since the pipe weight is the same during any condition, cold or operating, the variation in supporting force results in pipe weight transfer to equipment and adjacent hangers and consequently additional stresses in the piping system. When Variable Spring hangers are used, the effect of this variation must be considered.



Variable Spring hangers are recommended for general use on non-critical piping systems and where vertical movement is of small magnitude on critical systems. Accepted practice is to limit the amount of supporting force variation to 25% for critical system applications on horizontal piping.

To illustrate the difference in the effect of using a Variable Spring as compared with a Constant Support hanger, refer to the sample problem shown in Figure 1, page 6.

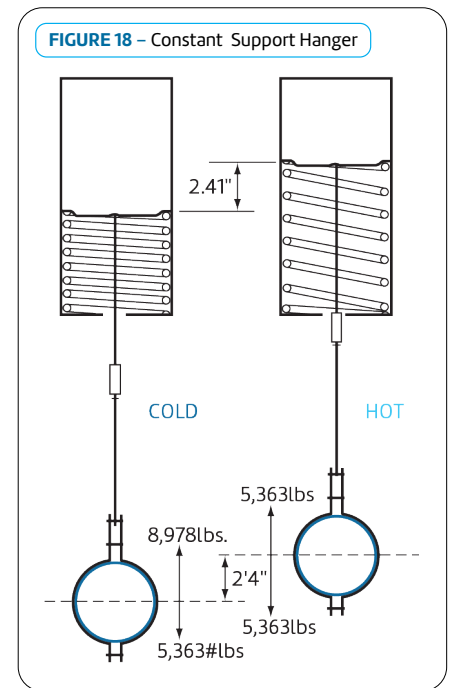
The load for Hanger H-1 was calculated as 5,363 lb. The vertical movement at H-1 was calculated as 2.41 in. up, from the cold to the hot position of the pipe.

If a Variable Spring hanger were used at H-1, the effect of the variation in supporting force would have to be considered. The amount of variation can be determined by multiplying the spring scale in lbs./in. by the amount of vertical expansion in inches.

For example, if the Anvil Figure B-268 Variable Spring Hanger were considered, the proper spring size would be number 16 which has a spring scale of 1,500 lbs./in. (For convenience, we have neglected the weight of the pipe clamp, rod and hex nuts. In designing hangers for an actual problem, the weight of components should be added to the calculated load.)

The amount of variation is 1,500 lb/in. x 2.41 in. = 3,615 lb. Standard practice is to calibrate the hanger in such a way that when the piping is at its hot position the supporting force of the hanger is equal to the calculated load of the pipe. This means that the maximum variation in supporting force occurs when the piping is at its cold position, when stresses added to the piping as a result of variations in supporting forces are less critical. The hot load for the variable spring, then is 5,363 lb.

As the direction of movement from cold to hot is upward, the cold load is 5,363 lb. + 3,615 lb., or 8,978 lb. Figure 18 shows the pipe and spring in both the cold and hot condition.



The purpose of the considerations given to the variation in supporting effect is apparent when you recall that the pipe weight does not change throughout its cold to hot cycle, while the supporting force varies. In **Figure 18** (hot condition), the supporting force is equal to the pipe weight. However, in the cold condition, the supporting force is 8,978 lb. while the pipe weight is 5,363 lb. The hanger would exert an unbalanced force on the pipe equal to the amount of variation, or 3,615 lb. Most of this force would be imposed directly on connection A, where limits are established for the force which may be applied.

Further, safe piping design must be based on total pipe stress which includes bending, torsional, shear, longitudinal, and circumferential stresses. The addition of large forces resulting from spring variations can cause stresses which will greatly reduce the factor of safety of the entire spring system.

It is possible to reduce the amount of variability by using a variable spring which has a smaller spring scale, as an **Anvil Figure 98 (Variable Spring Hanger)**.

The **#16 Figure 98** has a spring scale of 750 lb/in., one-half that of the B268. The amount of variability would be reduced by one-half, or  $2.41 \times 750 = 1,808$  lb. However, it should be obvious that even this change in supporting force is too great for the critical location at **H-1**.

The appropriate hanger type for **H-1** is a constant support hanger. This hanger would be calibrated to the calculated pipe weight. It would apply a constant supporting force, ensuring complete support of the pipe throughout the piping expansion.

That is, its supporting force would be 5,363 lb. when the pipe was at its cold position, and 5,363 lb. also when the pipe was at its hot position.

Hanger **H-2** has a calculated load of 1,870 lb. The vertical movement at this location is 4.27in. up, cold to hot. Although the load may be considered slight, the magnitude of the vertical movement is great, and a considerable amount of supporting force change would occur if a variable spring were used.

For example, the appropriate size variable spring is a **#12 Figure 98** (the 4.27 in. travel is beyond the travel capacity of the **Figure B-268**), which has a spring scale of 225 lb. in. The amount of variation equals  $4.21 \text{ in.} \times 225 \text{ lb. in.},$  or 947 lb.

This variation, expressed as a percentage, is  $947 \text{ lb.}/1,870 \text{ lb.} \times 100,$  or greater than 50%.

Unless the hanger engineer were willing to perform some rather elaborate stress calculations to determine the effect of this variation, it would be safer to apply the accepted rule which limits variability to 25% for critical systems, and rule out the selection of a variable spring in favor of the constant support type hanger.

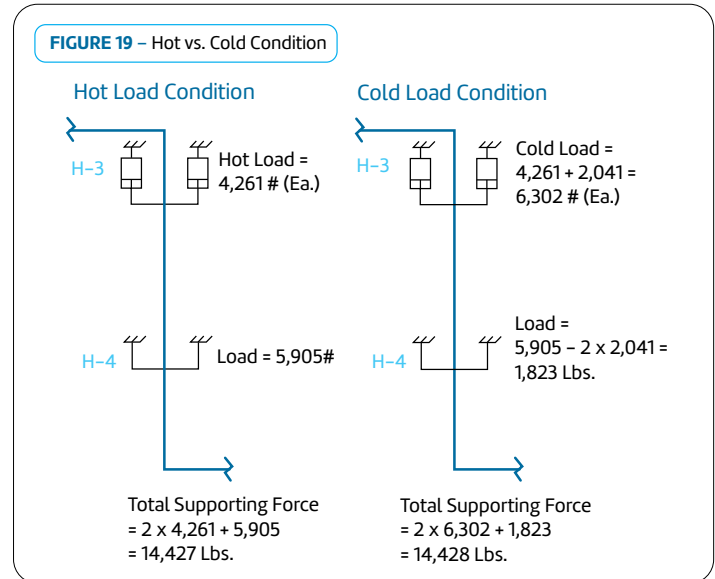
The vertical movement of the pipe at **H-3** was calculated as 3.78 in. up, and the load as 8,521 lb.

In selecting the spring type for the hanger assembly, it should be recognized that any variation in supporting force will not produce bending stresses in the piping system. As the supporting forces at **H-3** and **H-4** are concurrent, no bending is produced as a result of spring variation at **H-3**. Rather, any supporting force variation will merely result in a corresponding load change at the rigid hanger **H-4**.

The hanger type for **H-3** may be variable spring type. It is only necessary that the variable spring have a travel capacity which is greater than the calculated pipe movement of 3.78 in.

Such a variable spring hanger is the **Figure 98**, which has a working travel range of 5 inches.

As this assembly is a riser "trapeze" type, two spring units will be used, each supporting one-half the total load of 8,521 lb, or 4,261 lb. The appropriate size hanger is a **#15 Figure 98** with a spring scale of 540 lb. inch. The amount of variation per spring is  $3.78 \text{ in.} \times 540 \text{ lb./in.},$  or 2,041 lb. The hot load setting for each hanger is equal to  $\frac{1}{2}$  the calculated load, or 4,261 lb. As the direction of movement, cold to hot, is upward, the cold load setting will be  $4,261 \text{ lb.} + 2,041 \text{ lb.} = 6,302 \text{ lb.}$



**Figure 19** shows the supporting forces at **H-3** and **H-4** when the pipe is at its cold and its hot position. The weight of riser clamps, rods, etc., are not included, for convenience.

The design load for **H-3** should allow for a calculated cold load of  $6,302 \text{ lb.} \times 2 = 12,604 \text{ lb.}$

The load at rigid hanger **H-4** is 1,823 lb. cold, 5,905 lb. hot. All hanger components should be designed for the larger load.

Variation in supporting forces at hangers **H-5**, **H-6**, **H-7** and **H-9** will produce reactions at connections B and C. As one of the requirements of the problem under study is that weight loads at B and C shall be zero, these hangers must be of the constant support type.

Although it holds true that at **H-8** any hanger force variation will cause weight loads at B and C, the load and movement at this hanger location are so slight that the spring variation effect can be considered negligible. The load was calculated as 872 lb, the movement as .06 in. down. The variability of a **#8 Figure B-268** is  $.06 \text{ in.} \times 150 \text{ lb./in.},$  or 9 lb. For practical purposes, a 9 lb. change in supporting force could be neglected and a variable spring selected for Hanger **H-8**.

The selection of hanger types for supports **H-1** through **H-9** in the sample problem illustrates the many considerations which should be given in selecting the appropriate flexible hanger at each support location for any major piping system.



In selecting flexible hanger types the engineer should consider that:

- Wherever constant support hangers are used, the supporting force equals the pipe weight throughout its entire expansion cycle, and no pipe weight reactions are imposed at equipment connections and anchors.
- Wherever variable spring hangers are used, the engineer must check to assure that the total variation in supporting effect does not result in harmful stresses and forces within the piping system.
- Where piping stresses and reactions are known to be close to allowable, the simplest and, in the long run, most economical type of flexible support is obviously the constant support hanger.
- Where piping stresses and end reactions are known to be low, variable spring hangers can be used satisfactorily for most non-critical piping support, and for the support of critical systems where vertical movements are of small magnitude.

### Rigid Hangers

Rigid hangers are normally used at locations where no vertical movement of the piping occurs.

The design considerations for a rigid hanger are pipe temperature, for selection of appropriate pipe clamp material, and load, for selection of components suitable for the pipe weights involved.

Pipe clamp material is usually carbon steel for temperatures up to 750°F, and alloy steel for temperatures above 750°F. Malleable iron pipe clamps may be used at temperatures up to 450°F.

For piping systems of low operating temperature, where vertical expansion is usually not a factor, the rigid hanger assembly components are selected and designed on the basis of calculated or approximated loads.

In some instances, however, the rigid hanger is used in a manner where it does more than merely support the pipe weight, but acts as against vertical piping movements. It is in these cases that the engineer should exercise care in the location of the rigid hanger and the design load he uses in the selection of components.

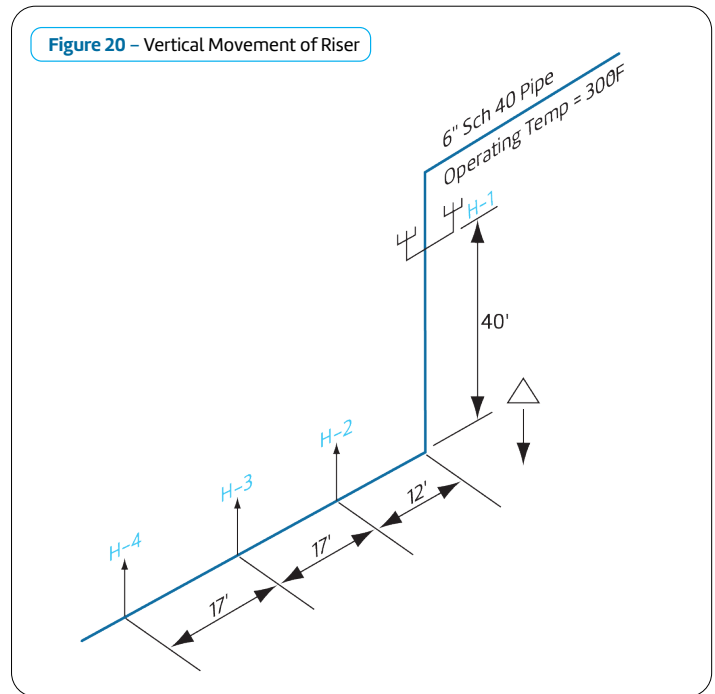
The location and effect of any restraint, guide or anchor on a high temperature and high pressure system is of necessity a function of the stress analyst. The indiscriminate placing of a restraining device on a piping system could alter the piping stresses and end reactions to a serious degree, changing a conservatively designed system into one which exceeds the limits of good design practices.

The hanger engineer, though not as well acquainted with the total stress picture of a piping system as is the stress analyst, must usually decide if the problem is of this "critical" nature, or whether the system under study is such that the effect of adding a restraint for convenience will be negligible. The decision is based on the factors of operating temperature, operating pressure, and the configuration of the system. Recognizing that pipe design is based on total pipe stress, one must determine whether the stresses produced by the addition of a rigid hanger, or vertical restraint, are critical.

This article is not intended to present a short-cut method for the stress analysis of a piping system. In any instance where it is not obvious to an engineer that he is dealing with a noncritical case, the problem should either be reviewed formally from a total stress view-point, or the decision to use a rigid hanger should be changed and a flexible support be utilized.

This article is intended to provide the engineer with a simple and quick method of deciding how he can most economically treat vertical thermal movement on a long, horizontal section of a non-critical piping system. Often, the problem can be expressed in the simple terms of whether he will be able to use a rigid hanger rather than a flexible hanger without producing obviously harmful stresses in the system.

Consider a simple example, shown in Figure 20, where the hanger engineer is confronted with the problem of how to best treat vertical movement resulting from thermal expansion of the riser. The horizontal sections at both the top and the bottom of the riser are of any hangers H-2, H-3, H-4, etc., should be spring hangers and which will be rigid hangers (vertical restraints in this instance). The solution must satisfy a condition that the bending stress produced by the restraining action of the hanger is no greater than some acceptable amount, say, in this instance, 10,000 psi.



For an operating temperature of 300°F, the expansion for carbon steel pipe is .0182in. per foot.

$$\Delta = 40\text{ft.} \times .0182\text{in./ft.} = .728\text{in. down.}$$

(See "Thermal Movement Calculations"; page 12.)

From the Chart on Page 68 using values of 6 in. pipe and a deflection of  $\frac{3}{4}$  in., read 17.5 ft. This is the minimum distance from the riser where the first rigid hanger may be placed for this problem.

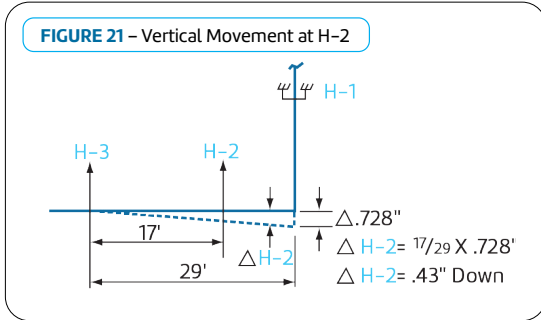
If the locations of the hangers are fixed, as they are for this case, then H-2 must be a spring hanger assembly because it is located only 12 ft. from the riser. Therefore, the nearest rigid hanger will be hanger H-3, located 29 ft. from the riser.



asc-es.com

Building connections that last™

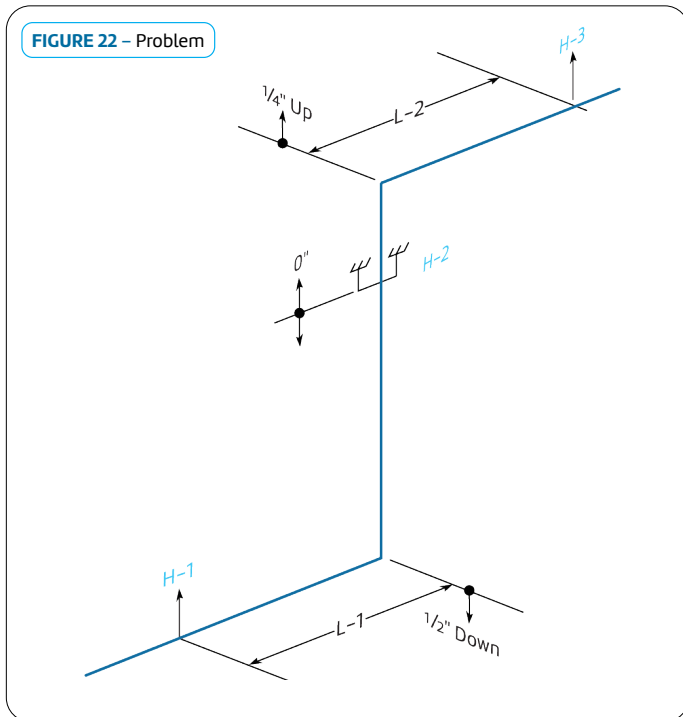
The amount of vertical movement at hanger **H-2** will be proportional to its distance between **H-3** and the riser, and can be approximated as shown in Figure 21:



Thus, **H-2** would be selected as a variable spring hanger for .43 in. of downward vertical movement, and **H-3** would be designed as a rigid hanger.

In the above problem the hanger locations were fixed. If this were not the case, and the hangers could be placed at any convenient location subject to usual hanger span limits, then **H-2** would be placed at any distance 17.5 ft. or more from the riser. This would satisfy the condition that a maximum bending stress of 10,000 psi would result from the restraining effect of the hanger. If the allowable effect was given as a higher stress, then the hanger could be placed closer to the riser; if lower, the nearest rigid hanger would be placed a greater distance from the riser.

If the hanger were located closer to the riser, a greater restraining force would be applied to the pipe by the hanger. As the location is changed to a greater distance from the riser, a lesser force is required. As illustrated in the following sample problem, this force can be an important factor in the design load of the hanger.



## Problems

Given 10 in. Sch. 40 pipe, and allowable bending stress of 10,000 psi produced by the restraining effect of the hangers,

Find:

- 1 L-1 and L-2 the distances to the nearest rigid hangers **H-1** and **H-3**, see Figure 22.
- 2 The forces which the hangers must apply to the pipe to allow the 1/4 in. and 1/2 in. deflections resulting from the thermal expansion of the vertical pipe.

## Solution:

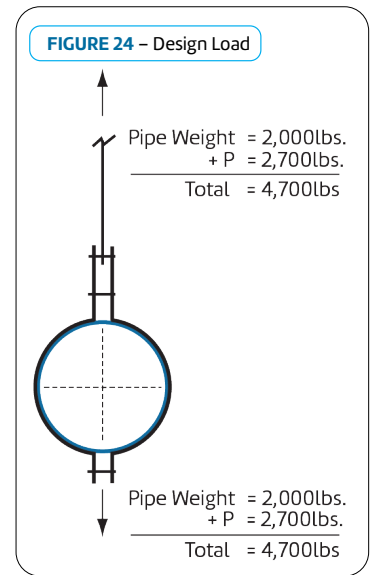
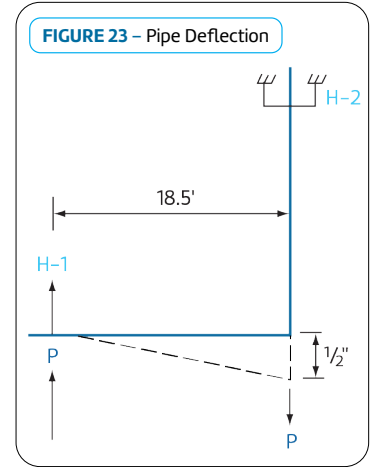
From the Chart on page 68 using values of 1/2 in. deflection and 10 in. pipe, read L-1, as 18.5 ft., the distance from the riser to the rigid hanger **H-1**. Thus, at a distance of 18.5 ft., the hanger will exert sufficient force to deflect the pipe 1/2 in., producing 10,000 psi bending stress. (See Figure 23).

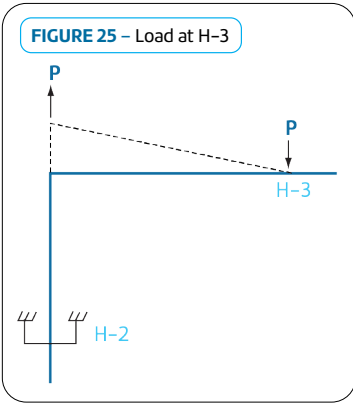
Use the Chart on page 70 to find the value of force P. For a pipe size of 10 in. and a span of 18.5 ft., read P as approximately 2,700 lb.

This force is applied by the pipe hanger **H-1**, and, therefore, must be included in the design load for **H-1**. In this instance, where the piping movement is in the downward direction, the force P is added to the pipe weight to be supported by Hanger **H-1**. If the pipe weight for **H-1** were calculated as 2,000 lb., then the design load for the hanger components is 2,000 lb.+2,700 lb., or 4,700 lb., as shown in Figure 24.

To solve for L-2 refer to the Chart on page 68 and, using values of 1/4 in. deflection and 10 in. pipe, read L-2 as 13 ft., the distance to the proposed rigid hanger **H-3**. As discussed for **H1** of this problem, hanger **H-3** must apply sufficient force to restrain the pipe vertically against the force resulting from the thermal expansion of the vertical piping above **H-2**.

The force P which is required at **H-3** can be determined from the Chart on page 70. Using values for 10 in. pipe and a 13 ft. span, P is approximately 3,800 lb. Since this force restrains the upward movement of the pipe, it should be checked against the pipe weight load to assure that the hanger assembly can exert a force equal to the difference of the force P and the pipe weight load.



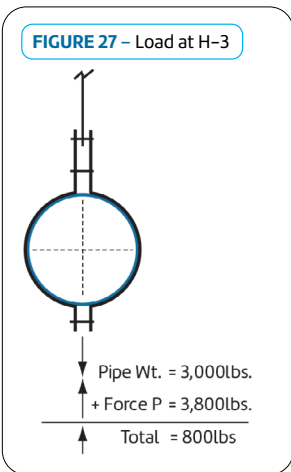


**FIGURE 25 – Load at H-3**

To illustrate, assume that the pipe load at H-3 was calculated as 5,000 lb. The difference between the pipe weight and the force P would equal 5,000 lb. - 3,800 lb. = 1,200 lb., as shown in Figure 26.

The design load used for hanger H-3 should equal 5,000 lb, or pipe weight only in this instance. Where the vertical movement is in the upward direction, and the force P approaches the pipe weight load, the rigid hanger will tend to unload.

This is, as the pipe expands upward the net force applied to the pipe by the hanger becomes less. If the force P becomes greater than the pipe weight at the hanger, the net force on the hanger becomes compressive rather than tensile. When the system has expanded its full amount, the pipe will tend to lift from the hanger, and the supporting effect of the hanger will be zero.



**FIGURE 27 – Load at H-3**

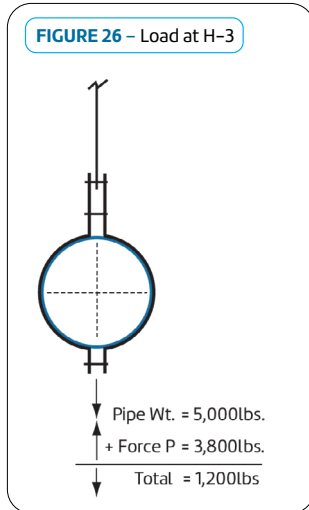
If the pipe weight for the sample problem had been calculated as 3,000 lb., then the net force is 3,000 lb. - 3,800 lb., or 800 lb. upward, as shown in Figure 27.

The hanger, in this case, would not be considered as a support for the pipe, but a vertical restraint against upward movement. Therefore, either a greater span should be used in order to reduce the force P, or a spring hanger should be used if L-2 is maintained as 13 ft., in order to provide support and allow the piping to move upward at this hanger location. Using the values of L-1 and L-2, as determined in the original problem, the forces P at each hanger are as shown in Figure 28.

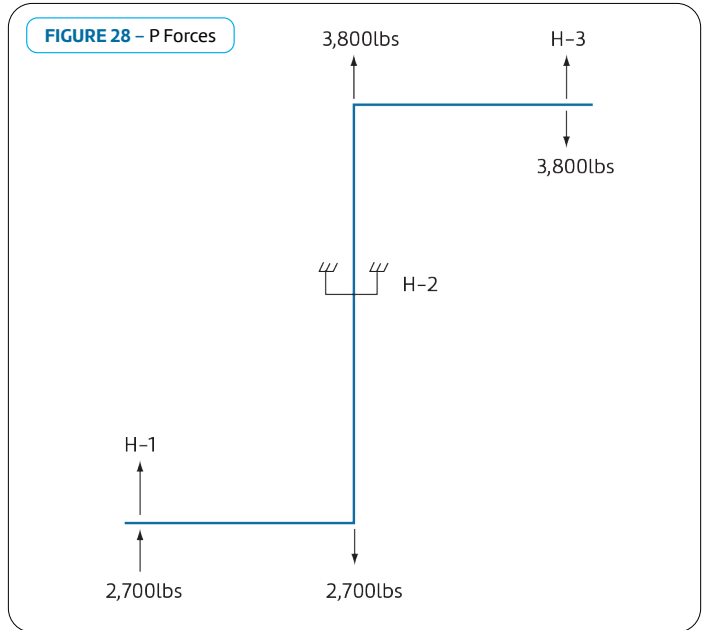
The forces at H-1 and H-3 have been discussed in some detail, but it should also be noted that the design load for H-1 should include these forces as well. For this example, the design load for H-2 equals the pipe weight plus 3,800 lb., minus 2,700 lb, or design load = pipe weight load + 1,100 lb.

In the preceding problems, the allowable bending stress due to the restraining effect of the hanger was given as 10,000 psi.

This allowable stress will, of course, vary with the individual case. Where the stress is other than 10,000 psi, use the Chart on page 68 to read the minimum span, and multiply the span in feet by the factor indicated in the



**FIGURE 26 – Load at H-3**

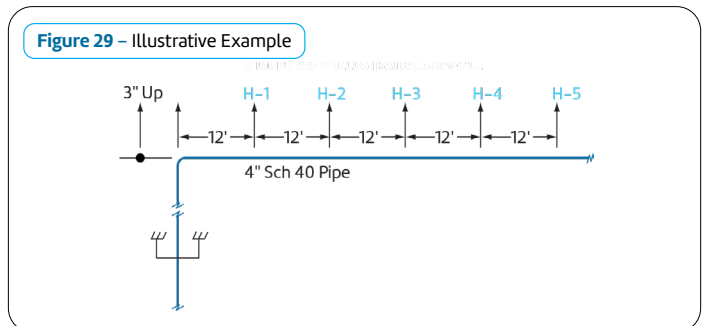


**FIGURE 28 – P Forces**

#### Correction Factor for Stresses Other Than 10,000 PSI

For Bending Stress (PSI) Of:	Multiply Length By:
2,000	2.24
3,000	1.83
4,000	1.58
5,000	1.41
6,000	1.29
8,000	1.12
10,000	1.00
12,000	.91
15,000	.82
20,000	.71

#### Illustrative Example



**Figure 29 – Illustrative Example**

Chart above for the specific stress.

**Given:**

4in. Sch. 40 pipe,  $\Delta = 3$ in., and 3,000 psi maximum bending stress through the restraining effect of the first rigid hanger.

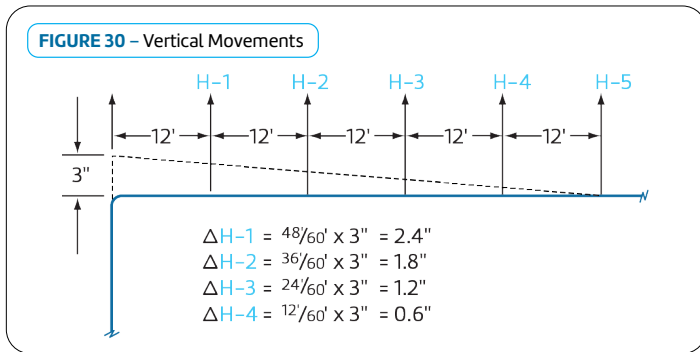
**Find:**

L, the distance from the riser to the first rigid support.

From the Chart on page 68 using values of 4 in. pipe and 3 in. deflection, read a span of 29 ft. This span is based on a stress of 10,000 psi, and, to correct for 3,000 psi, refer to the correction factor chart on the previous page. For a stress of 3,000 psi, the correction factor for spans is 1.83. Multiplying 2 ft. by 1.83, the span for 4 in. pipe with 3 in. deflection at 3,000 psi is  $29 \times 1.83$ , or 53 ft. Thus, L, the minimum distance to the first rigid hanger, is 53 ft.

The first rigid hanger in the above problem will be H-5, located 60 ft. from the riser. The force P required to restrain the piping vertically can be determined from the Chart on page 69 as about 83 lb., using values of 4 in. pipe and a span of 60 ft. The effect of this force will be considered negligible for this problem. The vertical movements at hanger locations between H-5 and the riser are as shown in Figure 30.

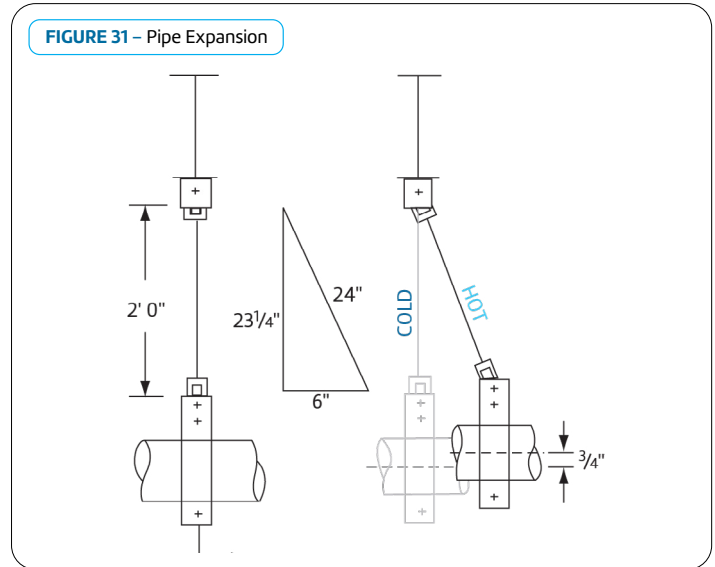
The above results are based on an approximate but conservative analysis. Whenever the appropriate charts are used, the values listed should assist the engineer in arriving at an economical, safe design for any rigid hanger assembly. The examples described represent situations not frequently encountered in pipe support design, but do point out that the rigid hanger in some instances is more than a simple pipe support, and that good design must allow for all applicable conditions.



## Rollers

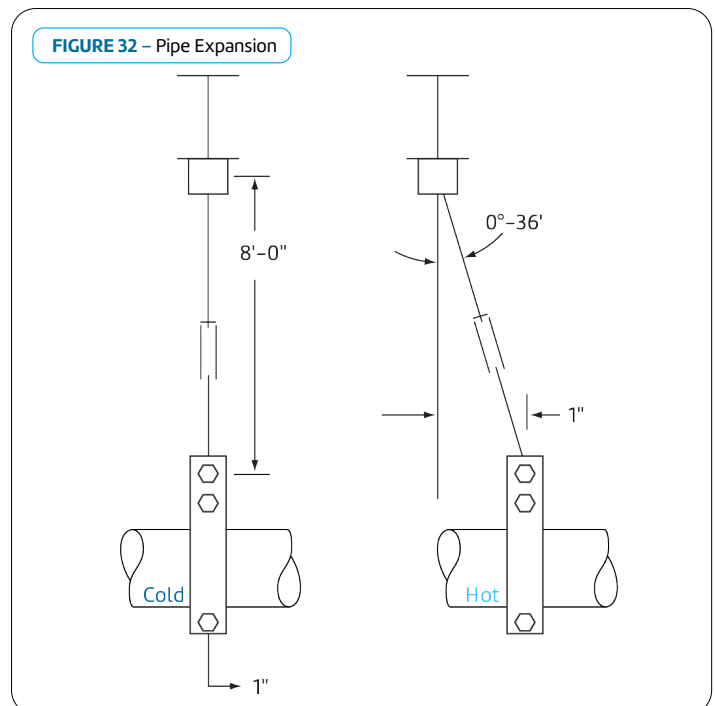
The pipe attachment and structural attachment of a hanger assembly should be such that they will permit the hanger rod to swing to allow for lateral movement of the piping where horizontal pipe expansion is anticipated.

In some instances, where piping expansion is slight and hanger rods are long, the swing permitted by the pivoting of the rod at the upper and lower connections is sufficient, as shown in Figure 31.

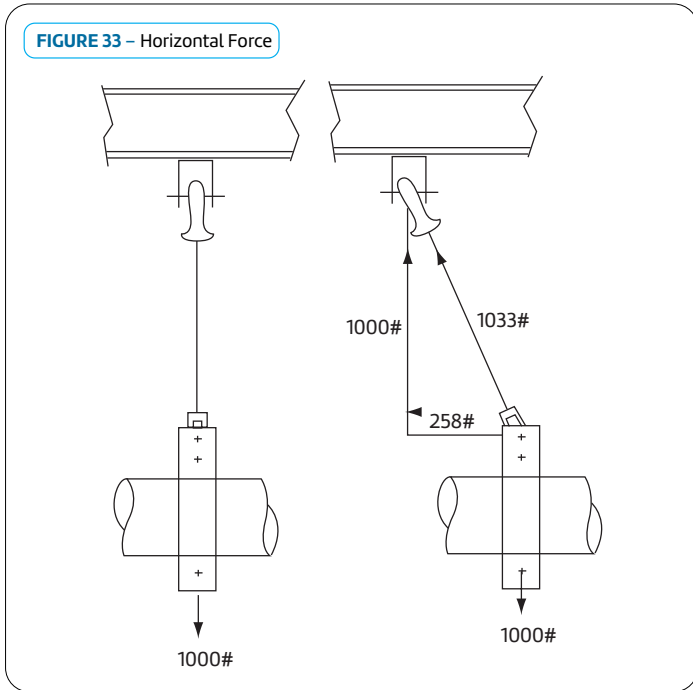


In other instances the angularity caused by the horizontal piping movements can appreciably effect the position of the piping system, and can cause harmful horizontal forces within the piping system.

In Figure 32, note that, because of the large axial piping movement and short hanger rod, the pipe is pulled  $\frac{3}{4}$  in. off elevation when it expands 6 in. horizontally.

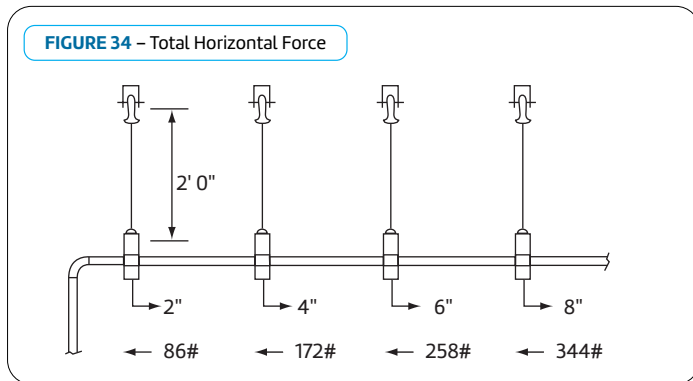


The condition shown in Figure 32 also places a horizontal force component into the piping system. For example, assume a pipe weight of 1000 lb. for the above hanger, as in Figure 33.



The 258 lb. horizontal force by itself may not be of great consequence, but where there is a series of hangers located on the same long section of pipe, the effect of the total horizontal force can be serious. (See Figure 34)

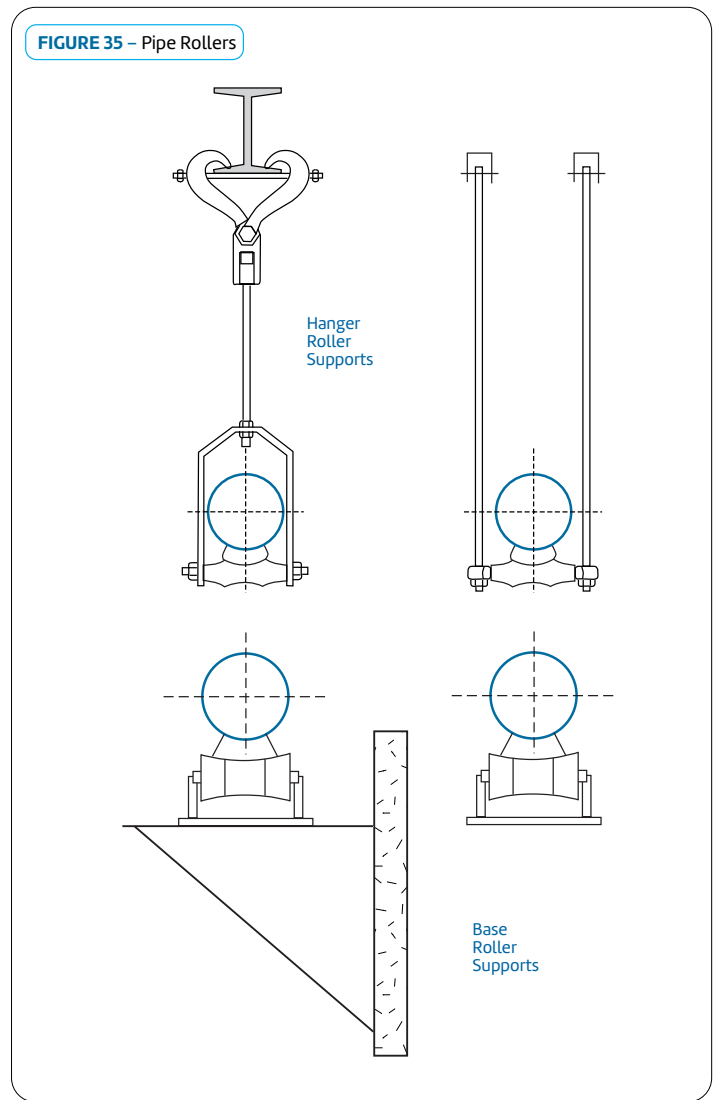
$$\text{Total horizontal force} = 86 + 172 + 258 + 344 = 860 \text{ lb}$$



Certainly, for any system subject to horizontal expansion, the rod angularity from the vertical will result in a horizontal force component. The point where this angularity becomes critical cannot be defined for every case, but accepted practice is to limit the swing from the vertical to 4°.

Where this angle is greater than 4°, a pipe roller should be considered.

Pipe roller supports are of two basic types: those which attach to overhead structure, and those which are placed beneath the pipe as



base supports (see Figure 35).

It should be noted that where rollers are required, the pipe operating temperatures usually are sufficiently high that pipe insulation is used to reduce heat loss and for personnel protection. In these cases a pipe covering protection saddle should be used in conjunction with the rollers to keep the insulation from crushing.

Where the piping is not insulated, the pipe will rest directly on the roller. This is common practice for the support of long transmission lines where the gas or fluid transported is not of elevated operating temperatures, but where the pipe run is subject to some change in ambient temperature, as from summer to winter variances.

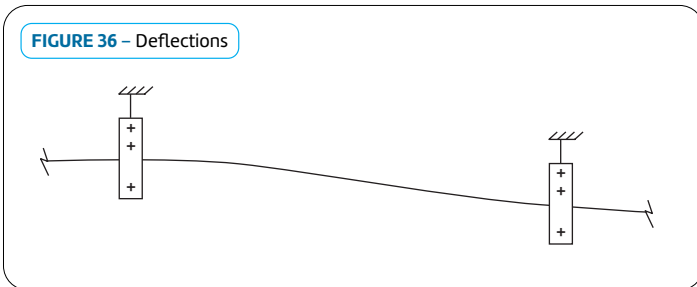
For example, a pipe line 300 ft. long subject to ambient changes from 70° F to 110° F expands only .00306 in./ft. from the low to high temperature. Multiplied by 300 ft., however, the total axial expansion is 300 ft. x .00306 in./ft., or .918 in.

In instances of this nature, rollers will be used, but the pipe covering protection saddles will not be required.

For economy in the support of low pressure, low temperature systems, and long outdoor transmission lines, hanger spans may be based on the allowable total stresses of the pipe and the amount of allowable deflection between supports.

In steam lines with long spans the deflection caused by the weight of the pipe may be large enough to cause an accumulation of condensate at the low points of the line. Water lines, unless properly drained, can be damaged by freezing. These conditions can be avoided by erecting the line with a downward pitch in such a manner that succeeding supports are lower than the points of maximum deflection in preceding spans as shown in Figure 36.

The stresses indicated in the Chart on page 66 and the Chart on page 67 are bending stresses resulting from the weight of the pipe between supports. It should be realized that this stress must be considered with other stresses in the piping, such as those due to the pressure of the fluid within the pipe, the bending and torsional stresses resulting from thermal expansion, etc., in order to design the system for total allowable stress.



The stresses and deflections indicated in the Charts on pages 66, 67 and 68 are based on a single span of pipe with free ends, and make no allowances for concentrated loads of valves, flanges, etc., between hangers.

The stress and deflection values shown in the Charts on pages 66, 67 and 68 are based on a free end beam formula and reflect a conservative analysis of the piping. Actually, the pipe line is a continuous structure partially restrained by the pipe supports, and the true stress and deflection values lie between those calculated for the free end beam and a fully restrained structure.

The deflections and bending stress values indicated represent safe values for any schedule pipe from Sch. 10 to XS pipe.

For fluids other than water, the bending stress can be found by first finding the added stress caused by water from the Charts on pages 68 and 69 and multiplying by the specific gravity of the fluid. Add this to the stress value of the pipe empty.

For lines which are thickly insulated, find the deflection or bending stress resulting from the weight of pipe bare and multiply by a ratio of the weight of pipe per foot plus insulation to the weight of bare pipe per foot. To illustrate the use of the deflection and stress charts, consider the following examples:

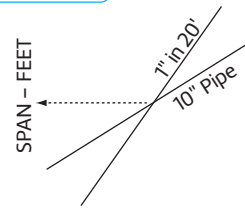
#### Problem:

**Find:** The maximum economical hanger spacing for a 10 in. non-insulated steam transmission line, 1,200 ft. long, which will provide sufficient drainage with minimum deflection within an allowable bending stress limit of 10,000 psi. The maximum difference in elevations of the ends of the line is 5ft.

#### Solution:

$$\text{Maximum Slope} = \frac{(5 \text{ ft.} \times 12 \text{ in./ft.})}{1,200 \text{ ft.}} = 1 \text{ in./20 ft.}$$

FIGURE 37 – Determination of Span



From the Chart on page 68 find the intersection of the Curve 1 in. in 20 ft., and 10 in. nominal pipe size. Read left to find the allowable pipe span of 40 ft. From the Chart on page 69, the bending stress for 10 in. pipe with a support span of 40 ft. is 3,250 psi, which is below the allowable 10,000 psi.

#### Answer:

Span = 40 ft .

#### Problem:

**Find:** The maximum economical spacing to provide sufficient drainage for an 8 in. water filled line 600 ft. long. The allowable bending stress is 6,000 psi, and the difference in elevations between the ends of the pipe line is 5 ft.

#### Solution:

$$\text{Maximum Slope} = \frac{(5 \text{ ft.} \times 12 \text{ in./ft.})}{600 \text{ ft.}} = 1 \text{ in./10}$$

From the Chart on page 68, find the intersection of the curve 1 in. in 10 ft. and 8 in. pipe, and read left to a span of 43 ft. From the Chart on page 69, for an 8 in. water filled line with a support span of 43 ft., the bending stress is 8,300 psi, which is greater than the allowable 6,000 psi. Therefore, the maximum span should be based on the allowable bending stress of 6,000 psi. Referring to the Chart on page 66, the maximum span for 8 in. pipe and an allowable bending stress of 6000 psi is 37 ft.

#### Answer:

Span = 37 ft

#### Problem:

**Find:** The maximum spacing and slope for a 6 in. water filled line where the allowable bending stress is 10,000 psi. The difference in the elevations of the ends of the system is not limited.

From the Chart on page 68, the maximum span for a 6 in. water filled line with an allowable bending stress of 10,000 psi is 42 ft.

On the Chart on page 69 read from the 42 foot span value to the 6in. pipe curve. Interpolating between the slope curves 1 in. in 10 ft. and 1 in. in 5 ft., read the slope 1 in. in 6 ft.

#### Answer:

Span = 42 ft

Pipe is sloped at 1 in. in 6 ft. (A difference in elevation of 7 in. between supports.)

## 1 Scope

This specification shall apply for the design and fabrication of all hangers, supports, anchors, and guides. Where piping design is such that exceptions to this specification are necessary, the particular system will be identified, and the exceptions clearly listed through an addendum which will be made a part of the specification.

## 2 Design

- a All supports and parts shall conform to the latest requirements of the ASME Code for Pressure Piping B31.1.0, and MSS Standard Practice SP-58, SP-69, SP-89 and SP-90 except as supplemented or modified by the requirements of this specification.
- b Designs generally accepted as exemplifying good engineering practice, using stock or production parts, shall be utilized wherever possible.
- c Accurate weight balance calculations shall be made to determine the required supporting force at each hanger location and the pipe weight load at each equipment connection.
- d Pipe hangers shall be capable of supporting the pipe in all conditions of operation. They shall allow free expansion and contraction of the piping, and prevent excessive stress resulting from transferred weight being introduced into the or connected equipment.
- e Wherever possible, pipe attachments for horizontal piping shall be pipe clamps.
- f For critical high-temperature piping, at hanger locations where the vertical movement of the piping is  $\frac{1}{2}$  in. or more, or where it is necessary to avoid the transfer of load to adjacent hangers or connected equipment, pipe hangers shall be an approved constant support design, as Anvil Figure 80-V and Figure 81-H where transfer of load to adjacent hangers or equipment is not critical, and where the vertical movement of the piping is less than  $\frac{1}{2}$  in., variable spring hangers may be used, provided the variation in supporting effect does not exceed 25% of the calculated piping load through its total vertical travel.
- g The total travel for constant support hangers will be equal to actual travel plus 20%. In no case will the difference between actual and total travel be less than 1 in. The constant support hanger will have travel scales on both sides of the support frame to accommodate inspections.
- h Each constant support hanger should be individually calibrated before shipment to support the exact loads specified. The calibration record of each constant support shall be maintained for a period of 20 years to assist the customer in any redesign of the piping system. Witness marks shall be stamped on the Load Adjustment Scale to establish factory calibration reference point.
- i In addition to the requirements of ASTM A-125 all alloy springs shall be shot peened and examined by magnetic particle. The spring rate tolerance shall be  $\pm 5\%$ . All three critical parameters (free height, spring rate and loaded height) of spring coils must be purchased with a C.M.T.R. and be of domestic manufacturer.
- j Constant supports should have a wide range of load adjustability. No less than 10% of this adjustability should be provided either side of the calibrated load for plus or minus field adjustment. Load adjustment scale shall be provided to aid the field in accurate adjustment of loads. Additionally, the constant support should be designed so that the load adjustments can be made without use of special tools and not have an impact on the travel capabilities of the supports.
- k Constant supports shall be furnished with travel stops which shall prevent upward and downward movement of the hanger. The travel stops will be factory installed so that the hanger level is at the "cold" position. The travel stops will be of such design as to permit future re-engagement, even in the event the lever is at a position other than "cold", without having to make hanger adjustments.
- l For non-critical, low temperature systems, where vertical movements up to 2 in. are anticipated, an approved pre-compressed variable spring design similar to Anvil Figure B268 may be used. Where the vertical movement is greater than 2 in., a variable spring hanger similar to Anvil Figure 98 may be used. Where movements are of a small magnitude, spring hangers similar to Anvil Figure 82 may be used.
- m Each variable spring shall be individually calibrated at the factory and furnished with travel stops. Spring coils must be square to within  $1^\circ$  to insure proper alignment. Each spring coil must be purchased with a C.M.T.R. and be of domestic manufacture.
- n All rigid rod hangers shall provide a means of vertical adjustment after erection.
- o Where the piping system is subject to shock loads, such as seismic disturbances or thrusts imposed by the actuation of safety valves, hanger design shall include provisions for rigid restraints or shock absorbing devices of approved design, such as Anvil Figure 200 shock and sway suppressor.
- p Selection of vibration control devices shall not be part of the standard hanger contract. If vibration is encountered after the piping system is in operation, appropriate vibration control equipment shall be installed.
- q Hanger rods shall be subject to tensile loading only (see Table III, Page 38). At hanger locations where lateral or axial movement is anticipated, suitable linkage shall be provided to permit swing.
- r Where horizontal piping movements are greater than  $\frac{1}{2}$  in. and where as the hanger rod angularity from the vertical is less than or equal to  $4^\circ$  from the cold to hot position of the pipe, the hanger pipe and structural attachments shall be offset in such manner that the rod is vertical in the hot position. When the hanger rod angularity is greater than  $4^\circ$  from vertical, then structural attachment will be offset so that at no point will the rod angularity exceed  $4^\circ$  from vertical.
- s Hangers shall be spaced in accordance with Tables I and II (Shown to the right).
- t Where practical, riser piping shall be supported independently of the connected horizontal piping. Pipe support attachments to the riser piping shall be riser clamp lugs. Welded attachments shall be of material comparable to that of the pipe, and designed in accordance with governing codes.



asc-es.com

Building connections that last™

- U** Supports, guides, and anchors shall be so designed that excessive heat will not be transmitted to the building steel. The temperature of supporting parts shall be based on a temperature gradient of 100°F per 1 in. distance from the outside surface of the pipe.
- V** Hanger components shall not be used for purposes other than for which they were designed. They shall not be used for rigging and erection purposes.
- W** **Hydraulic Snubbers** — The hydraulic units shall have a temperature stable control valve. The valve shall provide a locking and bleed rate velocity that provides for tamper proof settings. The fluid system shall utilize a silicone fluid with proven compatible seals made of approved compounds. The reservoir shall provide a fluid level indicator for exact reading of reservoir fluid level in any snubber orientation.

The valve device shall offer a minimum amount of resistance to thermal movement. Any shock force shall cause the suppressor valve to close. With the suppressor valve closed the fluid flow shall essentially stop, thereby causing the unit to resist and absorb the disturbing forces. After the disturbing forces subside the suppressor valve shall open again to allow free thermal movement of the piping. The suppressor shall have a means of regulating the amount of movement under shock conditions up to the design load for faulted conditions without release of fluid. The suppressor design shall include a fluid bleed system to assure continued free thermal movement after the shock force subsides. The suppressor shall have a hard surfaced, corrosion resistant piston rod supported by a bronze rod bushing. The assembly shall have self-aligning lubricated bushings and shall be designed so that it is capable of exerting the required force in tension and compression, utilizing the distance.

- Y** **Paint** — Variable spring and constant support units will be furnished prime painted. All other material will receive one shop coat of a red chromate primer meeting the requirements of Federal Specification TTP-636. For corrosive conditions, hangers will be galvanized or painted with Garbo-Zinc #11.

## 1 Hanger Design Service

Hangers for piping 2½ in. and larger, and all spring support assemblies, shall be completely engineered.

- a** Engineered hanger assemblies shall be detailed on 8½ in. x 11 in. sheets. Each sketch will include a location plan showing the location of the hanger in relation to columns of equipment. Each sketch will include an exact bill of material for the component parts making up each assembly.
- b** Each engineered hanger assembly will be individually bundled and tagged as far as practical, ready for installation. Hanger material for piping 2 in. and smaller shall be shipped as loose material, identified by piping system only. A piping drawing marked with approximate hanger locations and types, and hanger sketches showing typical support arrangements will be furnished.
- c** Hanger inspections shall be performed in accordance with MSS-SP89 (Section 7.7) and ASME B31.1 (Appendix V)

Table I Maximum Horizontal Spacing Between Pipe Supports for Standard Weight Steel Pipe

Nom. Pipe Size (In.)	½	¾	1	1½	2	2½	3	3½	4	5	6	8	10	12	14	16	18	20	24
Max Span, Water Serv. (ft.) -->	7	7	7	9	10	11	12	13	14	16	17	19	22	23	24	27	28	30	32
Max Span, Vapor Serv. (ft.) -->	8	9	9	12	13	14	15	16	17	19	21	24	26	30	32	35	37	39	42

Table II Maximum Horizontal Spacing Between Copper Tubing Supports

Nom. Pipe Size (In.)	½	¾	1	1½	2	2½	3	3½	4
Max Span, Water Serv. (ft.) -->	7	7	7	9	10	11	12	13	14
Max Span, Vapor Serv. (ft.) -->	8	9	9	12	13	14	15	16	17



## Field Engineering Walkdowns

Critical piping systems shall be observed visually, as frequently as deemed necessary, and any unusual conditions shall be brought to the attention of the operating company. Only qualified and trained personnel shall be utilized for these observations. Observations shall include determination of interferences with or from other piping or equipment, vibrations, and general condition of the supports, hangers, guides, anchors, supplementary steel, and attachments, etc.

Hanger position scale readings of variable and constant support hangers shall be determined periodically. It is recommended that readings be obtained while the piping is in its fully hot position, and if practical, when the system is reasonably cool or cold sometime during the year as permitted by plant operation. Pipe temperature at time of reading hangers shall be recorded.

Variable and constant support hangers, vibration control devices, shock suppressors, dampeners, slide supports and rigid rod hangers shall be maintained in accordance with the limits specified by the manufacturers and designers. Maintenance of these items shall include, but not necessarily be limited to, cleaning, lubrication and corrosion protection.

Pipe location readings and travel scale readings of variable and constant support hangers shall be recorded on permanent log sheets in such a manner that will be simple to interpret. Records of settings of all hangers shall be made before the original commercial operation of the plant and again after startup.

After visually observing piping, hangers, and supports, repairs and/or modifications are to be carried out by qualified maintenance personnel for all of the following items:

- a Excessively corroded hangers and other support components
- b Broken springs or any hardware item which is part of the complete hanger or support assembly
- c Excessive piping vibration; valve operator shaking or movements
- d Piping interferences
- e Excessive piping deflection which may require the installation of spring units having a greater travel range
- f Pipe sagging which may require hanger adjustment or the reanalysis and redesign of the support system
- g Hanger unit riding at either the top or the bottom of the available travel
- h Need for adjustment of hanger load carrying capacity
- i Need for adjustments of hanger rods or turnbuckle for compensation of elevation changes
- j Loose or broken anchors
- k Inadequate clearances at guides
- l Inadequate safety valve vent clearances at outlet of safety valves

- m Any failed or deformed hanger, guide, U-bolt, anchor, snubber, or shock absorber, slide support, dampener, or supporting steel
- n Leaks at flanges, valve bonnets and valve stems
- o Excessively corroded valves
- p Defective traps, separators, strainers, silencers, flexible hose, flexible fittings, and water level gage glasses
- q Unacceptable movements in expansion joints

The use of photographs can be an important tool in recording piping systems, hangers and supports. These can be stored with the other records and are beneficial for future reference and will establish a system history for future reference. Each plant should maintain and file the following documentation that exists for each unit:

- a Current piping drawings
- b Construction isometrics
- c Pipeline specifications covering material, outside diameter, and wall thickness
- d Flow diagrams
- e Support drawings
- f Support setting charts
- g Records of any piping system modifications



asc-es.com

Building connections that last™

## Nuclear Pipe Supports

Nuclear pipe support design has evolved from a relatively simple design-by-rule approach to a complex design-by-analysis approach. Pipe support design has presented some major challenges for the nuclear power industry. The ASME Boiler and Pressure Vessel Code, Section III, Division 1, Subsection NF, "Component Supports", contains very detailed requirements for nuclear pipe supports. The NF Code contains requirements for material design, fabrication and installation, examination, nameplates, stamping, and reports. The principal differences between nuclear and non-nuclear pipe supports lie in the more sophisticated and demanding design, analysis, additional non-destructive examination (NDE), quality assurance, and Code inspection and stamping. However, the type of pipe supports and materials used for nuclear pipe supports are essentially the same as those used for nonnuclear.

The design of nuclear pipe supports is dependent upon a piping analysis which provides the appropriate support loading and displacements. The pipe support designer/analyst must be aware of specific assumptions that the piping analyst used in performing the piping analysis. Typical assumptions are:

- 1 No excessive support mass on pipe;
- 2 Support is provided in directions shown with type support shown;
- 3 Support is sufficiently rigid to permit decoupling of the analysis of the support from the pipe;
- 4 Support allows for essentially unrestricted movement in the unsupported direction.

## Seismic Supports

The following is for reference only. Refer to MSS-SP127 for detailed requirements). Seismology and its effect on building structures, components and attachments affect almost every building code and standard. Increasingly, codes and standards are requiring seismic restraints in critical areas. There are several codes and standards across the country that contain entire sections devoted to seismic restraints and bracing. Some of the more common codes are the Uniform Building Code 1991 and the 1991 California Building Standard Code (CAC Title 24, Part II).

The progressive CAC Title 24 states in Section 2330 (a):

"Every building or structure and every portion thereof, including the nonstructural components, shall be designed and constructed to resist stresses and limit deflections calculated on the basis of dynamic analysis or equivalent static lateral forces analysis ..."

It continues in Section 2336 (a)

"Parts and portions of structure and their attachments, permanent nonstructural components and their attachments, and the attachments for permanent equipment supported by a structure shall be designed to resist the total design lateral seismic force,  $F_p$ , given by the following formula:

$F_p = Z \times I \times C_p \times W_p$ , Where:

$F_p$  = Total Design Lateral Seismic Force.

$Z$  = Seismic Zone Factor, Numerical Coefficient as shown in Table 23-1 and derived from Seismic Zones Map on Page 27.

$I$  = Importance Factor, as shown on Table No. 23-L and derived from Occupancy Categories shown on Table No. 23-K.

$C_p$  = Horizontal Force Factor ("... conduit, ductwork and piping ..." has a  $C_p$  of 0.75 per the CAC Title 24 and a  $C_p$  of 0.45 per the 1991 Uniform Building Code).

Nuclear pipe supports are designed to the same loadings that fossil power plants experience, i.e., thermal, deadweight, thermal equipment displacement loadings, and operating loadings, including turbine trip, rapid valve closure, etc. In addition to these normal loadings, nuclear power plants require detailed analysis for seismic loadings on the piping system. This detailed seismic requirement results in the significant difference between the design of nuclear pipe support versus a conventional power plant.

The seismic requirement resulted in piping systems which were considerably stiffer when compared to similar systems without seismic requirements. This was the direct result of providing additional lateral and vertical restraints to resist the seismic loadings on the piping system. The additional restraints reduced seismic stresses, but resulted in increased thermal stresses. To minimize this impact, pipe snubbers were utilized in piping systems. Snubbers are devices which are essentially only active during an earthquake or other dynamic event and offer little resistance to the slow pipe movement resulting from thermal growth. Although snubbers have seen limited use in conventional plants, their primary use was in nuclear facilities. Since the use of snubbers requires a significant amount of functional testing and inspection, their use has been considerably reduced. In addition, most nuclear plants have initiated programs to eliminate as many snubbers as possible. Although the use of snubbers should generally be avoided, they may, in certain circumstances, present the most simple and cost effective solution.

$W_p$  = Weight of Element or Component (Weight of pipe, ductwork and conduit)

The following conduit, ductwork and piping do NOT require bracing per CAC Title 24, Part II: Table No. 23-P, note 12.

- a Gas piping less than 1 in. diameter.
- b Piping in boiler and mechanical equipment rooms less than 1.25 in. inside diameter.
- c All piping less than 2.5 in. inside diameter.
- d All piping suspended by individual hangers 12 in. or less in length from the top of pipe to the bottom of the support for the hanger.
- e All electrical conduit less than 2.5 in. inside diameter.
- f All rectangular air-handling ducts less than 6 sq. ft. in cross-sectional area.
- g All round air handling ducts less than 28 in. diameter.
- h All ducts suspended by hangers 12 in. or less in length from the top of the duct to the bottom of the support for the hanger.



## Table 23K Occupancy Categories

**(I) Essential Facilities** (Essential facilities are those structures which are necessary for the emergency operations subsequent to a natural disaster.)

- Hospitals and other medical facilities having surgery and emergency treatment areas.
- Fire, Sheriff and Police Stations
- Municipal, county and state government disaster operation and communication centers deemed vital in emergencies.
- Tanks of other structures containing, housing or supporting water or other fire-suppression materials or equipment required for the protection of essential or hazardous facilities, or special occupancy structures.
- Emergency vehicle shelters and garages.
- Standby power-generating equipment for essential facilities.

**(II) Hazardous Facilities**

- Structures housing, supporting or containing sufficient quantities of toxic or explosive substances to be dangerous to the safety of general public if released.

**(III) Special Occupancy Structure**

- Covered structures whose primary occupancy is public assembly - capacity  $\geq$  300 persons.
- Buildings for schools through secondary or day-care centers - capacity  $\geq$  250 students.
- Buildings for colleges or adult education schools - capacity  $\geq$  500 students.
- Medical facilities with 50 or more resident incapacitated patients, not included above.
- Jails and detention facilities.
- All structures with occupancy  $\geq$  5,000 persons.
- Structures and equipment in power-generating stations and other public utility facilities not included above, and required for continued operation.

**(IV) Standard Occupancy Structure**

- All structures having occupancies or functions not listed above.

**Table 23-L Earthquake Importance Factor (I),  
Based on Occupancy Category**

Occupancy Category	1991 Uniform Building Code	CAC Title 24
I. Essential Facility	1.25	1.50
II. Hazardous Facilities	1.25	1.50
III. Special Occupancy Structures	1.00	1.15
IV. Standard Occupancy Structures	1.00	1.00

**Table 23-I Seismic Zone Factor "Z"**

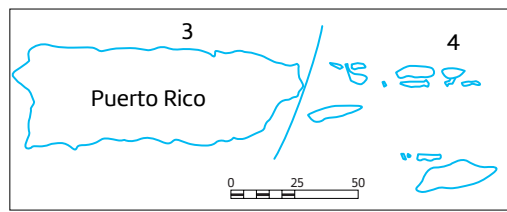
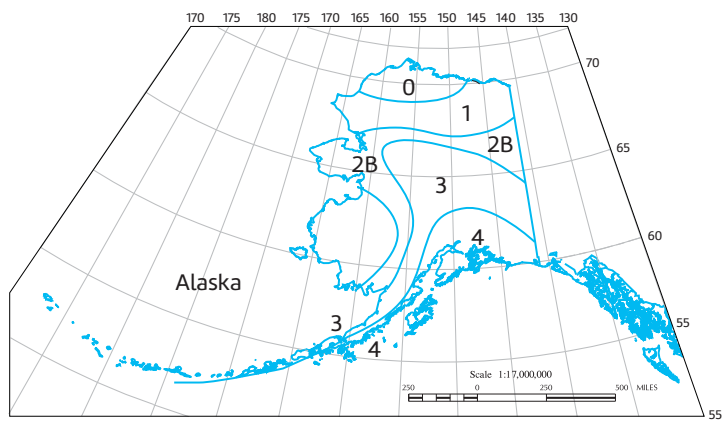
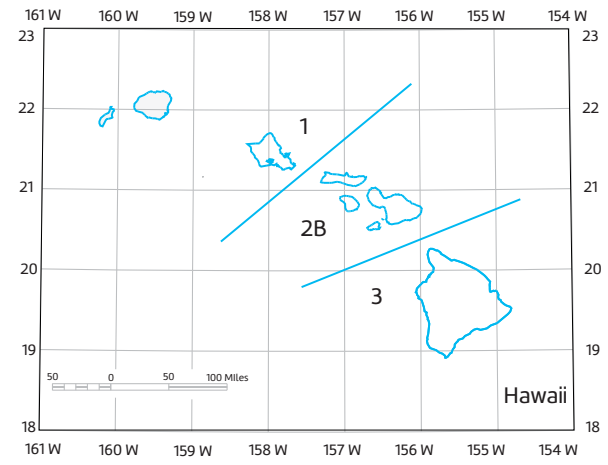
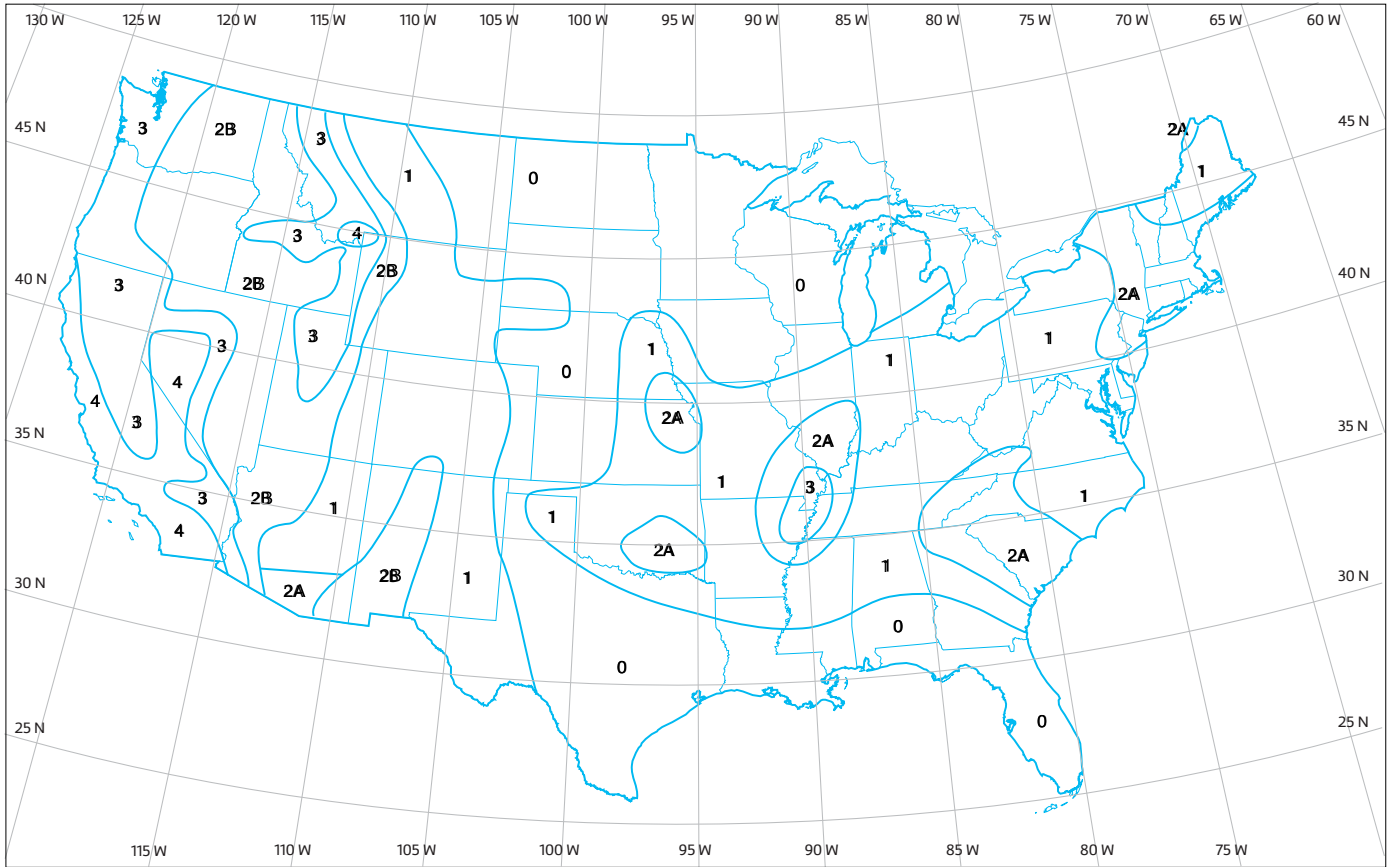
Zone ---->	1	2A	28	3	4
Zone Factor ---->	0.075	0.15	0.20	0.30	0.40

Refer to zone map on the following page for general information purposes, or visit <http://www.eqhazmaps.usgs.gov> for current seismic zone information.



asc-es.com

Building connections that last™



The maps shown above are for general information purposes, please visit <http://www.earthquake.usgs.gov/hazmaps/> for current seismic zone information.

1994 Uniform Building Code zone map. Zones are identified by the numbers from 0 to 4.

Seismic zone factors are assigned to each zone; Zone 0 = 0, Zone 1 = 0.075, Zone 2A = 0.15, Zone 2B = 0.20, Zone 3 = 0.3, and Zone 4 = 0.4.

Each zone also has specific structural detailing requirements.



## Pipe Supports – Grooved Piping

When designing the hangers, supports and anchors for a grooved end pipe system, the piping designer must consider certain unique characteristics of the grooved type coupling in addition to many universal pipe hanger and support design factors. As with any pipe system, the hanger or support system must provide for

- 1 The weight of the pipe, couplings, fluid and pipe system components;
- 2 Reduce stresses at pipe joints; and
- 3 Permit required pipe system movement to relieve stress.  
The following special factors should be considered when designing hangers and supports for a grooved end pipe system.

## Pipe Hanger Spacing

The following charts show the maximum span between pipe hangers for straight runs of standard weight steel pipe filled with water or other similar fluids.

Do not use these values where critical span calculations are made or where there are concentrated loads between supports.

### Pipe Hanger Spacing for Straight Runs without Concentrated Loads and Where Full Linear Movement IS NOT Required

Nominal Pipe Size Range	Max. Span Between Hangers
¾"-1"	7'
1¼"-2"	10'
2½"-4"	12'
5"-8"	14'
10"-12"	16'
14"-16"	18'
18"-24"	20'

### Pipe Hanger Spacing for Straight Runs without Concentrated Loads and Where Full Linear Movement IS Required

Nominal Pipe Size Range	Pipe Length in Feet									
	*Average Hangers per Pipe Length (Evenly Spaced)									
	7'	10'	12'	15'	20'	22'	25'	30'	35'	40'
¾"-1"	1	2	2	2	3	3	4	4	5	6
1¼"-2"	1	2	2	2	3	3	4	4	5	6
2½"-4"	1	2	2	2	3	3	4	4	5	6
5"-8"	1	2	2	2	3	3	4	4	5	6
10"-12"	1	2	2	2	3	3	4	4	5	6
14"-16"	1	2	2	2	3	3	4	4	5	6
18"-24"	1	2	2	2	3	3	4	4	5	6

\* No pipe length should be left unsupported between any two couplings.



asc-es.com

Building connections that last™

## Coupling Flexibility

The grooved coupling's capability to allow angular and rotational movement within the coupling joint must be considered when deciding hanger and support locations. Spring hangers and supports providing for movement in more than one plane are often used to allow the pipe system to move without introducing additional stress into the pipe system.

FIGURE 38 – Sag Due to Flexibility

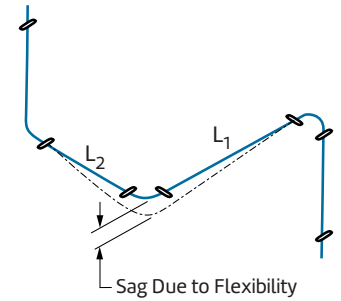
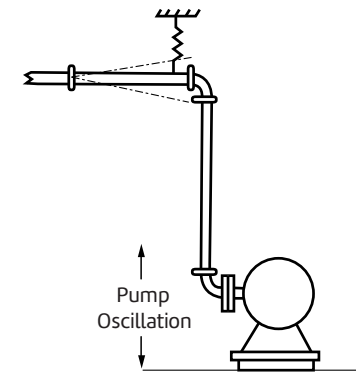


Figure 38 demonstrates the need for each pipe length in a grooved system to be supported. The sag due to the flexibility of the Gruvlok joint could be eliminated with the proper positioning of hangers on both "L1" and "L2".

Figure 39 illustrates the effect of pump oscillation on a piping system.

A spring hanger should be used to support the pipe section and also respond to the induced vibrations. The couplings in the horizontal run above the riser, should accommodate the deflection without transmitting bending stresses through the pipe system.

FIGURE 39 – Pump Oscillation



## Pressure Thrusts

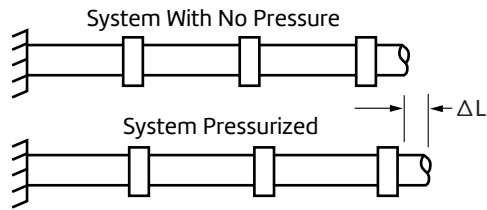
Gruvlok couplings react to the application of system pressure and restrain the pipe ends from separation due to the pressure force. However, the coupling joint may not be in the self-restraining configuration prior to the application of system pressure. The Gruvlok coupling does not restrain adjacent pipe sections from separation due to pressure forces until the coupling key sections engage the groove walls.

Random coupling joint installation will produce installed coupling conditions ranging from pipe ends fully butted to fully separated to the maximum available gap. Thus, only after system pressurization will the self-restraining function of the coupling be in effect.

The designer must account for the movement to be encountered when the system is pressurized and the joints are fully separated. Anchor and guide positions must be defined to direct the pipe joint movement such that it is not detrimental to the pipe system.

The effect of pressure thrust are shown in the following examples.

**FIGURE 40 – Pressure Thrust**



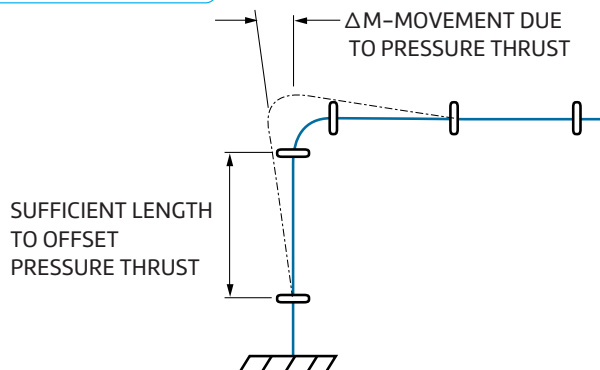
**Figure 40 –** The coupling joints have been installed butted or partially open. When pressurized the pipe ends in the coupling joints will separate to the maximum amount permitted by the coupling design.

The coupling key sections will make contact with the groove walls and restrain the pipe from further separation.

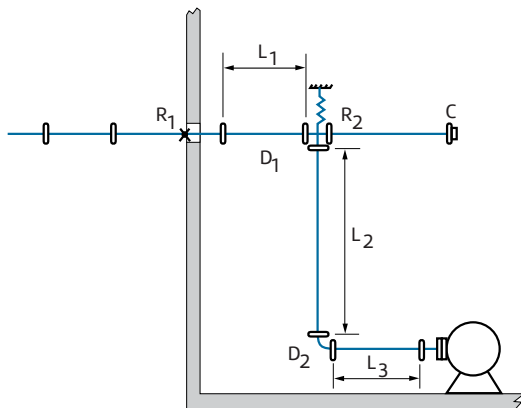
The movement at each coupling joint will add with all other joints and produce  $\Delta L$ .

**Figure 41 –** In the system shown here, the pipe will move and deflect at the elbow joint due to pressure thrust. The pipe designer must assure himself that the system has the capability of deflecting sufficiently to absorb this movement without introducing additional stresses into the pipe system. In the deflected condition shown, temperature increases would produce further expansion of the pipe system thus increasing the deflection.

**FIGURE 41 – Pressure Thrust**

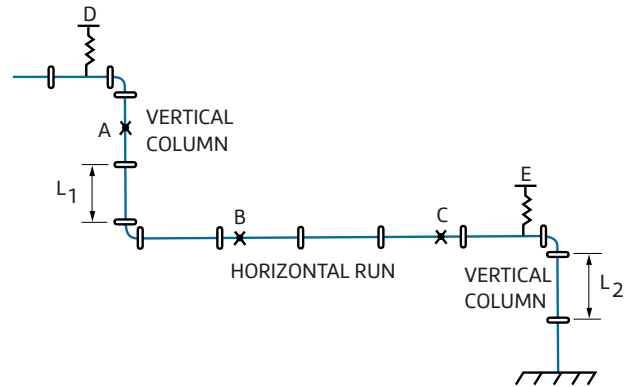


**FIGURE 42 – Pressure Thrust**



**Figure 42 –** To restrain this system provide a pressure thrust anchor at "R1" to resist the pressure thrust acting through the tee "D1" at the cap "C". Provide a hanger at Point "R2", or a base support at Point "D2" to support the vertical column. If the offsets L1, L2, and L3 are of adequate length to handle expected pipe movements, no additional anchoring is required. Thermal movement of the pipe system should also be considered, and intermediate anchors located as required, to direct the pipe movement so as to prevent introducing bending stresses into the system.

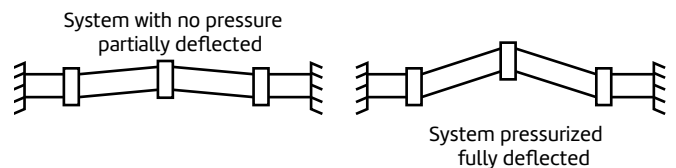
**FIGURE 43 – Lateral Restraint**



**Figure 43 –** Anchor at "A" to support weight of vertical water column. Use spring hanger at "D" and "E" to allow movement of vertical piping.

Anchors at "B" and "C" if offsets at L1 and L2 are insufficiently long to handle expected pipe movements.

**FIGURE 44 – Lateral Restraint**



**Figure 44 [Lateral Restraint] –** A grooved coupling joint installed in a partially deflected condition between anchor locations will deflect to its fully deflected condition when pressurized. Hangers and supports must be selected with consideration of the hanger's capability to provide lateral restraint.

Light duty hangers, while acceptable in many installations, may deflect against the application of lateral forces and result in "snaking" conditions of the pipe system.



## Riser Design

Risers assembled with Gruvlok couplings are generally installed in either of two ways. In the most common method, the pipe ends are butted together within the coupling joint. Note that when installing risers, the gasket is first placed onto the lower pipe and rolled back away from the pipe end prior to positioning the upper pipe. Anchoring of the riser may be done prior to pressurization with the pipe ends butted or while pressurized, when, due to pressure thrust, the pipe ends will be fully separated. An alternative method of riser installation is to place a metal spacer of a predetermined thickness, between the pipe ends when an additional length of pipe is added to the riser stack. The upper pipe length is anchored, the spacer removed and the coupling is then installed. This method creates a predetermined gap at each pipe joint which can be utilized in pipe systems where thermal movement is anticipated and in systems with rigid (threaded, welded, flanged) branch connections where shear forces due to pressure thrust could damage the rigid connections.

The following examples illustrate methods of installing commonly encountered riser designs.

### Risers without Branch Connections

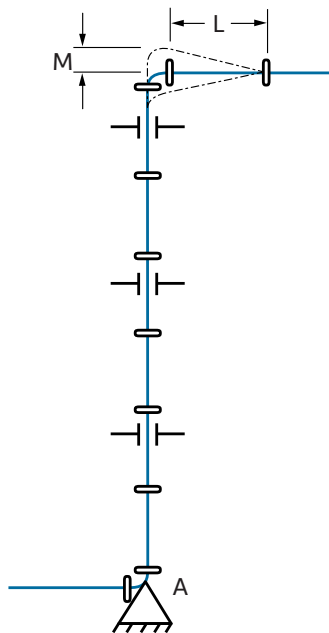
Install the riser with the pipe ends butted.

Locate an anchor at the base of the riser (A) to support the total weight of the pipe, couplings and fluid. Provide pipe guides on every other pipe length, as a minimum, to prevent possible deflection of the pipe line at the coupling joints as the riser expands due to pressure thrust or thermal growth. Note that no intermediate anchors are required.

When the system is pressurized the pipe stack will "grow" due to pressure thrust which causes maximum separation of pipe ends within the couplings. The maximum amount of stack growth can be predetermined (see Linear Movement).

In this example the pipe length "L" at the top of the riser must be long enough to permit sufficient deflection (see Angular Movement) to accommodate the total movement "M" from both pressure thrust and thermal gradients.

FIGURE 45 – Riser without Branch Connections



### Risers with Branch Connections

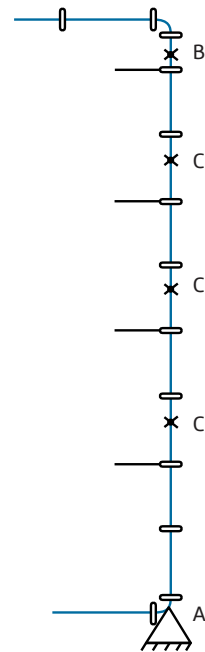
Install the riser with the predetermined gap method.

Anchor the pipe at or near the base with a pressure thrust anchor "A" capable of supporting the full pressure thrust, weight of pipe and the fluid column. Anchor at "B" with an anchor capable of withstanding full pressure thrust at the top of the riser plus weight of pipe column.

Place intermediate anchors "C" as shown, between anchors "A" and "B". Also place intermediate clamps at every other pipe length as a minimum.

When this system is pressurized, the pipe movement due to pressure thrust will be restrained and there will be no shear forces acting at the branch connections.

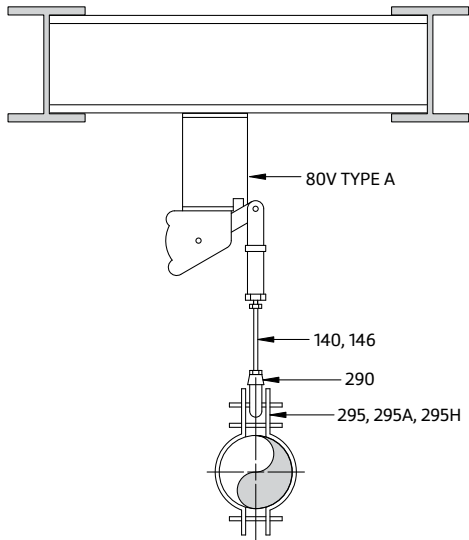
FIGURE 46 – Riser with Branch Connections



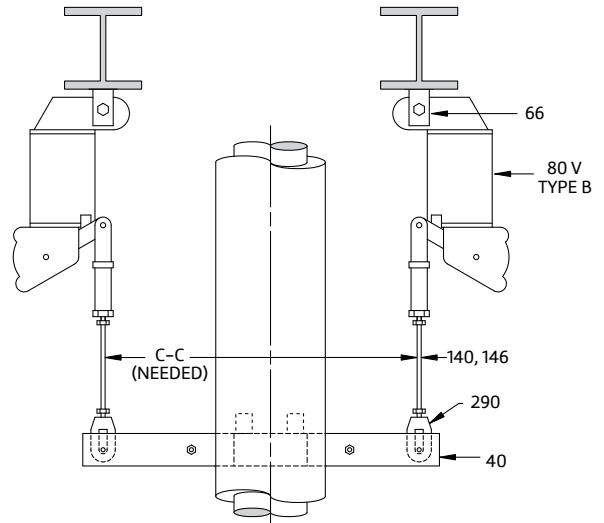
asc-es.com

Building connections that last™

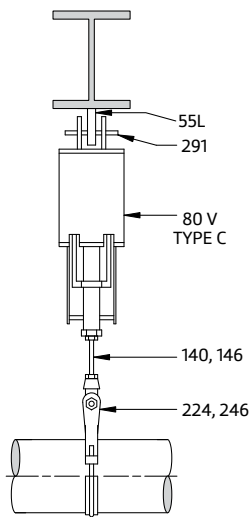
## Constant Hanger Assemblies



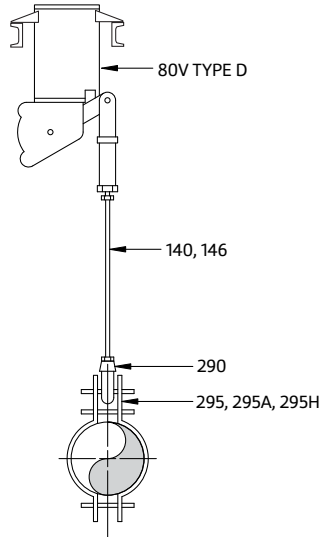
Fig\_80V\_Type\_A.DWG, .DXF, or .EPS



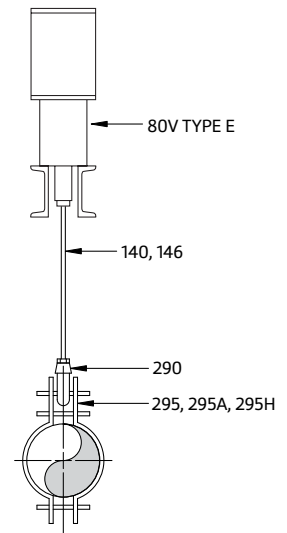
Fig\_80V\_Type\_B.DWG, .DXF, or .EPS



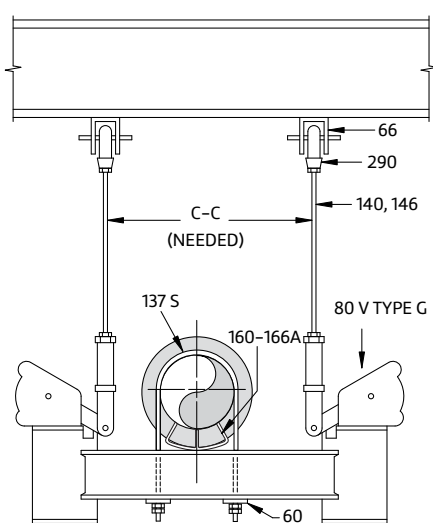
Fig\_80V\_Type\_C.DWG, .DXF, or .EPS



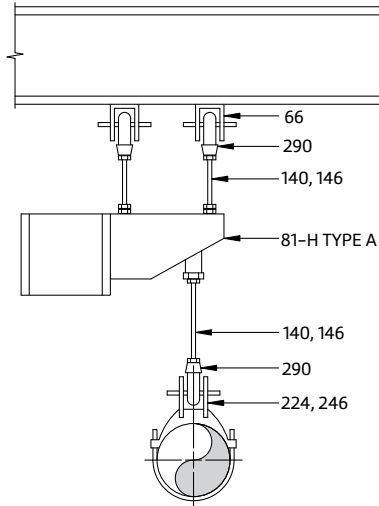
Fig\_80V\_Type\_D.DWG, .DXF, or .EPS



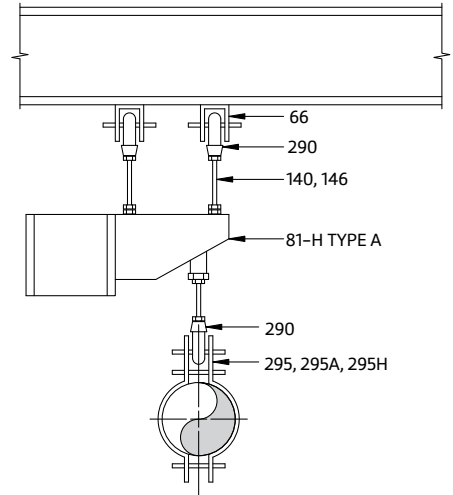
Fig\_80V\_Type\_E.DWG, .DXF, or .EPS



Fig\_80V\_Type\_G.DWG, .DXF, or .EPS



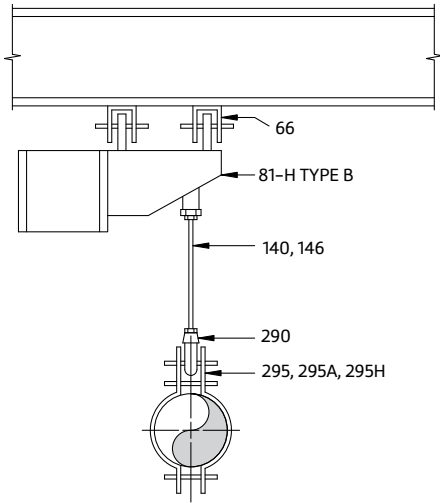
Fig\_81H\_Type\_A\_224.DWG, .DXF, or .EPS



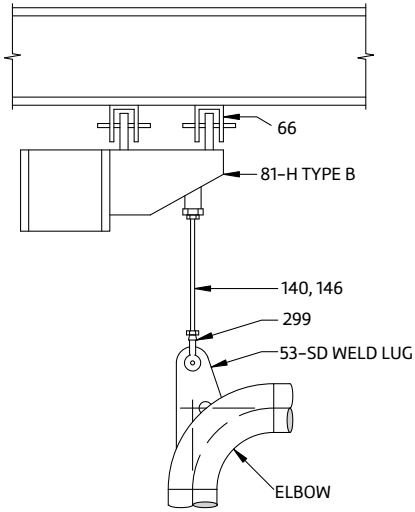
Fig\_81H\_Type\_A\_295.DWG, .DXF, or .EPS

Each of these drawings are available on the ASC website in CAD format. The file name at the bottom of each box refers to that CAD file.

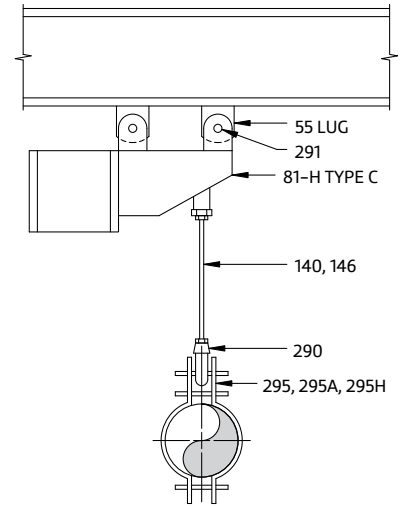
## Constant Hanger Assemblies (Cont.)



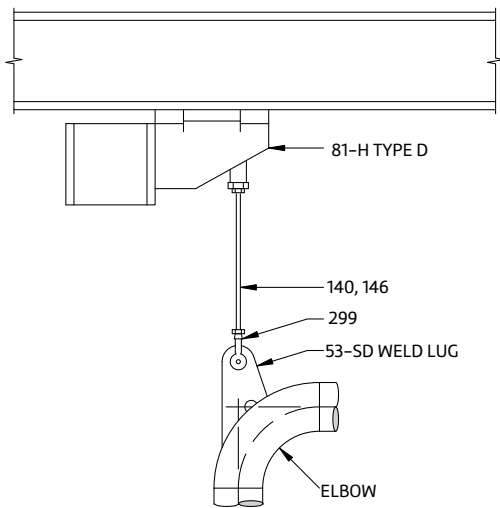
Fig\_81H\_Type\_B\_295 .DWG, .DXF, or .EPS



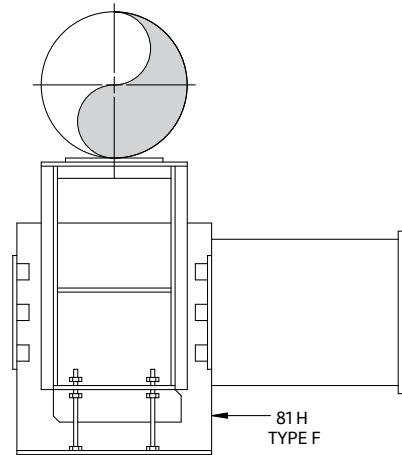
Fig\_81H\_Type\_B\_53\_SD .DWG, .DXF, or .EPS



Fig\_81H\_Type\_C .DWG, .DXF, or .EPS



Fig\_81H\_Type\_D .DWG, .DXF, or .EPS



Fig\_81H\_Type\_F .DWG, .DXF, or .EPS

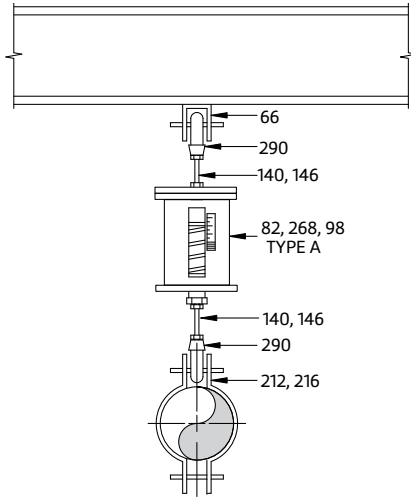
Each of these drawings are available on the ASC website in CAD format. The file name at the bottom of each box refers to that CAD file.



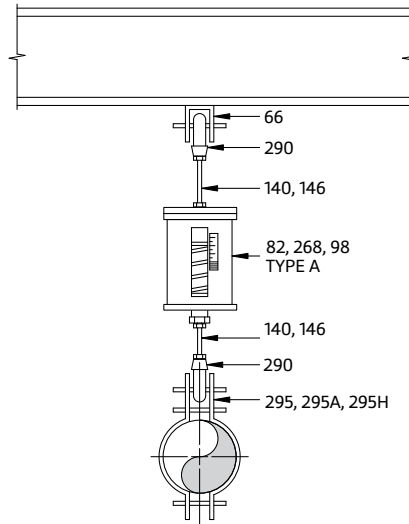
asc-es.com

Building connections that last™

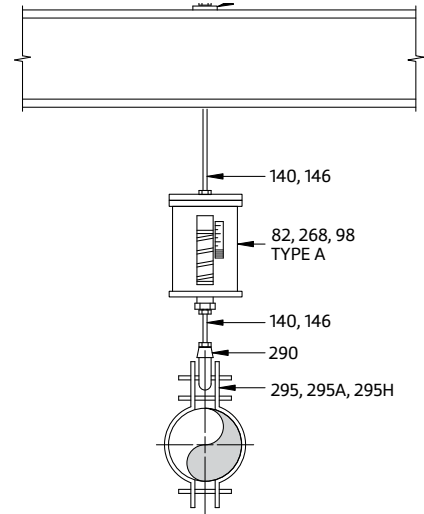
## Spring Hanger Assemblies



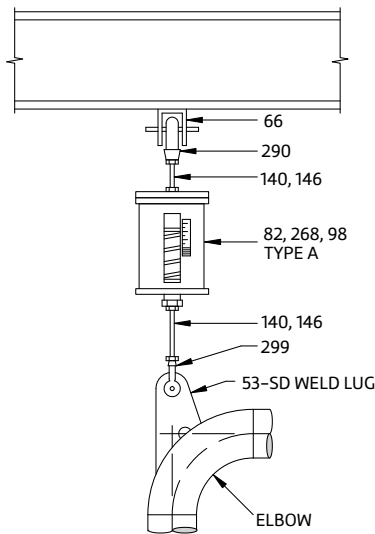
SH\_Type\_A\_212 .DWG, .DXF, or .EPS



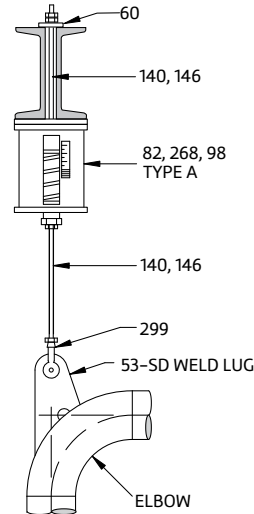
SH\_Type\_A\_295 .DWG, .DXF, or .EPS



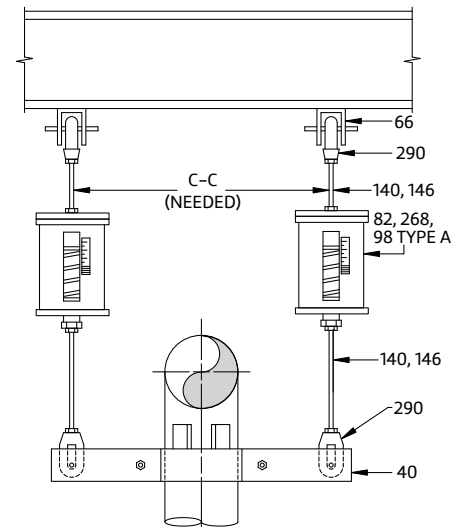
SH\_Type\_A\_60 .DWG, .DXF, or .EPS



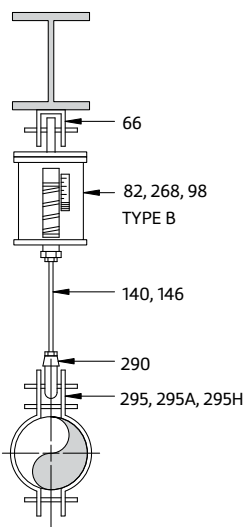
SH\_Type\_A\_53SD .DWG, .DXF, or .EPS



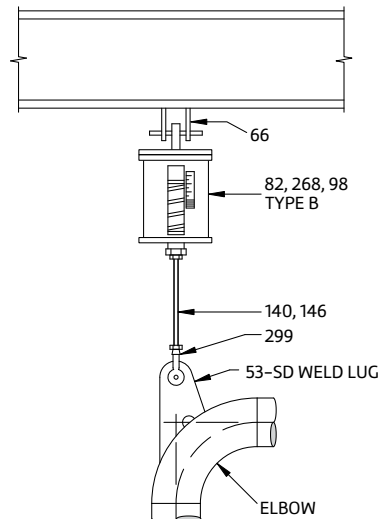
SH\_Type\_A\_53SD\_60 .DWG, .DXF, or .EPS



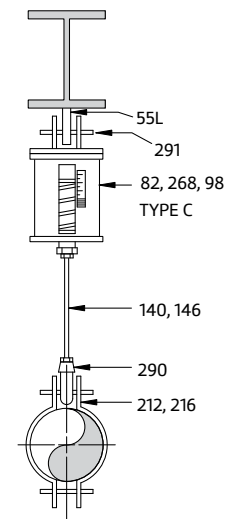
SH\_Type\_A\_Riser .DWG, .DXF, or .EPS



SH\_Type\_B\_295 .DWG, .DXF, or .EPS



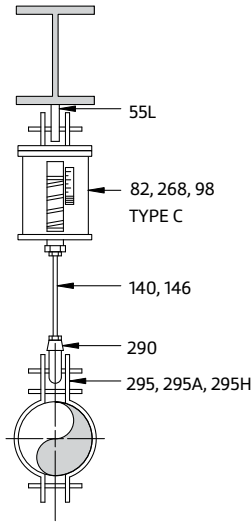
SH\_Type\_B\_53SD .DWG, .DXF, or .EPS



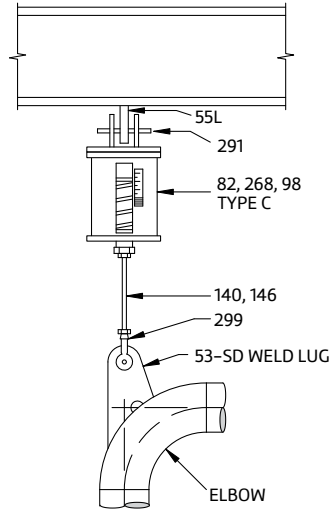
SH\_Type\_C\_212 .DWG, .DXF, or .EPS

Each of these drawings are available on the ASC website in CAD format. The file name at the bottom of each box refers to that CAD file.

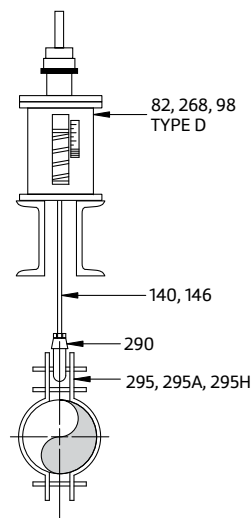
## Spring Hanger Assemblies (Cont.)



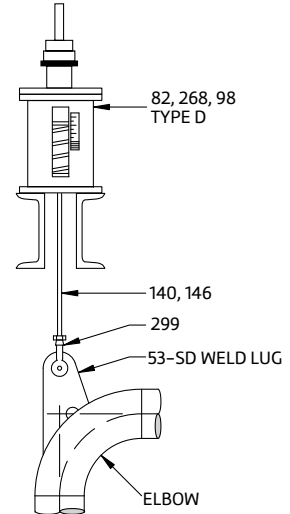
SH\_Type\_C\_295.DWG, .DXF, or .EPS



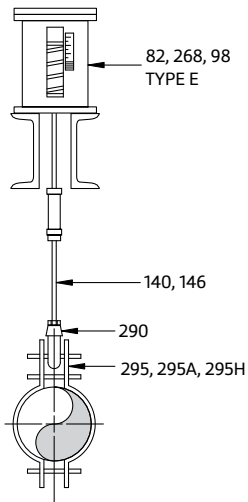
SH\_Type\_C\_53SD.DWG, .DXF, or .EPS



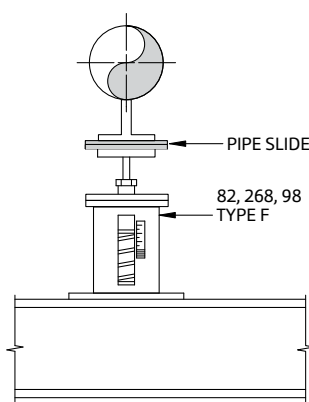
SH\_Type\_D\_295.DWG, .DXF, or .EPS



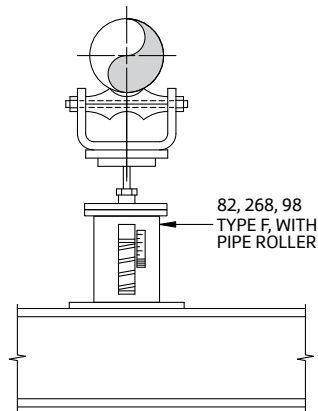
SH\_Type\_D\_53SD.DWG, .DXF, or .EPS



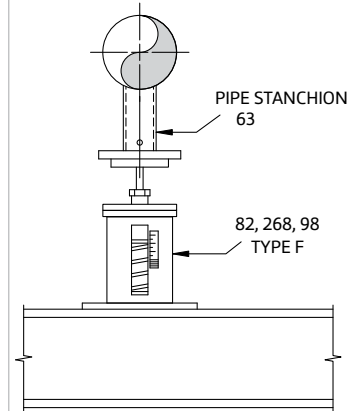
SH\_Type\_E.DWG, .DXF, or .EPS



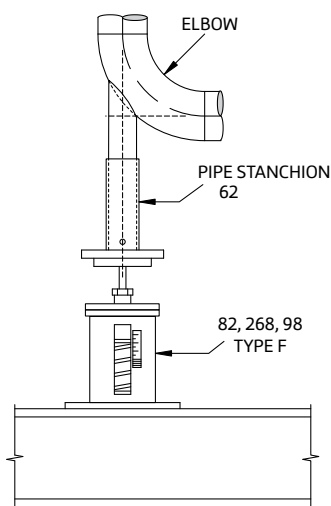
SH\_Type\_F-PipeSlide.DWG, .DXF, or .EPS



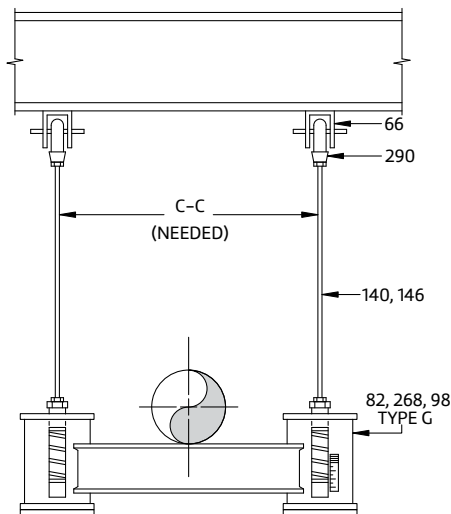
SH\_Type\_F-PipeRoller.DWG, .DXF, or .EPS



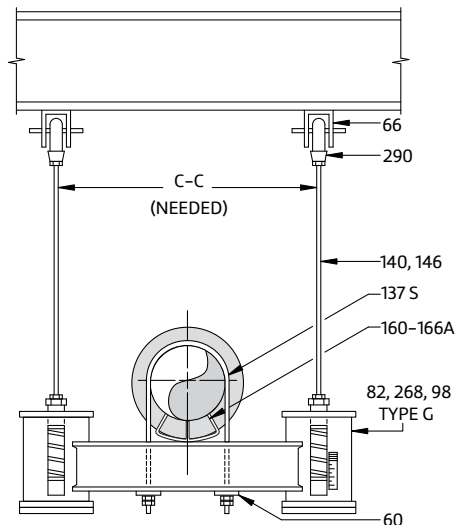
SH\_Type\_F\_63.DWG, .DXF, or .EPS



SH\_Type\_F\_62.DWG, .DXF, or .EPS



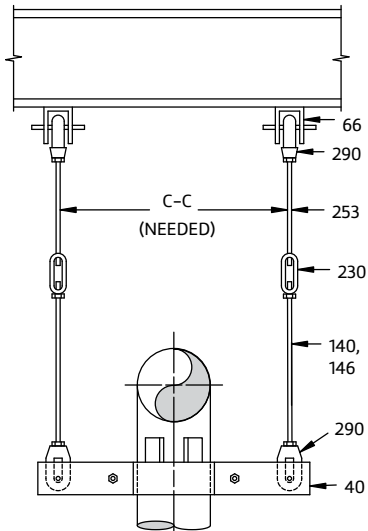
SH\_Type\_G.DWG, .DXF, or .EPS



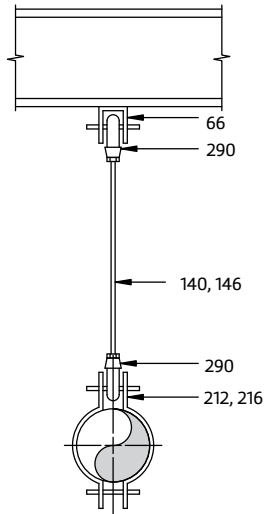
SH\_Type\_G\_160-137S.DWG, .DXF, or .EPS

Each of these drawings are available on the ASC website in CAD format. The file name at the bottom of each box refers to that CAD file.

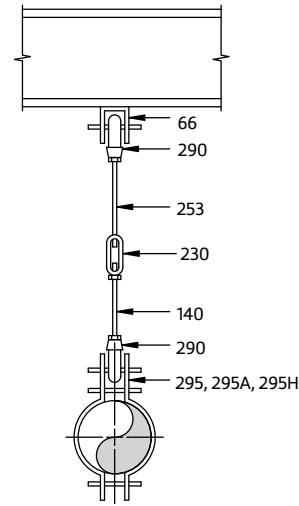
## Rigid Hanger Assemblies



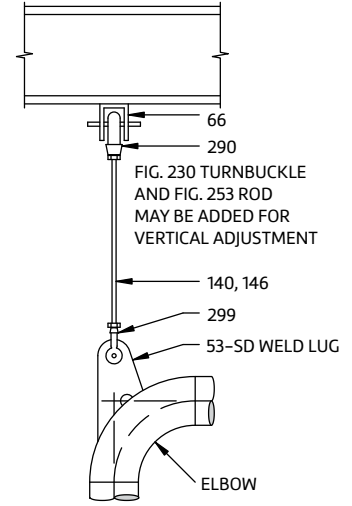
RH\_40\_290\_230\_Riser .DWG, .DXF, or .EPS



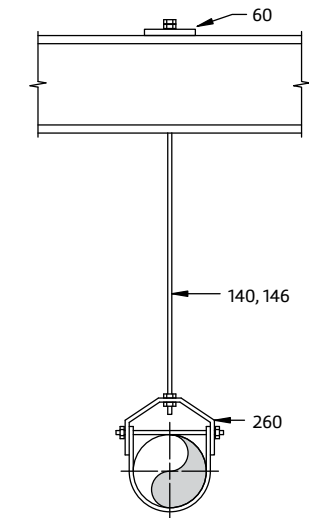
RH\_212\_290\_140\_66.DWG, .DXF, or .EPS



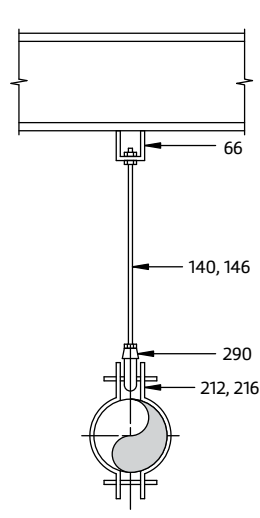
RH\_295\_290\_230.DWG, .DXF, or .EPS



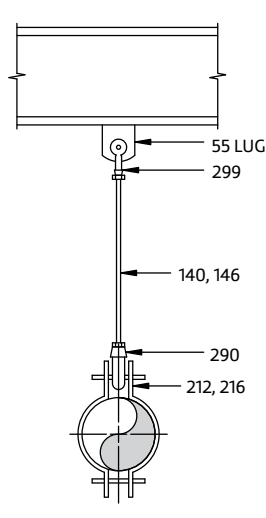
RH\_53SD\_299\_290.DWG, .DXF, or .EPS



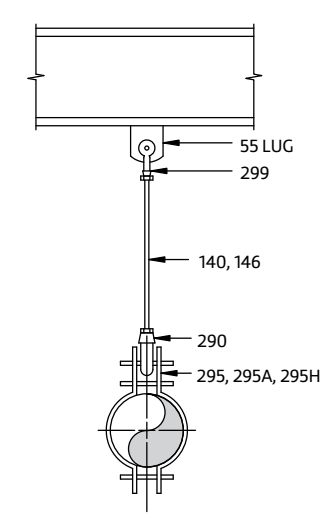
RH\_260\_140\_60.DWG, .DXF, or .EPS



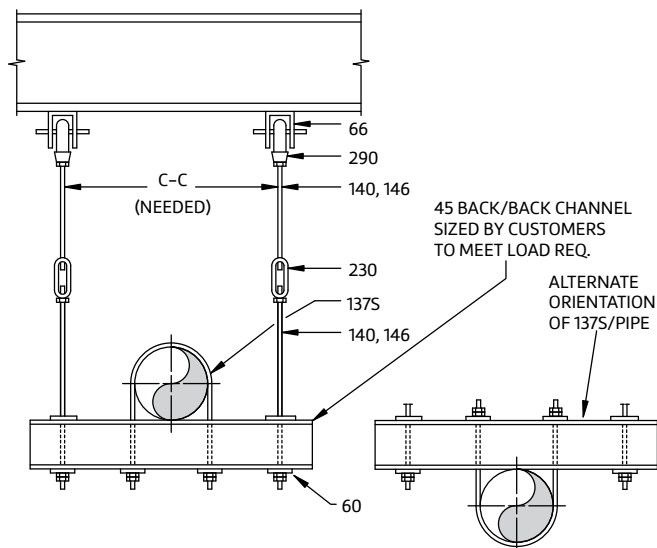
RH\_212\_290.DWG, .DXF, or .EPS



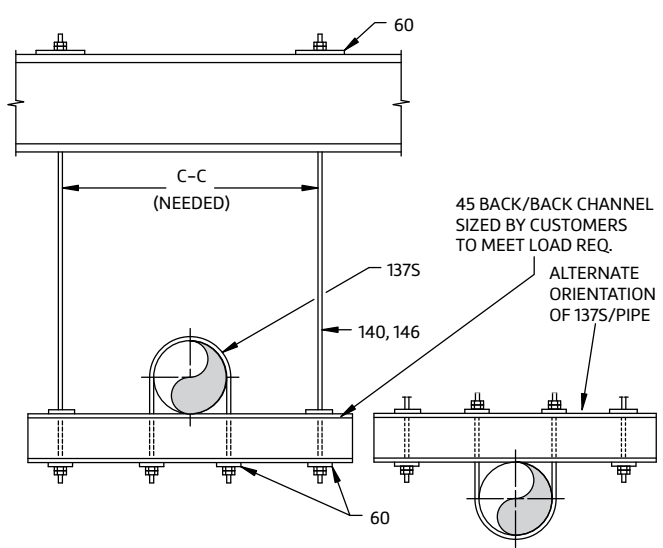
RH\_212\_290\_299\_55.DWG, .DXF, or .EPS



RH\_295\_290\_299\_55.DWG, .DXF, or .EPS



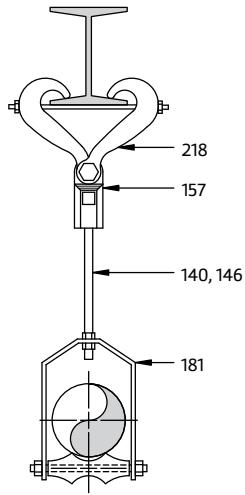
RH\_45\_137S\_66\_Trapeze .DWG, .DXF, or .EPS



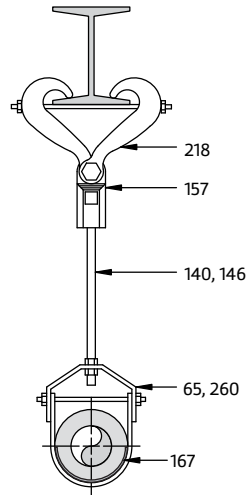
RH\_45\_137S\_60\_Trapeze .DWG, .DXF, or .EPS

Each of these drawings are available on the ASC website in CAD format. The file name at the bottom of each box refers to that CAD file.

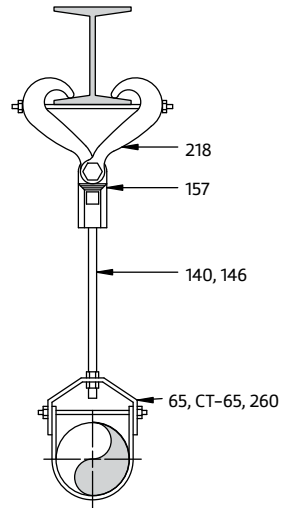
## Rigid Hanger Assemblies (Cont.)



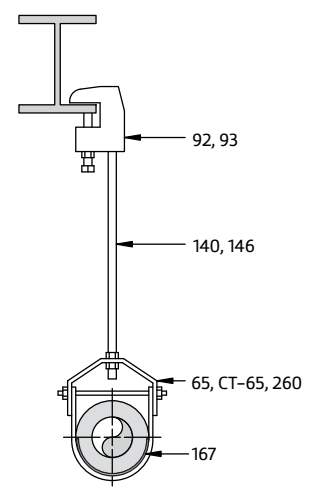
RH\_181\_157\_218.DWG, .DXF, or .EPS



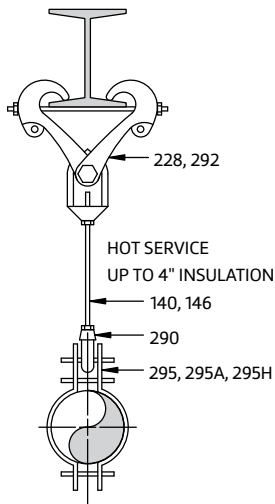
RH\_167\_65\_157\_218.DWG, .DXF, or .EPS



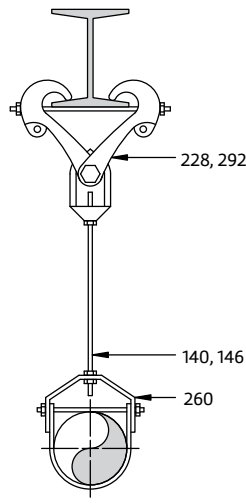
RH\_65\_157\_218.DWG, .DXF, or .EPS



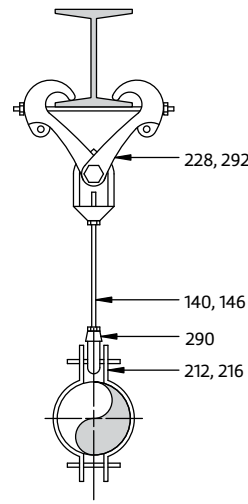
RH\_167\_65\_92.DWG, .DXF, or .EPS



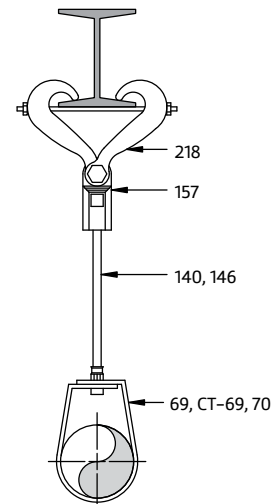
RH\_295\_290\_228.DWG, .DXF, or .EPS



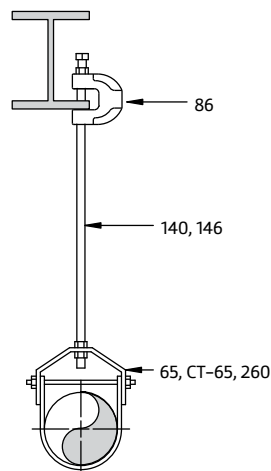
RH\_260\_228.DWG, .DXF, or .EPS



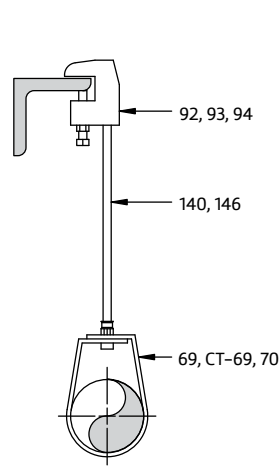
RH\_212\_290\_228.DWG, .DXF, or .EPS



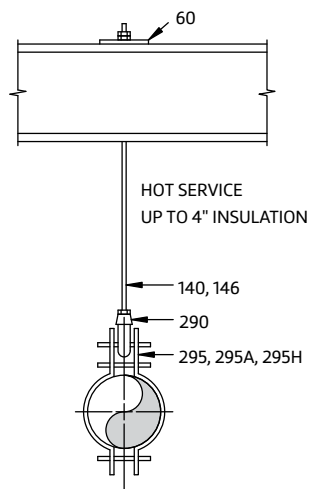
RH\_69\_157\_218.DWG, .DXF, or .EPS



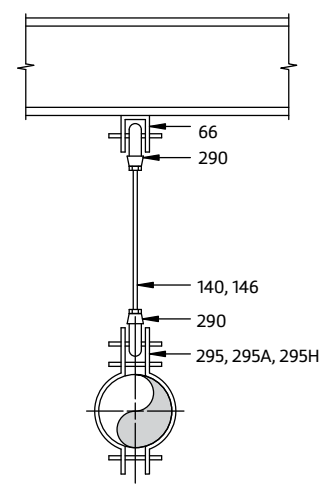
RH\_65\_86.DWG, .DXF, or .EPS



RH\_69\_92.DWG, .DXF, or .EPS



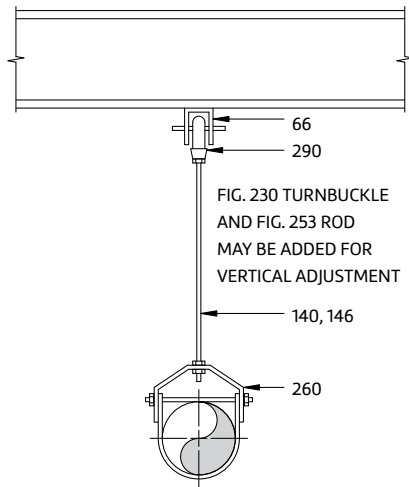
RH\_295\_290\_60.DWG, .DXF, or .EPS



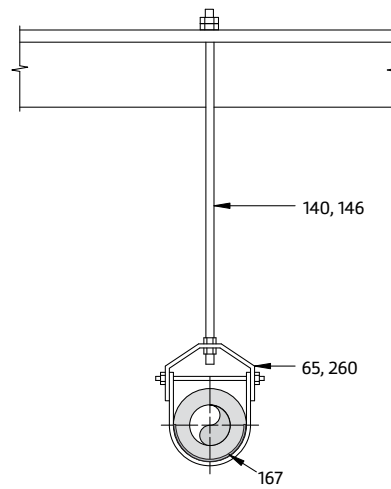
RH\_295\_290\_66.DWG, .DXF, or .EPS

Each of these drawings are available on the ASC website in CAD format. The file name at the bottom of each box refers to that CAD file.

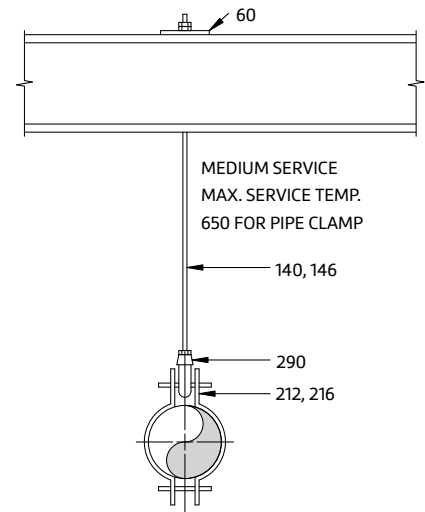
## Rigid Hanger Assemblies (Cont.)



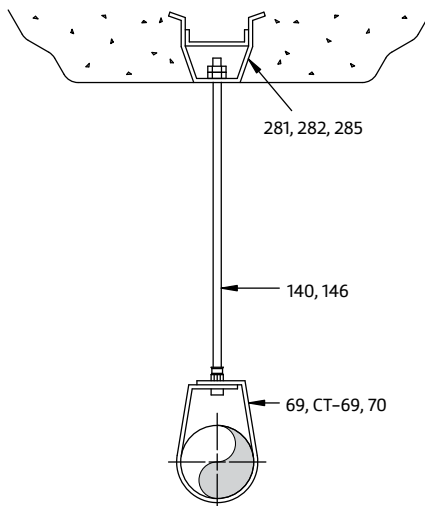
RH\_260\_290\_66.DWG, .DXF, or .EPS



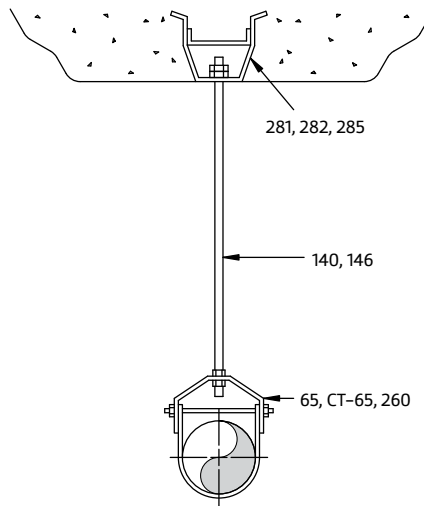
RH\_167\_65\_60.DWG, .DXF, or .EPS



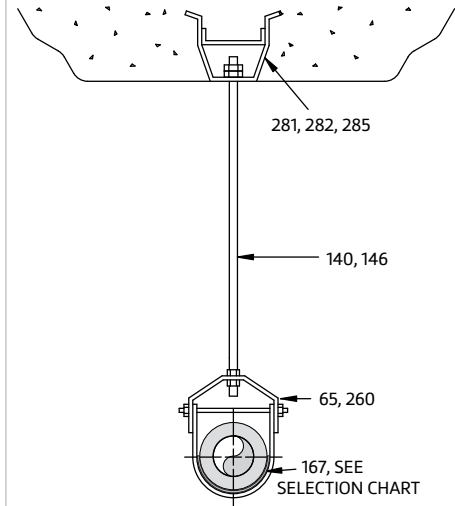
RH\_212\_290\_60.DWG, .DXF, or .EPS



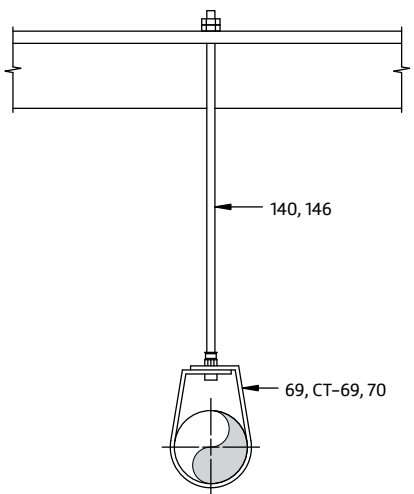
RH\_69\_281\_CI.DWG, .DXF, or .EPS



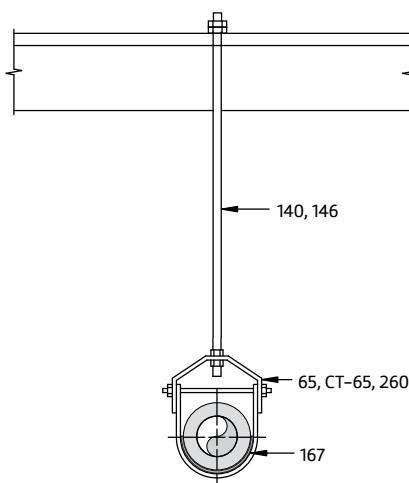
RH\_65\_281\_CI.DWG, .DXF, or .EPS



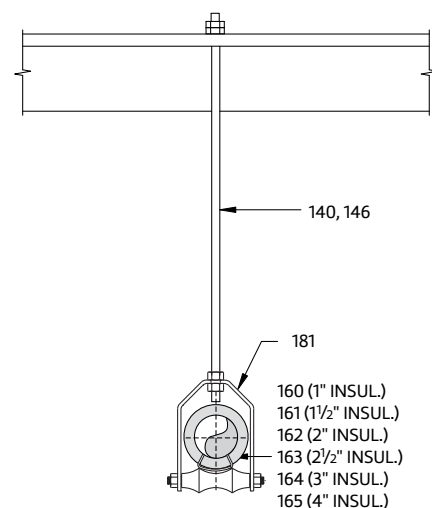
RH\_167\_65\_281\_CI.DWG, .DXF, or .EPS



RH\_69\_60.DWG, .DXF, or .EPS



RH\_160\_181\_60.DWG, .DXF, or .EPS



RH\_167\_260\_60.DWG, .DXF, or .EPS

Each of these drawings are available on the ASC website in CAD format. The file name at the bottom of each box refers to that CAD file.

## Weights of Piping Materials – Introduction

The tabulation of weights of standard piping materials presented on the following pages has been arranged for convenience of selection of data that formerly consumed considerable time to develop. For special materials, the three formulae listed below for weights of tubes, weights of contents of tubes, and weights of piping insulation will be helpful.

$$\text{Weight of Tube} = F \times 10.68 \times T \times (D - T) \text{ lb/ft}$$

T = Wall thickness in inches  
D = Outside diameter in inches  
F = Relative weight factor

The weight of tube furnished in this piping data is based on low carbon steel weighing 0.2833 lb/in<sup>3</sup>.

## Relative Weight Factor F

Aluminum	0.35
Brass	1.12
Cast Iron	0.91
Copper	1.14
Ferritic stainless steel	0.95
Austenitic stainless steel	1.02
Steel	1.00
Wrought iron	0.98

## Weight of Contents of Tube

$$\text{Weight of Tube Contents} = G \times .3405 \times (D - 2T)^2 \text{ lb/ft}$$

G = Specific gravity of contents  
T = Tube wall thickness in inches  
D = Tube outside diameter in inches

## Weight Tolerances

The weight per foot of steel pipe is subject to the following tolerances:

Specification	Tolerance
<b>ASTM A-120 &amp; ASTM A-53</b>	
STD WT	+5% -5%
XS WT	+5% -5%
XXS WT	+10% -10%
<b>ASTM A-106</b>	
SCH 10-120	+6.5% -3.5%
SCH 140-160	+10% -3.5%
<b>ASTM A-335</b>	
12" and under	+6.5% -3.5%
over 12"	+10% -5%
<b>ASTM A-312 &amp; ASTM A-376</b>	
12" and under	+6.5% -3.5%
API 5L All sizes	+6.5% -3.5%

The weight of welding tees and laterals are for full size fittings. The weights of reducing fittings are approximately the same as for full size fittings.

The weights of welding reducers are for one size reduction, and are approximately correct for other reductions. Weights of valves of the same type may vary because of individual manufacturer's designs. Listed valve weights are approximate only. Specific valve weights should be used when available. Where specific insulation thicknesses and densities differ from those shown, refer to "Weight of Piping Insulation" formula below.

## Weight of Piping Insulation

$$\text{Pipe Insulation Weight} = I \times .0218 \times T \times (D+T) \text{ lb/ft}$$

I = Insulation density in pounds per cubic foot  
T = Insulation thickness in inches  
D = Outside diameter of pipe in inches

Table III – Load Capacity of Threaded Hanger Rods in Accordance with MSS-SP58

Nominal Rod Diam. Inch	Root Area of Course Thread sq. in.	Max. Recommended Load at Rod Temp 650° Lbs
3/8	0.068	730
1/2	0.126	1,350
5/8	0.202	2,160
3/4	0.302	3,230
7/8	0.419	4,480
1	0.551	5,900
1 1/4	0.890	9,500
1 1/2	1.29	13,800
1 3/4	1.74	18,600
2	2.30	24,600
2 1/4	3.02	32,300
2 1/2	3.72	39,800
2 3/4	4.62	49,400
3	5.62	60,100
3 1/4	6.72	71,900
3 1/2	7.92	84,700
3 3/4	9.21	98,500
4	10.6	114,000
4 1/4	12.1	129,000
4 1/2	13.7	146,000
4 3/4	15.4	165,000
5	17.2	184,000



asc-es.com








Building connections that last™

# Weight of Piping Materials – 1" PIPE (1.313" O.D.)

## Pipe

Sch./Wall Designation -->	5S	10S	40/Std.	80/XS	160	XXS
Thickness -- In.	0.065	0.109	0.133	0.179	0.25	0.358
Pipe -- Lbs/Ft.	0.868	1.404	1.68	2.17	2.84	3.66
Water -- Lbs/Ft	0.478	0.409	0.37	0.31	0.23	0.12














## Welded Fittings – Line 1: Weight in Pounds, Line 2: Insulation Weight Factor

 L.R. 90° Elbow	<b>0.2</b> 0.3	<b>0.4</b> 0.3	<b>0.4</b> 0.3	<b>0.4</b> 0.3	<b>0.6</b> 0.3	<b>1.00</b> 0.3
 S.R. 90° Elbow			<b>0.3</b> 0.2			
 L.R. 45° Elbow	<b>0.1</b> 0.2	<b>0.3</b> 0.2	<b>0.3</b> 0.2	<b>0.3</b> 0.2	<b>0.4</b> 0.2	<b>0.5</b> 0.2
 Tee	<b>0.4</b> 0.4	<b>0.6</b> 0.4	<b>0.8</b> 0.4	<b>0.9</b> 0.4	<b>1.1</b> 0.4	<b>1.3</b> 0.4
 Lateral	<b>0.7</b> 1.1	<b>1.2</b> 1.1	<b>1.7</b> 1.1	<b>2.5</b> 1.1		
 Reducer	<b>0.2</b> 0.2	<b>0.4</b> 0.2	<b>0.3</b> 0.2	<b>0.4</b> 0.2	<b>0.5</b> 0.2	<b>0.5</b> 0.2
 Cap	<b>0.1</b> 0.3	<b>0.1</b> 0.3	<b>0.3</b> 0.3	<b>0.3</b> 0.3	<b>0.4</b> 0.3	<b>0.5</b> 0.3

**Note: Boldface black type** is weight in pounds and light grey type underneath is weight factor for insulation.

- Insulation thicknesses and weights are based on average conditions and do not constitute a recommendation for specific thicknesses of materials.
- Insulation weights are based on 85% magnesia and hydrous calcium silicate at 11 lbs/cu. foot. The listed thicknesses and weights of combination covering are the sums of the inner layer of diatomaceous earth at 21 lbs/cu. foot and the outer layer at 11 lbs/cubic foot.
- Insulation weights include allowances for wire, cement, canvas, bands and paint but not special surface finishes.
- To find the weight of covering on flanges, valves or fittings, multiply the weight factor by the weight per foot of covering used on straight pipe.
- Valve weights are approximate. Whenever possible, obtain weights from the manufacturer.
- Cast iron valve weights are for flanged end valves; steel weights for welding end valves.
- All flanged fitting, flanged valve and flange weights include the proportional weight of bolts or studs to make up all joints.

## Cast Iron & Steel Fittings – Line 1: Weight in Pounds, Line 2: Insulation Weight Factor

	Pressure Rating (PSI)									
	Cast Iron					Steel				
	125	250	150	300	400	600	900	1500	2500	
 Screwed or Slip On	<b>2.3</b> 1.5	<b>4</b> 1.5	<b>2.5</b> 1.5	<b>4</b> 1.5	<b>5</b> 1.5	<b>5</b> 1.5	<b>12</b> 1.5	<b>12</b> 1.5	<b>15</b> 1.5	
 Welding Neck			<b>3</b> 1.5	<b>5</b> 1.5	<b>7</b> 1.5	<b>7</b> 1.5	<b>12</b> 1.5	<b>12</b> 1.5	<b>16</b> 1.5	
 Lap Joint			<b>2.5</b> 1.5	<b>4</b> 1.5	<b>5</b> 1.5	<b>5</b> 1.5	<b>12</b> 1.5	<b>12</b> 1.5	<b>15</b> 1.5	
 Blind	<b>2.5</b> 1.5	<b>5</b> 1.5	<b>2.5</b> 1.5	<b>5</b> 1.5	<b>5</b> 1.5	<b>5</b> 1.5	<b>12</b> 1.5	<b>12</b> 1.5	<b>15</b> 1.5	
 S.R. 90° Elbow							<b>15</b> 3.7	<b>28</b> 3.8		
 L.R. 90° Elbow										
 45° Elbow							<b>14</b> 3.4	<b>26</b> 3.7		
 Tee							<b>20</b> 5.6	<b>39</b> 5.7		
 Flanged Bonnet Gate				<b>20</b> 1.2		<b>25</b> 1.5		<b>80</b> 4.3		
 Flanged Bonnet – Globe or Angle								<b>84</b> 3.5		
 Flanged Bonnet – Check										
 Pressure Seal – Bonnet, Gate							<b>31</b> 1.7	<b>31</b> 1.7		
 Pressure Seal – Bonnet, Globe										

## Pipe Insulation








Temp. Range -->	100 – 199	200 – 299	300 – 399	400 – 499	500 – 599	600 – 699	700 – 799	800 – 899	900 – 999	1,000 – 1,099	1,100 – 1,200
85% Magnesia Calcium Silicate	Nom. Thick., In. Lbs/Ft 1 0.72	1 0.72	1½ 1.23	2 1.94	2 1.94						
Combination						2½ 3.3	2½ 3.3	2½ 3.3	3 4.7	3 4.7	3 4.7

# Weight of Piping Materials – 1¼" PIPE (1.660" O.D.)

## Pipe

Sch./Wall Designation -->	5S	10S	40/Std.	80/XS	160	XXS
Thickness -- In.	0.065	0.109	0.00	0.191	0.00	0.382
Pipe -- Lbs/Ft.	1.11	1.81	2.27	3.00	3.77	5.22
Water -- Lbs/Ft	0.8	0.71	0.65	0.56	0.46	0.27














## Welded Fittings – Line 1: Weight in Pounds, Line 2: Insulation Weight Factor

 L.R. 90° Elbow	<b>0.3</b> 0.3	<b>0.5</b> 0.3	<b>0.6</b> 0.3	<b>0.8</b> 0.3	<b>1.0</b> 0.3	<b>1.3</b> 0.3
 S.R. 90° Elbow			<b>0.4</b> 0.2			
 L.R. 45° Elbow	<b>0.2</b> 0.2	<b>0.3</b> 0.2	<b>0.3</b> 0.2	<b>0.5</b> 0.2	<b>0.6</b> 0.2	<b>0.7</b> 0.2
 Tee	<b>0.7</b> 0.5	<b>1.1</b> 0.5	<b>1.6</b> 0.5	<b>1.6</b> 0.5	<b>1.9</b> 0.5	<b>2.4</b> 0.5
 Lateral	<b>1.1</b> 1.2	<b>1.9</b> 1.2	<b>2.4</b> 1.2	<b>3.8</b> 1.2		
 Reducer	<b>0.3</b> 0.2	<b>0.4</b> 0.2	<b>0.5</b> 0.2	<b>0.6</b> 0.2	<b>0.7</b> 0.2	<b>0.8</b> 0.2
 Cap	<b>0.1</b> 0.3	<b>0.1</b> 0.3	<b>0.4</b> 0.3	<b>0.4</b> 0.3	<b>0.6</b> 0.3	<b>0.6</b> 0.3

**Note: Boldface black type** is weight in pounds and light grey type underneath is weight factor for insulation.

- Insulation thicknesses and weights are based on average conditions and do not constitute a recommendation for specific thicknesses of materials.
- Insulation weights are based on 85% magnesia and hydrous calcium silicate at 11 lbs/cu. foot. The listed thicknesses and weights of combination covering are the sums of the inner layer of diatomaceous earth at 21 lbs/cu. foot and the outer layer at 11 lbs/cubic foot.
- Insulation weights include allowances for wire, cement, canvas, bands and paint but not special surface finishes.
- To find the weight of covering on flanges, valves or fittings, multiply the weight factor by the weight per foot of covering used on straight pipe.
- Valve weights are approximate. Whenever possible, obtain weights from the manufacturer.
- Cast iron valve weights are for flanged end valves; steel weights for welding end valves.
- All flanged fitting, flanged valve and flange weights include the proportional weight of bolts or studs to make up all joints.

## Cast Iron & Steel Fittings – Line 1: Weight in Pounds, Line 2: Insulation Weight Factor

	Pressure Rating (PSI)								
	Cast Iron			Steel					
	125	250	150	300	400	600	900	1500	2500
 Screwed or Slip On	<b>2.5</b> 1.5	<b>4.8</b> 1.5	<b>3.5</b> 1.5	<b>5</b> 1.5	<b>7</b> 1.5	<b>7</b> 1.5	<b>13</b> 1.5	<b>13</b> 1.5	<b>23</b> 1.5
 Welding Neck			<b>3</b> 1.5	<b>7</b> 1.5	<b>8</b> 1.5	<b>8</b> 1.5	<b>13</b> 1.5	<b>13</b> 1.5	<b>25</b> 1.5
 Lap Joint			<b>3.5</b> 1.5	<b>5</b> 1.5	<b>7</b> 1.5	<b>7</b> 1.5	<b>13</b> 1.5	<b>13</b> 1.5	<b>22</b> 1.5
 Blind	<b>2.8</b> 1.5	<b>5.5</b> 1.5	<b>3.5</b> 1.5	<b>4</b> 1.5	<b>7</b> 1.5	<b>7</b> 1.5	<b>13</b> 1.5	<b>13</b> 1.5	<b>23</b> 1.5
 S.R. 90° Elbow				<b>17</b> 3.7		<b>18</b> 3.8		<b>33</b> 3.9	
 L.R. 90° Elbow				<b>18</b> 3.9					
 45° Elbow				<b>15</b> 3.4		<b>16</b> 3.5		<b>31</b> 3.7	
 Tee				<b>23</b> 5.6		<b>20</b> 5.6		<b>49</b> 5.9	
 Flanged Bonnet Gate				<b>40</b> 4.0		<b>60</b> 4.2		<b>97</b> 4.6	
 Flanged Bonnet - Globe or Angle									
 Flanged Bonnet - Check				<b>21</b> 4.0					
 Pressure Seal - Bonnet, Gate							<b>38</b> 1.1	<b>38</b> 1.1	
 Pressure Seal - Bonnet, Globe									

## Pipe Insulation








Temp. Range -->	100 – 199	200 – 299	300 – 399	400 – 499	500 – 599	600 – 699	700 – 799	800 – 899	900 – 999	1,000 – 1,099	1,100 – 1,200
85% Magnesia Calcium Silicate	Nom. Thick., In. Lbs/Ft 1 0.65	1 0.65	1½ 1.47	2 1.83	2 1.83	2½ 2.65	2½ 2.65	2½ 2.65	3 3.58	3 3.58	3 3.58
Combination						2½ 3.17	2½ 3.17	2½ 3.17	3 5.76	3 5.76	3 5.76

# Weight of Piping Materials – 1½" PIPE (1.900" O.D.)

## Pipe

Sch./Wall Designation -->	5S	10S	40/Std.	80/XS	160	XXS		
Thickness -- In.	0.065	0.109	0.145	0.2	0.281	0.4	0.525	0.65
Pipe -- Lbs/Ft.	1.27	2.09	2.72	3.63	4.86	6.41	7.71	8.68
Water -- Lbs/Ft	1.07	0.96	0.88	0.77	0.61	0.41	0.25	0.12














## Welded Fittings – Line 1: Weight in Pounds, Line 2: Insulation Weight Factor

 L.R. 90° Elbow	<b>0.4</b> 0.4	<b>0.8</b> 0.4	<b>0.9</b> 0.4	<b>1.2</b> 0.4	<b>1.5</b> 0.4	<b>2.0</b> 0.4		
 S.R. 90° Elbow			<b>0.6</b> 0.3	<b>0.8</b> 0.3				
 L.R. 45° Elbow	<b>0.3</b> 0.2	<b>0.5</b> 0.2	<b>0.5</b> 0.2	<b>0.7</b> 0.2	<b>0.8</b> 0.2	<b>1.0</b> 0.2		
 Tee	<b>0.9</b> 0.6	<b>1.5</b> 0.6	<b>2.0</b> 0.6	<b>2.4</b> 0.6	<b>3</b> 0.6	<b>3.7</b> 0.6		
 Lateral	<b>1.3</b> 1.3	<b>2.1</b> 1.3	<b>3.3</b> 1.3	<b>5.5</b> 1.3				
 Reducer	<b>0.3</b> 0.2	<b>0.6</b> 0.2	<b>0.6</b> 0.2	<b>0.8</b> 0.2	<b>1.0</b> 0.2	<b>1.2</b> 0.2		
 Cap	<b>0.1</b> 0.3	<b>0.2</b> 0.3	<b>0.4</b> 0.3	<b>0.5</b> 0.3	<b>0.7</b> 0.3	<b>0.8</b> 0.3		

**Note: Boldface black type** is weight in pounds and **light grey type** underneath is weight factor for insulation.

- Insulation thicknesses and weights are based on average conditions and do not constitute a recommendation for specific thicknesses of materials.
- Insulation weights are based on 85% magnesia and hydrous calcium silicate at 11 lbs/cu. foot. The listed thicknesses and weights of combination covering are the sums of the inner layer of diatomaceous earth at 21 lbs/cu. foot and the outer layer at 11 lbs/cubic foot.
- Insulation weights include allowances for wire, cement, canvas, bands and paint but not special surface finishes.
- To find the weight of covering on flanges, valves or fittings, multiply the weight factor by the weight per foot of covering used on straight pipe.
- Valve weights are approximate. Whenever possible, obtain weights from the manufacturer.
- Cast iron valve weights are for flanged end valves; steel weights for welding end valves.
- All flanged fitting, flanged valve and flange weights include the proportional weight of bolts or studs to make up all joints.

## Cast Iron & Steel Fittings – Line 1: Weight in Pounds, Line 2: Insulation Weight Factor

	Pressure Rating (PSI)								
	Cast Iron			Steel					
	125	250	150	300	400	600	900	1500	2500
 Screwed or Slip On	<b>3</b> 1.5	<b>6</b> 1.5	<b>3.5</b> 1.5	<b>6</b> 1.5	<b>9</b> 1.5	<b>9</b> 1.5	<b>19</b> 1.5	<b>19</b> 1.5	<b>31</b> 1.5
 Welding Neck			<b>4.5</b> 1.5	<b>8</b> 1.5	<b>12</b> 1.5	<b>12</b> 1.5	<b>19</b> 1.5	<b>19</b> 1.5	<b>34</b> 1.5
 Lap Joint			<b>3.5</b> 1.5	<b>6</b> 1.5	<b>9</b> 1.5	<b>9</b> 1.5	<b>19</b> 1.5	<b>19</b> 1.5	<b>30</b> 1.5
 Blind	<b>4</b> 1.5	<b>6</b> 1.5	<b>3.5</b> 1.5	<b>8</b> 1.5	<b>10</b> 1.5	<b>10</b> 1.5	<b>19</b> 1.5	<b>19</b> 1.5	<b>31</b> 1.5
 S.R. 90° Elbow	<b>9</b> 3.7		<b>12</b> 3.7	<b>23</b> 3.8		<b>26</b> 3.9		<b>46</b> 4.0	
 L.R. 90° Elbow	<b>12</b> 4.0		<b>13</b> 4.0	<b>24</b> 4.0					
 45° Elbow	<b>8</b> 3.4		<b>11</b> 3.4	<b>21</b> 3.5		<b>23</b> 3.5		<b>39</b> 3.7	
 Tee	<b>15</b> 5.6		<b>20</b> 5.6	<b>30</b> 5.7		<b>37</b> 5.8		<b>70</b> 6.0	
 Flanged Bonnet Gate	<b>27</b> 6.8			<b>55</b> 4.2		<b>70</b> 4.5		<b>125</b> 5.0	
 Flanged Bonnet - Globe or Angle				<b>40</b> 4.2		<b>40</b> 4.2		<b>170</b> 5.0	
 Flanged Bonnet - Check			<b>30</b> 4.1	<b>35</b> 4.1		<b>40</b> 4.2		<b>110</b> 4.5	
 Pressure Seal - Bonnet, Gate							<b>42</b> 1.9	<b>42</b> 1.2	
 Pressure Seal - Bonnet, Globe									

## Pipe Insulation








Temp. Range -->	100 - 199	200 - 299	300 - 399	400 - 499	500 - 599	600 - 699	700 - 799	800 - 899	900 - 999	1,000 - 1,099	1,100 - 1,200
85% Magnesia Calcium Silicate	Nom. Thick., In. Lbs/Ft 1 0.84	1 0.84	1½ 1.35	2 2.52	2 2.52	2½ 3.47	2½ 3.47	2½ 3.47	3 4.52	3 4.52	3 4.52
Combination						2½ 4.2	2½ 4.2	2½ 4.2	3 5.62	3 5.62	3 5.62

# Weight of Piping Materials – 2" PIPE (2.375" O.D.)

## Pipe

Sch./Wall Designation -->	5S	10S	40/Std.	80/XS	160	XXS		
Thickness -- In.	0.065	0.109	0.154	0.218	0.343	0.436	0.562	0.687
Pipe -- Lbs/Ft.	1.60	2.64	3.65	5.02	7.44	9.03	10.88	12.39
Water -- Lbs/Ft	1.72	1.58	1.46	1.28	0.97	0.77	0.53	0.34














## Welded Fittings – Line 1: Weight in Pounds, Line 2: Insulation Weight Factor

 L.R. 90° Elbow	<b>0.6</b> 0.5	<b>1.1</b> 0.5	<b>1.5</b> 0.5	<b>2.1</b> 0.5	<b>3.0</b> 0.5	<b>4.0</b> 0.5		
 S.R. 90° Elbow			<b>1.0</b> 0.3	<b>1.4</b> 0.3				
 L.R. 45° Elbow	<b>0.4</b> 0.2	<b>0.6</b> 0.2	<b>0.9</b> 0.2	<b>1.1</b> 0.2	<b>1.6</b> 0.2	<b>2.0</b> 0.2		
 Tee	<b>1.1</b> 0.6	<b>1.8</b> 0.6	<b>2.9</b> 0.6	<b>3.7</b> 0.6	<b>4.9</b> 0.6	<b>5.7</b> 0.6		
 Lateral	<b>1.9</b> 1.4	<b>3.2</b> 1.4	<b>5.0</b> 1.4	<b>7.7</b> 1.4				
 Reducer	<b>0.4</b> 0.3	<b>0.9</b> 0.3	<b>0.9</b> 0.3	<b>1.2</b> 0.3	<b>1.6</b> 0.3	<b>1.9</b> 0.3		
 Cap	<b>0.2</b> 0.4	<b>0.3</b> 0.4	<b>0.6</b> 0.4	<b>0.7</b> 0.4	<b>1.1</b> 0.4	<b>1.2</b> 0.4		

**Note: Boldface black type** is weight in pounds and **light grey type** underneath is weight factor for insulation.

- Insulation thicknesses and weights are based on average conditions and do not constitute a recommendation for specific thicknesses of materials.
- Insulation weights are based on 85% magnesia and hydrous calcium silicate at 11 lbs/cu. foot. The listed thicknesses and weights of combination covering are the sums of the inner layer of diatomaceous earth at 21 lbs/cu. foot and the outer layer at 11 lbs/cubic foot.
- Insulation weights include allowances for wire, cement, canvas, bands and paint but not special surface finishes.
- To find the weight of covering on flanges, valves or fittings, multiply the weight factor by the weight per foot of covering used on straight pipe.
- Valve weights are approximate. Whenever possible, obtain weights from the manufacturer.
- Cast iron valve weights are for flanged end valves; steel weights for welding end valves.
- All flanged fitting, flanged valve and flange weights include the proportional weight of bolts or studs to make up all joints.

## Cast Iron & Steel Fittings – Line 1: Weight in Pounds, Line 2: Insulation Weight Factor

	Pressure Rating (PSI)									
	Cast Iron					Steel				
	125	250	150	300	400	600	900	1500	2500	
 Screwed or Slip On	<b>5</b> 1.5	<b>7</b> 1.5	<b>6</b> 1.5	<b>9</b> 1.5	<b>11</b> 1.5	<b>11</b> 1.5	<b>32</b> 1.5	<b>32</b> 1.5	<b>49</b> 1.5	
 Welding Neck			<b>7</b> 1.5	<b>11</b> 1.5	<b>14</b> 1.5	<b>14</b> 1.5	<b>32</b> 1.5	<b>32</b> 1.5	<b>53</b> 1.5	
 Lap Joint			<b>6</b> 1.5	<b>9</b> 1.5	<b>11</b> 1.5	<b>11</b> 1.5	<b>32</b> 1.5	<b>32</b> 1.5	<b>48</b> 1.5	
 Blind	<b>5</b> 1.5	<b>8</b> 1.5	<b>5</b> 1.5	<b>10</b> 1.5	<b>12</b> 1.5	<b>12</b> 1.5	<b>32</b> 1.5	<b>32</b> 1.5	<b>50</b> 1.5	
 S.R. 90° Elbow	<b>14</b> 3.8	<b>20</b> 3.8	<b>19</b> 3.8	<b>29</b> 3.8		<b>35</b> 4.0		<b>83</b> 4.2		
 L.R. 90° Elbow	<b>16</b> 4.1	<b>27</b> 4.1	<b>22</b> 4.1	<b>31</b> 4.1						
 45° Elbow	<b>12</b> 3.4	<b>18</b> 3.5	<b>16</b> 3.4	<b>24</b> 3.5		<b>33</b> 3.7		<b>73</b> 3.9		
 Tee	<b>21</b> 5.7	<b>32</b> 5.7	<b>27</b> 5.7	<b>41</b> 5.7		<b>52</b> 6.0		<b>129</b> 6.3		
 Flanged Bonnet Gate	<b>37</b> 6.9	<b>52</b> 7.1	<b>40</b> 4.0	<b>65</b> 4.2		<b>80</b> 4.5		<b>190</b> 5.0		
 Flanged Bonnet - Globe or Angle	<b>30</b> 7.0	<b>64</b> 7.3	<b>30</b> 3.8	<b>45</b> 4.0		<b>85</b> 4.5		<b>235</b> 5.5		
 Flanged Bonnet - Check	<b>26</b> 7.0	<b>51</b> 7.3	<b>35</b> 3.8	<b>40</b> 4.0		<b>60</b> 4.2		<b>300</b> 5.8		
 Pressure Seal - Bonnet, Gate								<b>150</b> 2.5		
 Pressure Seal - Bonnet, Globe								<b>165</b> 3.0		

## Pipe Insulation








Temp. Range -->	100 – 199	200 – 299	300 – 399	400 – 499	500 – 599	600 – 699	700 – 799	800 – 899	900 – 999	1,000 – 1,099	1,100 – 1,200
85% Magnesia Calcium Silicate	Nom. Thick., In. Lbs/Ft 1 1.01	1 1.01	1½ 1.71	2 2.53	2 2.53	2½ 3.48	2½ 3.48	3 4.42	3 4.42	3 4.42	3½ 5.59
Combination						2½ 4.28	2½ 4.28	3 5.93	3 5.93	3 5.93	3½ 7.80

# Weight of Piping Materials – 2½" PIPE (2.875" O.D.)

## Pipe

Sch./Wall Designation -->	5S	10S	40/Std.	80/XS	160	XXS		
Thickness -- In.	0.083	0.120	0.203	0.276	0.375	0.552	0.675	0.800
Pipe -- Lbs/Ft.	2.48	3.53	5.79	7.66	10.01	13.7	15.86	17.73
Water -- Lbs/Ft	2.50	2.36	2.08	1.84	1.54	1.07	0.79	0.55














## Welded Fittings – Line 1: Weight in Pounds, Line 2: Insulation Weight Factor

 L.R. 90° Elbow	<b>1.2</b> 0.6	<b>1.8</b> 0.6	<b>3.0</b> 0.6	<b>3.8</b> 0.6	<b>5.0</b> 0.6	<b>7.0</b> 0.6
 S.R. 90° Elbow			<b>2.2</b> 0.4	<b>2.5</b> 0.4		
 L.R. 45° Elbow	<b>0.7</b> 0.3	<b>0.6</b> 0.2	<b>0.9</b> 0.2	<b>1.1</b> 0.2	<b>1.6</b> 0.2	<b>2.0</b> 0.2
 Tee	<b>1.1</b> 0.6	<b>1.8</b> 0.6	<b>2.9</b> 0.6	<b>3.7</b> 0.6	<b>4.9</b> 0.6	<b>5.7</b> 0.6
 Lateral	<b>1.9</b> 1.4	<b>3.2</b> 1.4	<b>5.0</b> 1.4	<b>7.7</b> 1.4		
 Reducer	<b>0.4</b> 0.3	<b>0.9</b> 0.3	<b>0.9</b> 0.3	<b>1.2</b> 0.3	<b>1.6</b> 0.3	<b>1.9</b> 0.3
 Cap	<b>0.3</b> 0.4	<b>0.4</b> 0.4	<b>0.9</b> 4.0	<b>1.0</b> 0.4	<b>1.9</b> 0.4	<b>2.0</b> 0.4

**Note: Boldface black type** is weight in pounds and **light grey type** underneath is weight factor for insulation.

- Insulation thicknesses and weights are based on average conditions and do not constitute a recommendation for specific thicknesses of materials.
- Insulation weights are based on 85% magnesia and hydrous calcium silicate at 11 lbs/cu. foot. The listed thicknesses and weights of combination covering are the sums of the inner layer of diatomaceous earth at 21 lbs/cu. foot and the outer layer at 11 lbs/cubic foot.
- Insulation weights include allowances for wire, cement, canvas, bands and paint but not special surface finishes.
- To find the weight of covering on flanges, valves or fittings, multiply the weight factor by the weight per foot of covering used on straight pipe.
- Valve weights are approximate. Whenever possible, obtain weights from the manufacturer.
- Cast iron valve weights are for flanged end valves; steel weights for welding end valves.
- All flanged fitting, flanged valve and flange weights include the proportional weight of bolts or studs to make up all joints.

## Cast Iron & Steel Fittings – Line 1: Weight in Pounds, Line 2: Insulation Weight Factor

	Pressure Rating (PSI)									
	Cast Iron		Steel							
	125	250	150	300	400	600	900	1500	2500	
 Screwed or Slip On	<b>7</b> 1.5	<b>12.5</b> 1.5	<b>8</b> 1.5	<b>14</b> 1.5	<b>17</b> 1.5	<b>17</b> 1.5	<b>46</b> 1.5	<b>46</b> 1.5	<b>69</b> 1.5	
 Welding Neck			<b>11</b> 1.5	<b>16</b> 1.5	<b>22</b> 1.5	<b>22</b> 1.5	<b>46</b> 1.5	<b>46</b> 1.5	<b>66</b> 1.5	
 Lap Joint			<b>8</b> 1.5	<b>14</b> 1.5	<b>16</b> 1.5	<b>16</b> 1.5	<b>45</b> 1.5	<b>45</b> 1.5	<b>67</b> 1.5	
 Blind	<b>7.8</b> 1.5	<b>10</b> 1.5	<b>8</b> 1.5	<b>16</b> 1.5	<b>19</b> 1.5	<b>19</b> 1.5	<b>45</b> 1.5	<b>45</b> 1.5	<b>70</b> 1.5	
 S.R. 90° Elbow	<b>20</b> 3.8	<b>33</b> 3.9	<b>27</b> 3.8	<b>42</b> 3.9		<b>50</b> 4.1		<b>114</b> 4.4		
 L.R. 90° Elbow	<b>24</b> 4.2		<b>30</b> 4.2	<b>47</b> 4.2						
 45° Elbow	<b>18</b> 3.5	<b>31</b> 3.6	<b>22</b> 3.5	<b>35</b> 3.6		<b>46</b> 3.8		<b>99</b> 3.9		
 Tee	<b>31</b> 5.7	<b>49</b> 5.8	<b>42</b> 5.7	<b>61</b> 5.9		<b>77</b> 6.2		<b>169</b> 6.6		
 Flanged Bonnet Gate	<b>50</b> 7	<b>82</b> 7.1	<b>60</b> 4	<b>100</b> 4.2		<b>105</b> 4.6		<b>275</b> 5.2		
 Flanged Bonnet - Globe or Angle	<b>43</b> 7.1	<b>87</b> 7.4	<b>50</b> 4	<b>70</b> 4.1		<b>120</b> 4.6		<b>325</b> 5.5		
 Flanged Bonnet - Check	<b>36</b> 7.1	<b>71</b> 7.4	<b>40</b> 4.0	<b>50</b> 4.0		<b>105</b> 4.6		<b>320</b> 5.5		
 Pressure Seal - Bonnet, Gate									<b>215</b> 2.5	
 Pressure Seal - Bonnet, Globe										<b>230</b> 2.8

## Pipe Insulation








Temp. Range -->	100 – 199	200 – 299	300 – 399	400 – 499	500 – 599	600 – 699	700 – 799	800 – 899	900 – 999	1,000 – 1,099	1,100 – 1,200
85% Magnesia Calcium Silicate	Nom. Thick., In. Lbs/Ft 1 1.14	1 1.14	1½ 2.29	2 3.23	2 3.23	2½ 4.28	2½ 4.28	3 5.46	3 5.46	3½ 6.86	3½ 6.86
Combination						2½ 5.2	2½ 5.2	3 7.36	3 7.36	3½ 9.58	3½ 9.58

# Weight of Piping Materials – 3" PIPE (3.500" O.D.)

## Pipe

Sch./Wall Designation --->	5S	10S	40/Std.	80/XS	160	XXS		
Thickness -- In.	0.083	0.120	0.216	0.300	0.438	0.600	0.725	0.850
Pipe -- Lbs/Ft.	3.03	4.33	7.58	10.25	14.32	18.58	21.49	24.06
Water -- Lbs/Ft	3.78	3.61	3.20	2.86	2.35	1.80	1.43	1.10














## Welded Fittings – Line 1: Weight in Pounds, Line 2: Insulation Weight Factor

 L.R. 90° Elbow	<b>1.7</b> 0.8	<b>2.5</b> 0.8	<b>4.7</b> 0.8	<b>6.0</b> 0.8	<b>8.5</b> 0.8	<b>11.0</b> 0.8		
 S.R. 90° Elbow			<b>3.3</b> 0.5	<b>4.1</b> 0.5				
 L.R. 45° Elbow	<b>0.9</b> 0.3	<b>1.3</b> 0.3	<b>2.5</b> 0.3	<b>3.3</b> 0.3	<b>4.5</b> 0.3	<b>5.5</b> 0.3		
 Tee	<b>2.7</b> 0.8	<b>3.9</b> 0.8	<b>7.0</b> 0.8	<b>10</b> 0.8	<b>12.2</b> 0.8	<b>14.8</b> 0.8		
 Lateral	<b>4.5</b> 1.8	<b>6.4</b> 1.8	<b>12.5</b> 1.8	<b>18</b> 1.8				
 Reducer	<b>0.8</b> 0.3	<b>1.5</b> 0.3	<b>2.1</b> 0.3	<b>2.8</b> 0.3	<b>3.7</b> 0.3	<b>4.6</b> 0.3		
 Cap	<b>0.5</b> 0.5	<b>0.7</b> 0.5	<b>1.4</b> 0.5	<b>1.8</b> 0.5	<b>3.5</b> 0.5	<b>3.6</b> 0.5		

**Note: Boldface black type** is weight in pounds and **light grey type** underneath is weight factor for insulation.

- Insulation thicknesses and weights are based on average conditions and do not constitute a recommendation for specific thicknesses of materials.
- Insulation weights are based on 85% magnesia and hydrous calcium silicate at 11 lbs/cu. foot. The listed thicknesses and weights of combination covering are the sums of the inner layer of diatomaceous earth at 21 lbs/cu. foot and the outer layer at 11 lbs/cubic foot.
- Insulation weights include allowances for wire, cement, canvas, bands and paint but not special surface finishes.
- To find the weight of covering on flanges, valves or fittings, multiply the weight factor by the weight per foot of covering used on straight pipe.
- Valve weights are approximate. Whenever possible, obtain weights from the manufacturer.
- Cast iron valve weights are for flanged end valves; steel weights for welding end valves.
- All flanged fitting, flanged valve and flange weights include the proportional weight of bolts or studs to make up all joints.

## Cast Iron & Steel Fittings – Line 1: Weight in Pounds, Line 2: Insulation Weight Factor

	Pressure Rating (PSI)									
	Cast Iron					Steel				
	125	250	150	300	400	600	900	1500	2500	
 Screwed or Slip On	<b>8.6</b> 1.5	<b>15.8</b> 1.5	<b>9</b> 1.5	<b>17</b> 1.5	<b>20</b> 1.5	<b>20</b> 1.5	<b>37</b> 1.5	<b>61</b> 1.5	<b>102</b> 1.5	
 Welding Neck			<b>12</b> 1.5	<b>19</b> 1.5	<b>27</b> 1.5	<b>27</b> 1.5	<b>38</b> 1.5	<b>61</b> 1.5	<b>113</b> 1.5	
 Lap Joint			<b>9</b> 1.5	<b>17</b> 1.5	<b>19</b> 1.5	<b>19</b> 1.5	<b>36</b> 1.5	<b>60</b> 1.5	<b>99</b> 1.5	
 Blind	<b>9</b> 1.5	<b>17.5</b> 1.5	<b>10</b> 1.5	<b>20</b> 1.5	<b>24</b> 1.5	<b>24</b> 1.5	<b>38</b> 1.5	<b>61</b> 1.5	<b>105</b> 1.5	
 S.R. 90° Elbow	<b>25</b> 3.9	<b>44</b> 4.0	<b>32</b> 3.9	<b>53</b> 4.0		<b>67</b> 4.1	<b>98</b> 4.3	<b>150</b> 4.6		
 L.R. 90° Elbow	<b>29</b> 4.3		<b>40</b> 4.3	<b>63</b> 4.3						
 45° Elbow	<b>21</b> 3.5	<b>39</b> 3.6	<b>28</b> 3.5	<b>46</b> 3.6		<b>60</b> 3.8	<b>93</b> 3.9	<b>135</b> 4.0		
 Tee	<b>38</b> 5.9	<b>62</b> 6.0	<b>52</b> 5.9	<b>81</b> 6.0		<b>102</b> 6.2	<b>151</b> 6.5	<b>238</b> 6.9		
 Flanged Bonnet Gate	<b>66</b> 7.0	<b>112</b> 7.4	<b>70</b> 4.0	<b>125</b> 4.4		<b>155</b> 4.8	<b>260</b> 5.0	<b>410</b> 5.5		
 Flanged Bonnet - Globe or Angle	<b>56</b> 7.2	<b>87</b> 7.6	<b>60</b> 4.3	<b>95</b> 4.5		<b>155</b> 4.8	<b>225</b> 5.0	<b>495</b> 5.5		
 Flanged Bonnet - Check	<b>46</b> 7.2	<b>100</b> 7.6	<b>60</b> 4.3	<b>70</b> 4.4		<b>120</b> 4.8	<b>150</b> 4.9	<b>440</b> 5.8		
 Pressure Seal - Bonnet, Gate							<b>208</b> 3.0	<b>235</b> 3.2		
 Pressure Seal - Bonnet, Globe								<b>135</b> 2.5	<b>180</b> 3.0	

## Pipe Insulation








Temp. Range --->	100 – 199	200 – 299	300 – 399	400 – 499	500 – 599	600 – 699	700 – 799	800 – 899	900 – 999	1,000 – 1,099	1,100 – 1,200
85% Magnesia Calcium Silicate	Nom. Thick., In. Lbs/Ft 1 1.25	1 1.25	1½ 2.08	2 3.01	2 3.01	2½ 4.07	3 5.24	3 5.24	3 5.24	3½ 6.65	3½ 6.65
Combination	Nom. Thick., In. Lbs/Ft					2½ 5.07	3 6.94	3 6.94	3 6.94	3½ 9.17	3½ 9.17

# Weight of Piping Materials – 3½" PIPE (4.000" O.D.)

## Pipe

Sch./Wall Designation -->	5S	10S	40/Std.	80/XS	160
Thickness -- In.	0.083	0.12	0.226	0.318	0.636
Pipe -- Lbs/Ft.	3.47	4.97	9.11	12.51	22.85
Water -- Lbs/Ft	5.01	4.81	4.28	3.85	2.53














## Welded Fittings – Line 1: Weight in Pounds, Line 2: Insulation Weight Factor

 L.R. 90° Elbow	<b>2.4</b> 0.9	<b>3.4</b> 0.9	<b>6.7</b> 0.9	<b>8.7</b> 0.9	<b>15.0</b> 9.0
 S.R. 90° Elbow			<b>4.2</b> 0.6	<b>5.7</b> 0.6	
 L.R. 45° Elbow	<b>1.2</b> 4.0	<b>1.7</b> 0.4	<b>3.3</b> 0.4	<b>4.4</b> 0.4	<b>8.0</b> 0.4
 Tee	<b>3.4</b> 0.9	<b>4.9</b> 0.0	<b>10.3</b> 0.9	<b>13.8</b> 0.9	<b>20.2</b> 0.9
 Lateral	<b>6.2</b> 1.8	<b>8.9</b> 1.8	<b>17.2</b> 1.8	<b>25</b> 1.8	
 Reducer	<b>1.2</b> 0.3	<b>2.1</b> 0.3	<b>3.0</b> 0.3	<b>4.0</b> 0.3	<b>6.8</b> 0.3
 Cap	<b>0.6</b> 0.6	<b>0.8</b> 0.6	<b>2.1</b> 0.6	<b>2.8</b> 0.6	<b>5.5</b> 0.6

**Note: Boldface black type** is weight in pounds and light grey type underneath is weight factor for insulation.

- Insulation thicknesses and weights are based on average conditions and do not constitute a recommendation for specific thicknesses of materials.
- Insulation weights are based on 85% magnesia and hydrous calcium silicate at 11 lbs/cu. foot. The listed thicknesses and weights of combination covering are the sums of the inner layer of diatomaceous earth at 21 lbs/cu. foot and the outer layer at 11 lbs/cubic foot.
- Insulation weights include allowances for wire, cement, canvas, bands and paint but not special surface finishes.
- To find the weight of covering on flanges, valves or fittings, multiply the weight factor by the weight per foot of covering used on straight pipe.
- Valve weights are approximate. Whenever possible, obtain weights from the manufacturer.
- Cast iron valve weights are for flanged end valves; steel weights for welding end valves.
- All flanged fitting, flanged valve and flange weights include the proportional weight of bolts or studs to make up all joints.

## Cast Iron & Steel Fittings – Line 1: Weight in Pounds, Line 2: Insulation Weight Factor

	Pressure Rating (PSI)									
	Cast Iron					Steel				
	125	250	150	300	400	600	900	1500	2500	
 Screwed or Slip On	<b>11</b> 1.5	<b>20</b> 1.5	<b>13</b> 1.5	<b>21</b> 1.5	<b>27</b> 1.5	<b>27</b> 1.5				
 Welding Neck				<b>14</b> 1.5	<b>22</b> 1.5	<b>32</b> 1.5	<b>32</b> 1.5			
 Lap Joint				<b>13</b> 1.5	<b>21</b> 1.5	<b>26</b> 1.5	<b>26</b> 1.5			
 Blind	<b>13</b> 1.5	<b>23</b> 1.5	<b>15</b> 1.5	<b>25</b> 1.5	<b>35</b> 1.5	<b>35</b> 1.5				
 S.R. 90° Elbow	<b>33</b> 4.0			<b>49</b> 4.0			<b>82</b> 4.3			
 L.R. 90° Elbow				<b>54</b> 4.4						
 45° Elbow	<b>29</b> 3.6			<b>39</b> 3.6			<b>75</b> 3.6			
 Tee	<b>51</b> 6.0	<b>103</b> 6.2	<b>70</b> 6.0				<b>133</b> 6.4			
 Flanged Bonnet Gate	<b>82</b> 7.1	<b>143</b> 7.5	<b>90</b> 4.1	<b>155</b> 4.5			<b>180</b> 4.8	<b>360</b> 5.0	<b>510</b> 5.5	
 Flanged Bonnet - Globe or Angle	<b>74</b> 7.3	<b>137</b> 7.7					<b>160</b> 4.7			
 Flanged Bonnet - Check	<b>71</b> 7.3	<b>125</b> 7.7					<b>125</b> 4.7			
 Pressure Seal - Bonnet, Gate							<b>140</b> 2.5	<b>295</b> 2.8	<b>380</b> 3.0	
 Pressure Seal - Bonnet, Globe										

## Pipe Insulation








Temp. Range -->	100 – 199	200 – 299	300 – 399	400 – 499	500 – 599	600 – 699	700 – 799	800 – 899	900 – 999	1,000 – 1,099	1,100 – 1,200
85% Magnesia Calcium Silicate	Nom. Thick., In. Lbs/Ft 1 1.83	1 1.83	1½ 2.77	2 3.71	2½ 4.88	2½ 4.88	3 6.39	3 6.39	3½ 7.8	3½ 7.8	3½ 7.8
Combination					2½ 6.49	3 8.71	3 8.71	3½ 10.8	3½ 10.8	3½ 10.8	3½ 10.8

# Weight of Piping Materials – 4" PIPE (4.500" O.D.)

## Pipe

Sch./Wall Designation -->	5S	10S	40/Std.	80/XS	120	160	XXS				
Thickness -- In.	0.083	0.12	0.188	0.237	0.337	0.438	0.500	0.531	0.674	0.800	0.925
Pipe -- Lbs/Ft.	3.92	5.61	8.56	10.79	14.98	18.96	21.36	22.51	27.54	31.61	35.32
Water -- Lbs/Ft	6.40	6.17	5.80	5.51	4.98	4.48	4.16	4.02	3.38	2.86	2.39














## Welded Fittings – Line 1: Weight in Pounds, Line 2: Insulation Weight Factor

 L.R. 90° Elbow	<b>3.0</b> 1.0	<b>4.3</b> 1.0	<b>8.7</b> 1.0	<b>12</b> 1.0		<b>18</b> 1.0	<b>20.5</b> 1.0
 S.R. 90° Elbow			<b>6.7</b> 0.7	<b>8.3</b> 0.7			
 L.R. 45° Elbow	<b>1.5</b> 0.4	<b>2.2</b> 0.4	<b>4.3</b> 0.4	<b>5.9</b> 0.4		<b>8.5</b> 0.4	<b>10.0</b> 4.0
 Tee	<b>3.9</b> 1.0	<b>5.7</b> 1.0	<b>13.5</b> 1.0	<b>16.4</b> 1.0		<b>22.8</b> 1.0	<b>26.6</b> 1.0
 Lateral	<b>6.6</b> 2.1	<b>10.0</b> 2.1	<b>20.5</b> 2.1	<b>32.0</b> 2.1			
 Reducer	<b>1.2</b> 0.3	<b>2.4</b> 0.3	<b>3.6</b> 0.3	<b>4.8</b> 0.3		<b>6.6</b> 0.3	<b>8.2</b> 0.3
 Cap	<b>0.8</b> 0.3	<b>1.2</b> 0.3	<b>2.5</b> 0.5	<b>3.4</b> 0.5		<b>6.5</b> 6.5	<b>6.6</b> 6.6

**Note: Boldface black type** is weight in pounds and **light grey type** underneath is weight factor for insulation.

- Insulation thicknesses and weights are based on average conditions and do not constitute a recommendation for specific thicknesses of materials.
- Insulation weights are based on 85% magnesia and hydrous calcium silicate at 11 lbs/cu. foot. The listed thicknesses and weights of combination covering are the sums of the inner layer of diatomaceous earth at 21 lbs/cu. foot and the outer layer at 11 lbs/cubic foot.
- Insulation weights include allowances for wire, cement, canvas, bands and paint but not special surface finishes.
- To find the weight of covering on flanges, valves or fittings, multiply the weight factor by the weight per foot of covering used on straight pipe.
- Valve weights are approximate. Whenever possible, obtain weights from the manufacturer.
- Cast iron valve weights are for flanged end valves; steel weights for welding end valves.
- All flanged fitting, flanged valve and flange weights include the proportional weight of bolts or studs to make up all joints.

## Cast Iron & Steel Fittings – Line 1: Weight in Pounds, Line 2: Insulation Weight Factor

	Pressure Rating (PSI)									
	Cast Iron					Steel				
	125	250	150	300	400	600	900	1500	2500	
 Screwed or Slip On	<b>14</b> 1.5	<b>24</b> 1.5	<b>15</b> 1.5	<b>26</b> 1.5	<b>32</b> 1.5	<b>43</b> 1.5	<b>66</b> 1.5	<b>90</b> 1.5	<b>158</b> 1.5	
 Welding Neck			<b>17</b> 1.5	<b>29</b> 1.5	<b>41</b> 1.5	<b>48</b> 1.5	<b>64</b> 1.5	<b>90</b> 1.5	<b>177</b> 1.5	
 Lap Joint			<b>15</b> 1.5	<b>26</b> 1.5	<b>31</b> 1.5	<b>42</b> 1.5	<b>64</b> 1.5	<b>92</b> 1.5	<b>153</b> 1.5	
 Blind	<b>16</b> 1.5	<b>27</b> 1.5	<b>19</b> 1.5	<b>31</b> 1.5	<b>39</b> 1.5	<b>47</b> 1.5	<b>67</b> 1.5	<b>90</b> 1.5	<b>164</b> 1.5	
 S.R. 90° Elbow	<b>43</b> 4.1	<b>69</b> 4.2	<b>59</b> 4.1	<b>85</b> 4.2	<b>99</b> 4.3	<b>128</b> 4.4	<b>185</b> 4.5	<b>254</b> 4.8		
 L.R. 90° Elbow			<b>50</b> 4.5	<b>72</b> 4.5	<b>98</b> 4.5					
 45° Elbow	<b>38</b> 3.7	<b>62</b> 3.8	<b>51</b> 3.7	<b>78</b> 3.8	<b>82</b> 3.9	<b>119</b> 4	<b>170</b> 4.1	<b>214</b> 4.2		
 Tee	<b>66</b> 6.1	<b>103</b> 6.3	<b>86</b> 6.1	<b>121</b> 6.3	<b>153</b> 6.4	<b>187</b> 6.6	<b>262</b> 6.8	<b>386</b> 7.2		
 Flanged Bonnet Gate	<b>109</b> 7.2	<b>188</b> 7.5	<b>100</b> 4.2	<b>175</b> 4.5	<b>195</b> 5.0	<b>255</b> 5.1	<b>455</b> 5.4	<b>735</b> 6.0		
 Flanged Bonnet - Globe or Angle	<b>97</b> 7.4	<b>177</b> 7.8	<b>95</b> 4.3	<b>145</b> 4.8	<b>215</b> 5	<b>230</b> 5.1	<b>415</b> 5.5	<b>800</b> 6.0		
 Flanged Bonnet - Check	<b>80</b> 7.4	<b>146</b> 7.8	<b>80</b> 4.3	<b>105</b> 4.5	<b>160</b> 4.8	<b>195</b> 5.0	<b>320</b> 5.6	<b>780</b> 6.0		
 Pressure Seal - Bonnet, Gate						<b>215</b> 2.8	<b>380</b> 3.0	<b>520</b> 4.0		
 Pressure Seal - Bonnet, Globe							<b>240</b> 2.7	<b>290</b> 3.0		

## Pipe Insulation








Temp. Range -->	100 – 199	200 – 299	300 – 399	400 – 499	500 – 599	600 – 699	700 – 799	800 – 899	900 – 999	1,000 – 1,099	1,100 – 1,200
85% Magnesia Calcium Silicate	Nom. Thick., In. Lbs/Ft 1 1.62	1 1.62	1½ 2.55	2 3.61	2½ 4.66	2½ 4.66	3 6.07	3 6.07	3½ 7.48	3½ 7.48	4 9.1
Combination						2½ 6.07	3 8.3	3 8.3	3½ 10.6	3½ 10.6	3½ 10.6

# Weight of Piping Materials – 5" PIPE (5.563" O.D.)

## Pipe

Sch./Wall Designation -->	5S	10S	40/Std.	80/XS	120	160	XXS		
Thickness -- In.	0.109	0.134	0.258	0.375	0.500	0.625	0.750	0.875	1.000
Pipe -- Lbs/Ft.	6.35	7.77	14.62	20.78	27.04	32.96	38.55	43.81	47.73
Water -- Lbs/Ft	9.73	9.53	8.66	7.89	7.09	6.33	5.62	4.95	4.23














## Welded Fittings – Line 1: Weight in Pounds, Line 2: Insulation Weight Factor

 L.R. 90° Elbow	<b>6.0</b> 1.3	<b>7.4</b> 1.3	<b>16.0</b> 1.3	<b>21.4</b> 1.3		<b>33.0</b> 1.3	<b>34.0</b> 1.3		
 S.R. 90° Elbow	<b>4.2</b> 0.8	<b>5.2</b> 0.8	<b>10.4</b> 0.8	<b>14.5</b> 0.8					
 L.R. 45° Elbow	<b>3.1</b> 0.5	<b>3.8</b> 0.5	<b>8.3</b> 0.5	<b>10.5</b> 0.5		<b>14.0</b> 0.5	<b>18.0</b> 0.5		
 Tee	<b>9.8</b> 1.2	<b>12</b> 1.2	<b>19.8</b> 1.2	<b>26.9</b> 1.2		<b>38.5</b> 1.2	<b>43.4</b> 1.2		
 Lateral	<b>15.3</b> 2.5	<b>18.4</b> 2.5	<b>31.0</b> 2.5	<b>49</b> 2.5					
 Reducer	<b>2.5</b> 0.4	<b>4.3</b> 0.4	<b>5.9</b> 0.4	<b>8.3</b> 0.4		<b>12.4</b> 0.4	<b>14.2</b> 0.4		
 Cap	<b>1.3</b> 0.7	<b>1.6</b> 0.7	<b>4.2</b> 0.7	<b>5.7</b> 0.7		<b>11.0</b> 0.7	<b>11.0</b> 0.7		

**Note: Boldface black type** is weight in pounds and light grey type underneath is weight factor for insulation.

- Insulation thicknesses and weights are based on average conditions and do not constitute a recommendation for specific thicknesses of materials.
- Insulation weights are based on 85% magnesia and hydrous calcium silicate at 11 lbs/cu. foot. The listed thicknesses and weights of combination covering are the sums of the inner layer of diatomaceous earth at 21 lbs/cu. foot and the outer layer at 11 lbs/cubic foot.
- Insulation weights include allowances for wire, cement, canvas, bands and paint but not special surface finishes.
- To find the weight of covering on flanges, valves or fittings, multiply the weight factor by the weight per foot of covering used on straight pipe.
- Valve weights are approximate. Whenever possible, obtain weights from the manufacturer.
- Cast iron valve weights are for flanged end valves; steel weights for welding end valves.
- All flanged fitting, flanged valve and flange weights include the proportional weight of bolts or studs to make up all joints.

## Cast Iron & Steel Fittings – Line 1: Weight in Pounds, Line 2: Insulation Weight Factor

	Pressure Rating (PSI)									
	Cast Iron		Steel							
	125	250	150	300	400	600	900	1500	2500	
 Screwed or Slip On	<b>17</b> 1.5	<b>28</b> 1.5	<b>18</b> 1.5	<b>32</b> 1.5	<b>37</b> 1.5	<b>73</b> 1.5	<b>100</b> 1.5	<b>162</b> 1.5	<b>259</b> 1.5	
 Welding Neck			<b>22</b> 1.5	<b>36</b> 1.5	<b>49</b> 1.5	<b>78</b> 1.5	<b>103</b> 1.5	<b>162</b> 1.5	<b>293</b> 1.5	
 Lap Joint			<b>18</b> 1.5	<b>32</b> 1.5	<b>35</b> 1.5	<b>71</b> 1.5	<b>98</b> 1.5	<b>168</b> 1.5	<b>253</b> 1.5	
 Blind	<b>21</b> 1.5	<b>35</b> 1.5	<b>23</b> 1.5	<b>39</b> 1.5	<b>50</b> 1.5	<b>78</b> 1.5	<b>104</b> 1.5	<b>172</b> 1.5	<b>272</b> 1.5	
 S.R. 90° Elbow	<b>55</b> 4.3	<b>91</b> 4.3	<b>80</b> 4.3	<b>113</b> 4.3	<b>123</b> 4.5	<b>205</b> 4.7	<b>268</b> 4.8	<b>435</b> 5.2		
 L.R. 90° Elbow	<b>65</b> 4.7		<b>91</b> 4.7	<b>128</b> 4.7						
 45° Elbow	<b>48</b> 3.8	<b>80</b> 3.8	<b>66</b> 3.8	<b>98</b> 3.8	<b>123</b> 4.0	<b>180</b> 4.2	<b>239</b> 4.3	<b>350</b> 4.5		
 Tee	<b>84</b> 6.4	<b>139</b> 6.5	<b>119</b> 6.4	<b>172</b> 6.4	<b>179</b> 6.8	<b>304</b> 7.0	<b>415</b> 7.2	<b>665</b> 7.8		
 Flanged Bonnet Gate	<b>138</b> 7.3	<b>264</b> 7.9	<b>150</b> 4.3	<b>265</b> 4.9	<b>310</b> 5.3	<b>455</b> 5.5	<b>615</b> 6.0	<b>1340</b> 7.0		
 Flanged Bonnet - Globe or Angle	<b>138</b> 7.6	<b>247</b> 8	<b>155</b> 4.3	<b>215</b> 5.0	<b>355</b> 5.2	<b>515</b> 5.8	<b>555</b> 5.8	<b>950</b> 6.0		
 Flanged Bonnet - Check	<b>118</b> 7.6	<b>210</b> 8.0	<b>110</b> 4.3	<b>165</b> 5.0	<b>185</b> 5.0	<b>350</b> 5.8	<b>560</b> 6.0	<b>1150</b> 7.0		
 Pressure Seal - Bonnet, Gate						<b>350</b> 3.1	<b>520</b> 3.8	<b>865</b> 4.5		
 Pressure Seal - Bonnet, Globe							<b>280</b> 4.0	<b>450</b> 4.5		

## Pipe Insulation







Temp. Range -->	100 – 199	200 – 299	300 – 399	400 – 499	500 – 599	600 – 699	700 – 799	800 – 899	900 – 999	1,000 – 1,099	1,100 – 1,200
85% Magnesia Calcium Silicate	Nom. Thick., In. Lbs/Ft 1 1.86	1½ 2.92	1½ 2.92	2 4.08	2½ 5.38	2½ 5.38	3 6.9	3½ 8.41	3½ 8.41	4 10.4	4 10.4
Combination						2½ 7.01	3 9.3	3½ 11.8	3½ 11.8	4 14.9	4 14.9

# Weight of Piping Materials – 6" PIPE (6.625" O.D.)

## Pipe

Sch./Wall Designation -->	5S	10S	40/Std.	80/XS	120	160	XXS			
Thickness -- In.	0.109	0.134	0.219	0.28	0.432	0.562	0.718	0.864	1.00	1.125
Pipe -- Lbs/Ft.	5.37	9.29	15.02	18.97	28.57	36.39	45.3	53.2	60.01	66.08
Water -- Lbs/Ft	13.98	13.74	13.1	12.51	11.29	10.3	9.2	8.2	7.28	6.52














## Welded Fittings – Line 1: Weight in Pounds, Line 2: Insulation Weight Factor

 L.R. 90° Elbow	<b>8.9</b> 1.5	<b>11.0</b> 1.5	<b>22.8</b> 1.5	<b>32.2</b> 1.5	<b>43.0</b> 1.5	<b>55.0</b> 1.6	<b>62.0</b> 1.5			
 S.R. 90° Elbow	<b>6.1</b> 1.0	<b>7.5</b> 1.0	<b>16.6</b> 1.0	<b>22.9</b> 1.0	<b>30.0</b> 1.0					
 L.R. 45° Elbow	<b>4.5</b> 0.6	<b>5.5</b> 0.6	<b>11.3</b> 0.6	<b>16.4</b> 0.6	<b>21</b> 0.6	<b>26.0</b> 0.6	<b>30</b> 0.6			
 Tee	<b>13.8</b> 1.4	<b>17.0</b> 1.4	<b>31.3</b> 1.4	<b>39.5</b> 1.4		<b>59.0</b> 1.4	<b>68.0</b> 1.4			
 Lateral	<b>16.7</b> 2.9	<b>20.5</b> 2.9	<b>42.0</b> 2.9	<b>78.0</b> 2.9						
 Reducer	<b>3.3</b> 0.5	<b>5.8</b> 0.5	<b>8.6</b> 0.6	<b>12.6</b> 0.5		<b>18.8</b> 0.5	<b>21.4</b> 0.5			
 Cap	<b>1.6</b> 0.9	<b>1.9</b> 0.9	<b>6.4</b> 0.9	<b>9.2</b> 0.9	<b>13.3</b> 0.9	<b>17.5</b> 0.9	<b>17.5</b> 0.9			

**Note: Boldface black type** is weight in pounds and **light grey type** underneath is weight factor for insulation.

- Insulation thicknesses and weights are based on average conditions and do not constitute a recommendation for specific thicknesses of materials.
- Insulation weights are based on 85% magnesia and hydrous calcium silicate at 11 lbs/cu. foot. The listed thicknesses and weights of combination covering are the sums of the inner layer of diatomaceous earth at 21 lbs/cu. foot and the outer layer at 11 lbs/cubic foot.
- Insulation weights include allowances for wire, cement, canvas, bands and paint but not special surface finishes.
- To find the weight of covering on flanges, valves or fittings, multiply the weight factor by the weight per foot of covering used on straight pipe.
- Valve weights are approximate. Whenever possible, obtain weights from the manufacturer.
- Cast iron valve weights are for flanged end valves; steel weights for welding end valves.
- All flanged fitting, flanged valve and flange weights include the proportional weight of bolts or studs to make up all joints.

## Cast Iron & Steel Fittings – Line 1: Weight in Pounds, Line 2: Insulation Weight Factor

	Pressure Rating (PSI)									
	Cast Iron		Steel							
	125	250	150	300	400	600	900	1500	2500	
 Screwed or Slip On	<b>20</b> 1.5	<b>38</b> 1.5	<b>22</b> 1.5	<b>45</b> 1.5	<b>54</b> 1.5	<b>95</b> 1.5	<b>128</b> 1.5	<b>202</b> 1.5	<b>396</b> 1.5	
 Welding Neck			<b>27</b> 1.5	<b>48</b> 1.5	<b>67</b> 1.5	<b>96</b> 1.5	<b>130</b> 1.5	<b>202</b> 1.5	<b>451</b> 1.5	
 Lap Joint			<b>22</b> 1.5	<b>45</b> 1.5	<b>52</b> 1.5	<b>93</b> 1.5	<b>125</b> 1.5	<b>208</b> 1.5	<b>387</b> 1.5	
 Blind	<b>26</b> 1.5	<b>48</b> 1.5	<b>29</b> 1.5	<b>56</b> 1.5	<b>71</b> 1.5	<b>101</b> 1.5	<b>133</b> 1.5	<b>197</b> 1.5	<b>418</b> 1.5	
 S.R. 90° Elbow	<b>71</b> 4.3	<b>121</b> 4.4	<b>90</b> 4.3	<b>147</b> 4.4	<b>184</b> 4.6	<b>275</b> 4.8	<b>375</b> 5.0	<b>566</b> 5.3		
 L.R. 90° Elbow	<b>88</b> 4.9	<b>126</b> 4.9	<b>182</b> 4.9							
 45° Elbow	<b>63</b> 3.8	<b>111</b> 3.9	<b>82</b> 3.8	<b>132</b> 3.9	<b>149</b> 4.1	<b>240</b> 4.3	<b>320</b> 4.3	<b>476</b> 4.6		
 Tee	<b>108</b> 6.5	<b>186</b> 6.6	<b>149</b> 6.5	<b>218</b> 6.6	<b>279</b> 6.9	<b>400</b> 7.2	<b>565</b> 7.5	<b>839</b> 8.0		
 Flanged Bonnet Gate	<b>172</b> 7.3	<b>359</b> 8.0	<b>190</b> 4.3	<b>360</b> 5.0	<b>435</b> 5.5	<b>620</b> 5.8	<b>835</b> 6.0	<b>1595</b> 7.0		
 Flanged Bonnet - Globe or Angle	<b>184</b> 7.8	<b>345</b> 8.2	<b>185</b> 4.4	<b>275</b> 5.0	<b>415</b> 5.3	<b>645</b> 5.8	<b>765</b> 6.0	<b>1800</b> 7.0		
 Flanged Bonnet - Check	<b>154</b> 7.8	<b>286</b> 8.2	<b>150</b> 4.8	<b>200</b> 5.0	<b>360</b> 5.4	<b>445</b> 6.0	<b>800</b> 6.4	<b>1630</b> 7.0		
 Pressure Seal - Bonnet, Gate						<b>580</b> 3.5	<b>750</b> 4.0	<b>1215</b> 5.0		
 Pressure Seal - Bonnet, Globe							<b>730</b> 4.0	<b>780</b> 5.0		

## Pipe Insulation








Temp. Range -->	100 – 199	200 – 299	300 – 399	400 – 499	500 – 599	600 – 699	700 – 799	800 – 899	900 – 999	1,000 – 1,099	1,100 – 1,200
85% Magnesia Calcium Silicate	Nom. Thick., In. Lbs/Ft 1 2.11	1½ 3.28	2 4.57	2 4.57	2½ 6.09	3 7.60	3 7.60	3½ 9.82	3½ 9.82	4 11.5	4 11.4
Combination	Nom. Thick., In. Lbs/Ft					3 10.3	3 10.3	3½ 13.4	3½ 13.4	4 16.6	4 16.6

# Weight of Piping Materials – 8" PIPE (8.625" O.D.)

## Pipe

Sch./Wall Designation -->	5S	10S	20	30	40/Std.	60	80XS	100	120	140	160	
Thickness -- In.	0.109	0.148	0.219	0.250	0.277	0.322	0.406	0.500	0.593	0.718	0.812	0.906
Pipe -- Lbs/Ft.	9.91	13.4	19.64	22.36	24.7	28.55	35.64	43.4	50.9	60.6	67.8	74.7
Water -- Lbs/Ft	24.07	23.59	22.9	22.48	22.18	21.69	20.79	19.8	188	176	16.7	15.8














## Welded Fittings – Line 1: Weight in Pounds, Line 2: Insulation Weight Factor

 L.R. 90° Elbow	<b>15.4</b> 2.0	<b>21.0</b> 2.0		<b>44.9</b> 2.0	<b>70.3</b> 2.0			<b>120.0</b> 2.0				
 S.R. 90° Elbow	<b>6.6</b> 1.3	<b>14.3</b> 1.3		<b>34.5</b> 1.3	<b>50.2</b> 1.3							
 L.R. 45° Elbow	<b>8.1</b> 0.8	<b>11.0</b> 0.8		<b>22.8</b> 0.8	<b>32.8</b> 0.8			<b>56.0</b> 0.8				
 Tee	<b>18.4</b> 1.8	<b>25.0</b> 1.8		<b>60.2</b> 1.8	<b>78.0</b> 1.8			<b>120.0</b> 1.8				
 Lateral	<b>25.3</b> 3.8	<b>41.1</b> 3.8		<b>76.0</b> 3.8	<b>140.0</b> 3.8							
 Reducer	<b>4.5</b> 0.5	<b>7.8</b> 0.5		<b>13.9</b> 0.5	<b>20.4</b> 0.5			<b>32.1</b> 0.5				
 Cap	<b>2.1</b> 1.0	<b>2.8</b> 1.0		<b>11.3</b> 1.0	<b>16.3</b> 1.0			<b>32.0</b> 1.0				

**Note: Boldface black type** is weight in pounds and light grey type underneath is weight factor for insulation.

- Insulation thicknesses and weights are based on average conditions and do not constitute a recommendation for specific thicknesses of materials.
- Insulation weights are based on 85% magnesia and hydrous calcium silicate at 11 lbs/cu. foot. The listed thicknesses and weights of combination covering are the sums of the inner layer of diatomaceous earth at 21 lbs/cu. foot and the outer layer at 11 lbs/cubic foot.
- Insulation weights include allowances for wire, cement, canvas, bands and paint but not special surface finishes.
- To find the weight of covering on flanges, valves or fittings, multiply the weight factor by the weight per foot of covering used on straight pipe.
- Valve weights are approximate. Whenever possible, obtain weights from the manufacturer.
- Cast iron valve weights are for flanged end valves; steel weights for welding end valves.
- All flanged fitting, flanged valve and flange weights include the proportional weight of bolts or studs to make up all joints.

## Cast Iron & Steel Fittings – Line 1: Weight in Pounds, Line 2: Insulation Weight Factor

	Pressure Rating (PSI)									
	Cast Iron		Steel							
	125	250	150	300	400	600	900	1500	2500	
 Screwed or Slip On	<b>29</b> 1.5	<b>60</b> 1.5	<b>33</b> 1.5	<b>67</b> 1.5	<b>82</b> 1.5	<b>135</b> 1.5	<b>207</b> 1.5	<b>319</b> 1.5	<b>601</b> 1.5	
 Welding Neck			<b>42</b> 1.5	<b>76</b> 1.5	<b>104</b> 1.5	<b>137</b> 1.5	<b>222</b> 1.5	<b>334</b> 1.5	<b>692</b> 1.5	
 Lap Joint			<b>33</b> 1.5	<b>67</b> 1.5	<b>79</b> 1.5	<b>132</b> 1.5	<b>223</b> 1.5	<b>347</b> 1.5	<b>587</b> 1.5	
 Blind	<b>43</b> 1.5	<b>79</b> 1.5	<b>48</b> 1.5	<b>90</b> 1.5	<b>115</b> 1.5	<b>159</b> 1.5	<b>232</b> 1.5	<b>363</b> 1.5	<b>649</b> 1.5	
 S.R. 90° Elbow	<b>113</b> 4.5	<b>194</b> 4.7	<b>157</b> 4.5	<b>238</b> 4.7	<b>310</b> 5	<b>435</b> 5.2	<b>639</b> 5.4	<b>995</b> 5.7		
 L.R. 90° Elbow	<b>148</b> 5.3		<b>202</b> 5.3	<b>283</b> 5.3						
 45° Elbow	<b>97</b> 3.9	<b>164</b> 4.0	<b>127</b> 3.9	<b>203</b> 4.0	<b>215</b> 4.1	<b>360</b> 4.4	<b>507</b> 4.5	<b>870</b> 4.8		
 Tee	<b>168</b> 6.8	<b>289</b> 7.1	<b>230</b> 6.8	<b>337</b> 7.1	<b>445</b> 7.5	<b>610</b> 7.8	<b>978</b> 8.1	<b>1465</b> 8.6		
 Flanged Bonnet Gate	<b>251</b> 7.5	<b>583</b> 8.1	<b>305</b> 4.5	<b>505</b> 5.1	<b>730</b> 6.0	<b>960</b> 6.3	<b>1180</b> 6.6	<b>2740</b> 7.0		
 Flanged Bonnet - Globe or Angle	<b>317</b> 8.4	<b>554</b> 8.6	<b>475</b> 5.4	<b>505</b> 5.5	<b>610</b> 5.9	<b>1130</b> 6.3	<b>1160</b> 6.3	<b>2865</b> 7		
 Flanged Bonnet - Check	<b>302</b> 8.4	<b>454</b> 8.6	<b>235</b> 5.2	<b>310</b> 5.3	<b>475</b> 5.6	<b>725</b> 6	<b>1140</b> 6.4	<b>2075</b> 7		
 Pressure Seal - Bonnet, Gate						<b>925</b> 4.5	<b>1185</b> 4.7	<b>2345</b> 5.5		
 Pressure Seal - Bonnet, Globe							<b>1550</b> 4.0	<b>1680</b> 5.0		

## Pipe Insulation








Temp. Range -->	100 – 199	200 – 299	300 – 399	400 – 499	500 – 599	600 – 699	700 – 799	800 – 899	900 – 999	1,000 – 1,099	1,100 – 1,200
85% Magnesia Calcium Silicate	Nom. Thick., In. Lbs/Ft 1½ 4.13	1½ 4.13	2 5.64	2 5.64	2½ 7.85	3 9.48	3½ 11.5	3½ 11.5	4 13.8	4 13.8	4½ 16.0
Combination						3 12.9	3½ 16.2	3½ 16.2	4 20.4	4 20.4	4½ 23.8

# Weight of Piping Materials – 10" PIPE (10.750" O.D.)

## Pipe

Sch./Wall Designation -->	5S	10S	20	30	40/Std.	60/XS	80	100	120	140	160	
Thickness -- In.	0.134	0.165	0.219	0.250	0.307	0.365	0.500	0.593	0.718	0.843	1.000	1.125
Pipe -- Lbs/Ft.	15.15	18.7	24.63	28.04	34.24	40.5	54.7	64.3	76.9	89.2	104.1	115.7
Water -- Lbs/Ft	37.4	36.9	36.2	35.77	34.98	34.1	32.3	31.1	29.5	28.0	26.1	24.6














## Welded Fittings – Line 1: Weight in Pounds, Line 2: Insulation Weight Factor

 L.R. 90° Elbow	<b>29.2</b> 2.5	<b>36.0</b> 2.5			<b>84.0</b> 2.5	<b>112.0</b> 2.5					<b>230.0</b> 2.5
 S.R. 90° Elbow	<b>20.3</b> 1.7	<b>24.9</b> 1.7			<b>62.2</b> 1.7	<b>74</b> 1.7					
 L.R. 45° Elbow	<b>14.6</b> 1.0	<b>18.0</b> 1.0			<b>42.4</b> 1.0	<b>53.8</b> 1.0					<b>109.0</b> 1.0
 Tee	<b>30.0</b> 2.1	<b>37.0</b> 2.1			<b>104.0</b> 2.1	<b>132.0</b> 2.1					<b>222.0</b> 2.1
 Lateral	<b>47.5</b> 4.4	<b>70.0</b> 4.4			<b>124.0</b> 4.4	<b>200.0</b> 4.4					
 Reducer	<b>8.1</b> 0.6	<b>14.0</b> 0.6			<b>23.2</b> 0.6	<b>31.4</b> 0.6					<b>58.0</b> 0.6
 Cap	<b>3.8</b> 1.3	<b>4.7</b> 1.3			<b>20.0</b> 1.3	<b>26.3</b> 1.3					<b>59.0</b> 1.3

**Note: Boldface black type** is weight in pounds and **light grey type** underneath is weight factor for insulation.

- Insulation thicknesses and weights are based on average conditions and do not constitute a recommendation for specific thicknesses of materials.
- Insulation weights are based on 85% magnesia and hydrous calcium silicate at 11 lbs/cu. foot. The listed thicknesses and weights of combination covering are the sums of the inner layer of diatomaceous earth at 21 lbs/cu. foot and the outer layer at 11 lbs/cubic foot.
- Insulation weights include allowances for wire, cement, canvas, bands and paint but not special surface finishes.
- To find the weight of covering on flanges, valves or fittings, multiply the weight factor by the weight per foot of covering used on straight pipe.
- Valve weights are approximate. Whenever possible, obtain weights from the manufacturer.
- Cast iron valve weights are for flanged end valves; steel weights for welding end valves.
- All flanged fitting, flanged valve and flange weights include the proportional weight of bolts or studs to make up all joints.

## Cast Iron & Steel Fittings – Line 1: Weight in Pounds, Line 2: Insulation Weight Factor

	Pressure Rating (PSI)								
	Cast Iron				Steel				
	125	250	150	300	400	600	900	1500	2500
 Screwed or Slip On	<b>45</b> 1.5	<b>93</b> 1.5	<b>50</b> 1.5	<b>100</b> 1.5	<b>117</b> 1.5	<b>213</b> 1.5	<b>293</b> 1.5	<b>528</b> 1.5	<b>1148</b> 1.5
 Welding Neck			<b>59</b> 1.5	<b>110</b> 1.5	<b>152</b> 1.5	<b>225</b> 1.5	<b>316</b> 1.5	<b>546</b> 1.5	<b>1291</b> 1.5
 Lap Joint			<b>50</b> 1.5	<b>110</b> 1.5	<b>138</b> 1.5	<b>231</b> 1.5	<b>325</b> 1.5	<b>577</b> 1.5	<b>1120</b> 1.5
 Blind	<b>66</b> 1.5	<b>120</b> 1.5	<b>77</b> 1.5	<b>146</b> 1.5	<b>181</b> 1.5	<b>267</b> 1.5	<b>338</b> 1.5	<b>599</b> 1.5	<b>1248</b> 1.5
 S.R. 90° Elbow	<b>182</b> 4.8	<b>306</b> 4.9	<b>240</b> 4.8	<b>343</b> 4.9	<b>462</b> 5.2	<b>747</b> 5.6	<b>995</b> 5.8		
 L.R. 90° Elbow			<b>237</b> 5.8	<b>290</b> 5.8	<b>438</b> 5.8				
 45° Elbow	<b>152</b> 4.1	<b>256</b> 4.2	<b>185</b> 4.1	<b>288</b> 4.2	<b>332</b> 4.3	<b>572</b> 4.6	<b>732</b> 4.7		
 Tee	<b>277</b> 7.2	<b>446</b> 7.4	<b>353</b> 7.2	<b>527</b> 7.4	<b>578</b> 7.8	<b>1007</b> 8.4	<b>1417</b> 8.7		
 Flanged Bonnet Gate	<b>471</b> 7.7	<b>899</b> 8.3	<b>455</b> 4.5	<b>750</b> 5.0	<b>1035</b> 6	<b>1575</b> 6.9	<b>2140</b> 7.1	<b>3690</b> 8.0	
 Flanged Bonnet - Globe or Angle	<b>541</b> 9.1	<b>943</b> 9.1	<b>485</b> 4.5	<b>855</b> 5.5	<b>1070</b> 6.0	<b>1500</b> 6.3	<b>2500</b> 6.8	<b>4160</b> 8.0	
 Flanged Bonnet - Check	<b>453</b> 9.1	<b>751</b> 9.1	<b>370</b> 6.0	<b>485</b> 6.1	<b>605</b> 6.3	<b>1030</b> 6.8	<b>1350</b> 7.0	<b>2280</b> 7.5	
 Pressure Seal - Bonnet, Gate						<b>1450</b> 4.9	<b>1860</b> 5.5	<b>3150</b> 6.0	
 Pressure Seal - Bonnet, Globe							<b>1800</b> 5.0	<b>1910</b> 6.0	

## Pipe Insulation








Temp. Range -->	100 - 199	200 - 299	300 - 399	400 - 499	500 - 599	600 - 699	700 - 799	800 - 899	900 - 999	1,000 - 1,099	1,100 - 1,200
85% Magnesia Calcium Silicate	Nom. Thick., In. Lbs/Ft 1½ 5.2	1½ 5.2	2 7.07	2½ 8.93	2½ 8.93	3 11.0	3½ 13.2	3½ 13.2	4 15.5	4 15.5	4½ 18.1
Combination						3 15.4	3½ 19.3	3½ 19.3	4 23.0	4 23.0	4½ 27.2

# Weight of Pipng Materials – 12" PIPE (12.750" O.D.)

## Pipe

Sch./Wall Designation -->	5S	10S	20	30	Std.	40	XS	60	80	120	140	160
Thickness -- In.	0.156	0.18	0.250	0.33	0.375	0.406	0.500	0.562	0.687	1.000	1.125	1.312
Pipe -- Lbs/Ft.	20.99	24.2	33.38	43.8	49.6	53.5	65.4	73.2	88.5	125.5	139.7	160.3
Water -- Lbs/Ft	52.7	52.2	51.1	49.7	49.0	48.5	47.0	46.0	44.0	39.3	37.5	34.9














## Welded Fittings – Line 1: Weight in Pounds, Line 2: Insulation Weight Factor

 L.R. 90° Elbow	<b>51.2</b> 3.0	<b>57.0</b> 3.0		<b>122.0</b> 3.0	<b>156.0</b> 3.0							<b>375.0</b> 3.0
 S.R. 90° Elbow	<b>33.6</b> 2.0	<b>38.1</b> 2.0		<b>82.0</b> 2.0	<b>104.0</b> 2.0							
 L.R. 45° Elbow	<b>25.5</b> 1.3	<b>29.0</b> 1.3		<b>60.3</b> 1.3	<b>78.0</b> 1.3							<b>182.0</b> 1.3
 Tee	<b>46.7</b> 2.5	<b>54.0</b> 2.5		<b>162.0</b> 2.5	<b>180.0</b> 2.5							<b>360</b> 2.5
 Lateral	<b>74.7</b> 5.4	<b>86.2</b> 5.4		<b>180.0</b> 5.4	<b>273.0</b> 5.4							
 Reducer	<b>14.1</b> 0.7	<b>20.9</b> 0.7		<b>33.4</b> 0.7	<b>43.6</b> 0.7							<b>94.0</b> 0.7
 Cap	<b>6.2</b> 1.5	<b>7.1</b> 1.5		<b>29.5</b> 1.5	<b>38.1</b> 1.5							<b>95.0</b> 1.5

**Note: Boldface black type** is weight in pounds and **light grey type** underneath is weight factor for insulation.

- Insulation thicknesses and weights are based on average conditions and do not constitute a recommendation for specific thicknesses of materials.
- Insulation weights are based on 85% magnesia and hydrous calcium silicate at 11 lbs/cu. foot. The listed thicknesses and weights of combination covering are the sums of the inner layer of diatomaceous earth at 21 lbs/cu. foot and the outer layer at 11 lbs/cubic foot.
- Insulation weights include allowances for wire, cement, canvas, bands and paint but not special surface finishes.
- To find the weight of covering on flanges, valves or fittings, multiply the weight factor by the weight per foot of covering used on straight pipe.
- Valve weights are approximate. Whenever possible, obtain weights from the manufacturer.
- Cast iron valve weights are for flanged end valves; steel weights for welding end valves.
- All flanged fitting, flanged valve and flange weights include the proportional weight of bolts or studs to make up all joints.

## Cast Iron & Steel Fittings – Line 1: Weight in Pounds, Line 2: Insulation Weight Factor

	Pressure Rating (PSI)									
	Cast Iron		Steel							
	125	250	150	300	400	600	900	1500	2500	
 Screwed or Slip On	<b>58</b> 1.5	<b>123</b> 1.5	<b>71</b> 1.5	<b>140</b> 1.5	<b>164</b> 1.5	<b>261</b> 1.5	<b>388</b> 1.5	<b>820</b> 1.5	<b>1611</b> 1.5	
 Welding Neck			<b>87</b> 1.5	<b>163</b> 1.5	<b>212</b> 1.5	<b>272</b> 1.5	<b>434</b> 1.5	<b>843</b> 1.5	<b>1919</b> 1.5	
 Lap Joint			<b>71</b> 1.5	<b>164</b> 1.5	<b>187</b> 1.5	<b>286</b> 1.5	<b>433</b> 1.5	<b>902</b> 1.5	<b>1573</b> 1.5	
 Blind	<b>95</b> 1.5	<b>165</b> 1.5	<b>117</b> 1.5	<b>209</b> 1.5	<b>261</b> 1.5	<b>341</b> 1.5	<b>475</b> 1.5	<b>928</b> 1.5	<b>1775</b> 1.5	
 S.R. 90° Elbow	<b>257</b> 5.0	<b>430</b> 5.2	<b>345</b> 5.0	<b>509</b> 5.2	<b>669</b> 5.5	<b>815</b> 5.8	<b>1474</b> 6.2			
 L.R. 90° Elbow	<b>357</b> 6.2	<b>485</b> 6.2	<b>624</b> 6.2				<b>1598</b> 6.2			
 45° Elbow	<b>227</b> 4.3	<b>360</b> 4.3	<b>282</b> 4.3	<b>414</b> 4.3	<b>469</b> 4.5	<b>705</b> 4.7	<b>1124</b> 4.8			
 Tee	<b>387</b> 7.5	<b>640</b> 7.8	<b>513</b> 7.5	<b>754</b> 7.8	<b>943</b> 8.3	<b>1361</b> 8.7	<b>1928</b> 9.3			
 Flanged Bonnet Gate	<b>687</b> 7.8	<b>1298</b> 8.5	<b>635</b> 4.0	<b>1015</b> 5.0	<b>1420</b> 5.5	<b>2155</b> 7.0	<b>2770</b> 7.2	<b>4650</b> 8.0		
 Flanged Bonnet - Globe or Angle	<b>808</b> 9.4	<b>1200</b> 9.5	<b>710</b> 5.0	<b>1410</b> 5.5						
 Flanged Bonnet - Check	<b>674</b> 9.4	<b>1160</b> 9.5	<b>560</b> 6.0	<b>720</b> 6.5		<b>1410</b> 7.2	<b>2600</b> 8.0	<b>3370</b> 8.0		
 Pressure Seal - Bonnet, Gate						<b>1975</b> 5.5	<b>2560</b> 6.0	<b>4515</b> 7.0		
 Pressure Seal - Bonnet, Globe										

## Pipe Insulation







Temp. Range -->	100 – 199	200 – 299	300 – 399	400 – 499	500 – 599	600 – 699	700 – 799	800 – 899	900 – 999	1,000 – 1,099	1,100 – 1,200
85% Magnesia Calcium Silicate	Nom. Thick., In. Lbs/Ft 1½ 6.04	1½ 6.04	2 8.13	2½ 10.5	3 12.7	3 12.7	3½ 15.1	4 17.9	4 17.9	4½ 20.4	4½ 20.4
Combination	Nom. Thick., In. Lbs/Ft					3 17.7	3½ 21.9	4 26.7	4 26.7	4½ 31.1	4½ 31.1

# Weight of Piping Materials – 14" PIPE (14" O.D.)

## Pipe

Sch./Wall Designation -->	5S	10S	10	20	30/Std.	40	XS	60XS	80	120	140	160
Thickness -- In.	0.156	0.188	0.250	0.312	0.375	0.438	0.500	0.593	0.75	1.093	1.25	1.406
Pipe -- Lbs/Ft.	23.0	27.7	36.71	45.7	54.6	63.4	72.1	84.9	106.1	150.7	170.2	189.1
Water -- Lbs/Ft	63.7	63.1	62.06	60.92	59.7	58.7	57.5	55.9	53.2	47.5	45.0	42.6














## Welded Fittings – Line 1: Weight in Pounds, Line 2: Insulation Weight Factor

 L.R. 90° Elbow	<b>65.6</b> 3.5	<b>78.0</b> 3.5		<b>157.0</b> 3.5	<b>200.0</b> 3.5
 S.R. 90° Elbow	<b>43.1</b> 2.3	<b>51.7</b> 2.3		<b>108.0</b> 2.3	<b>135.0</b> 2.3
 L.R. 45° Elbow	<b>32.5</b> 1.5	<b>39.4</b> 1.5		<b>80.0</b> 1.5	<b>98.0</b> 1.5
 Tee	<b>49.4</b> 2.8	<b>59.6</b> 2.8		<b>196.0</b> 2.8	<b>220.0</b> 2.8
 Lateral	<b>94.4</b> 5.8	<b>113.0</b> 5.8		<b>218.0</b> 5.8	<b>340.0</b> 5.8
 Reducer	<b>25.0</b> 1.1	<b>31.2</b> 1.1		<b>63.0</b> 1.1	<b>83.0</b> 1.1
 Cap	<b>7.6</b> 1.7	<b>9.2</b> 1.7		<b>35.3</b> 1.7	<b>45.9</b> 1.7

**Note: Boldface black type** is weight in pounds and **light grey type** underneath is weight factor for insulation.

- Insulation thicknesses and weights are based on average conditions and do not constitute a recommendation for specific thicknesses of materials.
- Insulation weights are based on 85% magnesia and hydrous calcium silicate at 11 lbs/cu. foot. The listed thicknesses and weights of combination covering are the sums of the inner layer of diatomaceous earth at 21 lbs/cu. foot and the outer layer at 11 lbs/cubic foot.
- Insulation weights include allowances for wire, cement, canvas, bands and paint but not special surface finishes.
- To find the weight of covering on flanges, valves or fittings, multiply the weight factor by the weight per foot of covering used on straight pipe.
- Valve weights are approximate. Whenever possible, obtain weights from the manufacturer.
- Cast iron valve weights are for flanged end valves; steel weights for welding end valves.
- All flanged fitting, flanged valve and flange weights include the proportional weight of bolts or studs to make up all joints.

## Cast Iron & Steel Fittings – Line 1: Weight in Pounds, Line 2: Insulation Weight Factor

	Pressure Rating (PSI)									
	Cast Iron		Steel							
	125	250	150	300	400	600	900	1500	2500	
 Screwed or Slip On	<b>90</b> 1.5	<b>184</b> 1.5	<b>95</b> 1.5	<b>195</b> 1.5	<b>235</b> 1.5	<b>318</b> 1.5	<b>460</b> 1.5	<b>1060</b> 1.5		
 Welding Neck			<b>130</b> 1.5	<b>217</b> 1.5	<b>277</b> 1.5	<b>406</b> 1.5	<b>642</b> 1.5	<b>1241</b> 1.5		
 Lap Joint			<b>119</b> 1.5	<b>220</b> 1.5	<b>254</b> 1.5	<b>349</b> 1.5	<b>477</b> 1.5	<b>1076</b> 1.5		
 Blind	<b>125</b> 1.5	<b>239</b> 1.5	<b>141</b> 1.5	<b>267</b> 1.5	<b>354</b> 1.5	<b>437</b> 1.5	<b>574</b> 1.5			
 S.R. 90° Elbow	<b>360</b> 5.3	<b>617</b> 5.5	<b>497</b> 5.3	<b>632</b> 5.5	<b>664</b> 5.7	<b>918</b> 5.9	<b>1549</b> 6.4			
 L.R. 90° Elbow	<b>480</b> 6.6	<b>767</b> 6.6	<b>622</b> 6.6	<b>772</b> 6.6						
 45° Elbow	<b>280</b> 4.3	<b>497</b> 4.4	<b>377</b> 4.3	<b>587</b> 4.4	<b>638</b> 4.6	<b>883</b> 4.8	<b>1246</b> 4.9			
 Tee	<b>540</b> 8.0	<b>956</b> 8.4	<b>683</b> 8.0	<b>968</b> 8.3	<b>1131</b> 8.6	<b>1652</b> 8.9	<b>2318</b> 9.6			
 Flanged Bonnet Gate	<b>921</b> 7.9	<b>1762</b> 8.8	<b>905</b> 4.9	<b>1525</b> 6.0	<b>1920</b> 6.3	<b>2960</b> 7.0	<b>4170</b> 8.0	<b>6425</b> 8.8		
 Flanged Bonnet – Globe or Angle	<b>1171</b> 9.9									
 Flanged Bonnet – Check	<b>885</b> 9.9		<b>1010</b> 5.0	<b>1155</b> 5.2						
 Pressure Seal – Bonnet, Gate							<b>2620</b> 6.0	<b>3475</b> 6.5	<b>6380</b> 7.5	
 Pressure Seal – Bonnet, Globe										

## Pipe Insulation








Temp. Range -->	100 – 199	200 – 299	300 – 399	400 – 499	500 – 599	600 – 699	700 – 799	800 – 899	900 – 999	1,000 – 1,099	1,100 – 1,200
85% Magnesia Calcium Silicate	Nom. Thick., In. Lbs/Ft 1½ 6.16	1½ 6.16	2 8.38	2½ 10.7	3 13.1	3 13.1	3½ 15.8	4 18.5	4 18.5	4½ 21.3	4½ 21.3
Combination						3 18.2	3½ 22.8	4 27.5	4 27.5	4½ 32.4	4½ 32.4

# Weight of Piping Materials – 16" PIPE (16" O.D.)

## Pipe

Sch./Wall Designation -->	5S	10S	10	20	30/Std.	40XS	60	80	100	120	140	160
Thickness -- In.	0.165	0.188	0.250	0.312	0.375	0.500	0.656	0.843	1.031	1.218	1.438	1.593
Pipe -- Lbs/Ft.	28.0	32.0	42.1	52.4	62.6	82.8	107.5	136.5	164.8	192.3	223.6	245.1
Water -- Lbs/Ft	83.5	83.0	81.8	80.5	79.1	76.5	73.4	69.7	66.1	62.6	58.6	55.9














## Welded Fittings – Line 1: Weight in Pounds, Line 2: Insulation Weight Factor

 L.R. 90° Elbow	<b>89.8</b> 4.0	<b>102.0</b> 4.0		<b>208.0</b> 4.0	<b>270.0</b> 4.0
 S.R. 90° Elbow	<b>59.7</b> 2.5	<b>67.7</b> 2.5		<b>135.0</b> 2.5	<b>177.0</b> 2.5
 L.R. 45° Elbow	<b>44.9</b> 1.7	<b>51.0</b> 1.7		<b>104.0</b> 1.7	<b>136.0</b> 1.7
 Tee	<b>66.8</b> 3.2	<b>75.9</b> 3.2		<b>250.0</b> 3.2	<b>278.0</b> 3.2
 Lateral	<b>127.0</b> 6.7	<b>144.0</b> 6.7		<b>275.0</b> 6.7	<b>431.0</b> 6.7
 Reducer	<b>31.3</b> 1.2	<b>35.7</b> 1.2		<b>77.0</b> 1.2	<b>102.0</b> 1.2
 Cap	<b>10.1</b> 1.8	<b>11.5</b> 1.8		<b>44.3</b> 1.8	<b>57.0</b> 1.8

**Note: Boldface black type** is weight in pounds and light grey type underneath is weight factor for insulation.

- Insulation thicknesses and weights are based on average conditions and do not constitute a recommendation for specific thicknesses of materials.
- Insulation weights are based on 85% magnesia and hydrous calcium silicate at 11 lbs/cu. foot. The listed thicknesses and weights of combination covering are the sums of the inner layer of diatomaceous earth at 21 lbs/cu. foot and the outer layer at 11 lbs/cubic foot.
- Insulation weights include allowances for wire, cement, canvas, bands and paint but not special surface finishes.
- To find the weight of covering on flanges, valves or fittings, multiply the weight factor by the weight per foot of covering used on straight pipe.
- Valve weights are approximate. Whenever possible, obtain weights from the manufacturer.
- Cast iron valve weights are for flanged end valves; steel weights for welding end valves.
- All flanged fitting, flanged valve and flange weights include the proportional weight of bolts or studs to make up all joints.

## Cast Iron & Steel Fittings – Line 1: Weight in Pounds, Line 2: Insulation Weight Factor

	Pressure Rating (PSI)									
	Cast Iron		Steel							
	125	250	150	300	400	600	900	1500	2500	
 Screwed or Slip On	<b>114</b> 1.5	<b>233</b> 1.5	<b>107</b> 1.5	<b>262</b> 1.5	<b>310</b> 1.5	<b>442</b> 1.5	<b>559</b> 1.5	<b>1297</b> 1.5		
 Welding Neck			<b>141</b> 1.5	<b>288</b> 1.5	<b>351</b> 1.5	<b>577</b> 1.5	<b>785</b> 1.5	<b>1597</b> 1.5		
 Lap Joint			<b>142</b> 1.5	<b>282</b> 1.5	<b>337</b> 1.5	<b>476</b> 1.5	<b>588</b> 1.5	<b>1372</b> 1.5		
 Blind	<b>174</b> 1.5	<b>308</b> 1.5	<b>184</b> 1.5	<b>349</b> 1.5	<b>455</b> 1.5	<b>603</b> 1.5	<b>719</b> 1.5			
 S.R. 90° Elbow	<b>484</b> 5.5	<b>826</b> 5.8	<b>656</b> 5.5	<b>958</b> 5.8	<b>1014</b> 6.0	<b>1402</b> 6.3	<b>1886</b> 6.7			
 L.R. 90° Elbow	<b>684</b> 7.0	<b>1036</b> 7.0	<b>781</b> 7.0	<b>1058</b> 7.0						
 45° Elbow	<b>374</b> 4.3	<b>696</b> 4.6	<b>481</b> 4.3	<b>708</b> 4.6	<b>839</b> 4.7	<b>1212</b> 5.0	<b>1586</b> 5.0			
 Tee	<b>714</b> 8.3	<b>1263</b> 8.7	<b>961</b> 8.3	<b>1404</b> 8.6	<b>1671</b> 9.0	<b>2128</b> 9.4	<b>3054</b> 10.0			
 Flanged Bonnet Gate	<b>1254</b> 8.0	<b>2321</b> 9.0	<b>1190</b> 5.0	<b>2015</b> 7.0	<b>2300</b> 7.2	<b>3675</b> 7.9	<b>4950</b> 8.2	<b>7875</b> 9.0		
 Flanged Bonnet – Globe or Angle										
 Flanged Bonnet – Check	<b>1166</b> 10.5			<b>1225</b> 6.0						
 Pressure Seal – Bonnet, Gate						<b>3230</b> 7.0	<b>8130</b> 8.0			
 Pressure Seal – Bonnet, Globe										

## Pipe Insulation








Temp. Range -->	100 – 199	200 – 299	300 – 399	400 – 499	500 – 599	600 – 699	700 – 799	800 – 899	900 – 999	1,000 – 1,099	1,100 – 1,200
85% Magnesia Calcium Silicate	Nom. Thick., In. Lbs/Ft 1½ 6.9	1½ 6.9	2 9.33	2½ 12.0	3 14.6	3 14.6	3½ 17.5	4 20.5	4 20.5	4½ 23.6	4½ 23.6
Combination						3 20.3	3½ 25.2	4 30.7	4 30.7	4½ 36.0	4½ 36.0

# Weight of Piping Materials – 18" PIPE (18" O.D.)

## Pipe

Sch./Wall Designation -->	5S	10S	10	20	Std.	30	XS	40	60	80	120	160
Thickness -- In.	0.165	0.188	0.25	0.312	0.375	0.438	0.500	0.562	0.75	0.937	1.375	1.781
Pipe -- Lbs/Ft.	31.0	36.0	47.4	59.0	70.6	82.1	93.5	104.8	138.2	170.8	244.1	308.5
Water -- Lbs/Ft	106.2	105.7	104.3	102.8	101.2	99.9	98.4	97.0	92.7	88.5	79.2	71.0














## Welded Fittings – Line 1: Weight in Pounds, Line 2: Insulation Weight Factor

 L.R. 90° Elbow	<b>114.0</b> 4.5	<b>129.0</b> 4.5	<b>256.0</b> 4.5	<b>332.0</b> 4.5
 S.R. 90° Elbow	<b>75.7</b> 2.8	<b>85.7</b> 2.8	<b>176.0</b> 2.8	<b>225.0</b> 2.8
 L.R. 45° Elbow	<b>57.2</b> 1.9	<b>64.5</b> 1.9	<b>132.0</b> 1.9	<b>168.0</b> 1.9
 Tee	<b>83.2</b> 3.6	<b>94.7</b> 3.6	<b>282.0</b> 3.6	<b>351.0</b> 3.6
 Lateral	<b>157.0</b> 7.5	<b>179.0</b> 7.5	<b>326.0</b> 7.5	<b>525.0</b> 7.5
 Reducer	<b>42.6</b> 1.3	<b>48.5</b> 1.3	<b>94.0</b> 1.3	<b>123.0</b> 1.3
 Cap	<b>12.7</b> 2.1	<b>14.5</b> 2.1	<b>57.0</b> 2.1	<b>75.0</b> 2.1

**Note: Boldface black type** is weight in pounds and **light grey type** underneath is weight factor for insulation.

- Insulation thicknesses and weights are based on average conditions and do not constitute a recommendation for specific thicknesses of materials.
- Insulation weights are based on 85% magnesia and hydrous calcium silicate at 11 lbs/cu. foot. The listed thicknesses and weights of combination covering are the sums of the inner layer of diatomaceous earth at 21 lbs/cu. foot and the outer layer at 11 lbs/cubic foot.
- Insulation weights include allowances for wire, cement, canvas, bands and paint but not special surface finishes.
- To find the weight of covering on flanges, valves or fittings, multiply the weight factor by the weight per foot of covering used on straight pipe.
- Valve weights are approximate. Whenever possible, obtain weights from the manufacturer.
- Cast iron valve weights are for flanged end valves; steel weights for welding end valves.
- All flanged fitting, flanged valve and flange weights include the proportional weight of bolts or studs to make up all joints.

## Cast Iron & Steel Fittings – Line 1: Weight in Pounds, Line 2: Insulation Weight Factor

	Pressure Rating (PSI)									
	Cast Iron					Steel				
	125	250	150	300	400	600	900	1500	2500	
 Screwed or Slip On	<b>125</b> 1.5	<b>139</b> 1.5	<b>331</b> 1.5	<b>380</b> 1.5	<b>573</b> 1.5	<b>797</b> 1.5	<b>1694</b> 1.5			
 Welding Neck			<b>159</b> 1.5	<b>355</b> 1.5	<b>430</b> 1.5	<b>652</b> 1.5	<b>1074</b> 1.5	<b>2069</b> 1.5		
 Lap Joint			<b>165</b> 1.5	<b>415</b> 1.5	<b>566</b> 1.5	<b>820</b> 1.5	<b>1769</b> 1.5			
 Blind	<b>209</b> 1.5	<b>396</b> 1.5	<b>228</b> 1.5	<b>440</b> 1.5	<b>572</b> 1.5	<b>762</b> 1.5	<b>1030</b> 1.5			
 S.R. 90° Elbow	<b>599</b> 5.8	<b>1060</b> 6.0	<b>711</b> 5.8	<b>1126</b> 6.0	<b>1340</b> 6.2	<b>1793</b> 6.6	<b>2817</b> 7.0			
 L.R. 90° Elbow			<b>1350</b> 7.4	<b>941</b> 7.4	<b>1426</b> 7.4					
 45° Elbow	<b>439</b> 4.4	<b>870</b> 4.7	<b>521</b> 4.4	<b>901</b> 4.7	<b>1040</b> 4.8	<b>1543</b> 5	<b>2252</b> 5.2			
 Tee	<b>879</b> 8.6	<b>1625</b> 9.0	<b>1010</b> 8.6	<b>1602</b> 9.0	<b>1909</b> 9.0	<b>2690</b> 9.9	<b>4327</b> 10.5			
 Flanged Bonnet Gate	<b>1629</b> 8.2	<b>2578</b> 9.3	<b>1510</b> 6.0	<b>2505</b> 6.5	<b>3765</b> 7.0	<b>4460</b> 7.8	<b>6675</b> 8.5			
 Flanged Bonnet - Globe or Angle										
 Flanged Bonnet - Check	<b>1371</b> 10.5									
 Pressure Seal - Bonnet, Gate								<b>3100</b> 5.5	<b>3400</b> 5.6	<b>4200</b> 6.0
 Pressure Seal - Bonnet, Globe										

## Pipe Insulation








Temp. Range -->	100 - 199	200 - 299	300 - 399	400 - 499	500 - 599	600 - 699	700 - 799	800 - 899	900 - 999	1,000 - 1,099	1,100 - 1,200
85% Magnesia Calcium Silicate	Nom. Thick., In. Lbs/Ft 1½ 7.73	1½ 7.73	2 10.4	2½ 13.3	3 16.3	3 16.3	3½ 19.3	4 22.6	4 22.6	4½ 25.9	4½ 25.9
Combination						3 22.7	3½ 28.0	4 33.8	4 33.8	4½ 39.5	4½ 39.5

# Weight of Piping Materials – 20" PIPE (20" O.D.)

## Pipe

Sch./Wall Designation -->	5S	10S	10	20/Std.	30/XS	40	60	80	100	120	140	160
Thickness -- In.	0.188	0.218	0.250	0.375	0.500	0.593	0.812	1.031	1.281	1.500	1.750	1.968
Pipe -- Lbs/Ft.	40.0	46.0	52.7	78.6	104.1	122.9	166.4	208.9	256.1	296.4	341.1	379
Water -- Lbs/Ft	131.0	130.2	129.5	126.0	122.8	120.4	115.0	109.4	103.4	98.3	92.6	87.9














## Welded Fittings – Line 1: Weight in Pounds, Line 2: Insulation Weight Factor

 L.R. 90° Elbow	<b>160.0</b> 5.0	<b>185.0</b> 5.0	<b>322.0</b> 5.0	<b>438.0</b> 5.0
 S.R. 90° Elbow	<b>106.0</b> 3.4	<b>122.0</b> 3.4	<b>238.0</b> 3.4	<b>278.0</b> 3.4
 L.R. 45° Elbow	<b>80.3</b> 2.1	<b>92.5</b> 2.1	<b>160.0</b> 2.1	<b>228.0</b> 2.1
 Tee	<b>112.0</b> 4.0	<b>130.0</b> 4.0	<b>378.0</b> 4.0	<b>490.0</b> 4.0
 Lateral	<b>228.0</b> 8.3	<b>265.0</b> 8.3	<b>396.0</b> 8.3	<b>625.0</b> 8.3
 Reducer	<b>71.6</b> 1.7	<b>87.6</b> 1.7	<b>142.0</b> 1.7	<b>186.0</b> 1.7
 Cap	<b>17.7</b> 2.3	<b>20.5</b> 2.3	<b>71.0</b> 2.3	<b>93.0</b> 2.3

**Note: Boldface black type** is weight in pounds and light grey type underneath is weight factor for insulation.

- Insulation thicknesses and weights are based on average conditions and do not constitute a recommendation for specific thicknesses of materials.
- Insulation weights are based on 85% magnesia and hydrous calcium silicate at 11 lbs/cu. foot. The listed thicknesses and weights of combination covering are the sums of the inner layer of diatomaceous earth at 21 lbs/cu. foot and the outer layer at 11 lbs/cubic foot.
- Insulation weights include allowances for wire, cement, canvas, bands and paint but not special surface finishes.
- To find the weight of covering on flanges, valves or fittings, multiply the weight factor by the weight per foot of covering used on straight pipe.
- Valve weights are approximate. Whenever possible, obtain weights from the manufacturer.
- Cast iron valve weights are for flanged end valves; steel weights for welding end valves.
- All flanged fitting, flanged valve and flange weights include the proportional weight of bolts or studs to make up all joints.

## Cast Iron & Steel Fittings – Line 1: Weight in Pounds, Line 2: Insulation Weight Factor

	Pressure Rating (PSI)									
	Cast Iron		Steel							
	125	250	150	300	400	600	900	1500	2500	
 Screwed or Slip On	<b>153</b> 1.5		<b>180</b> 1.5	<b>378</b> 1.5	<b>468</b> 1.5	<b>733</b> 1.5	<b>972</b> 1.5	<b>2114</b> 1.5		
 Welding Neck			<b>195</b> 1.5	<b>431</b> 1.5	<b>535</b> 1.5	<b>811</b> 1.5	<b>1344</b> 1.5	<b>2614</b> 1.5		
 Lap Joint			<b>210</b> 1.5	<b>428</b> 1.5	<b>510</b> 1.5	<b>725</b> 1.5	<b>1048</b> 1.5	<b>2189</b> 1.5		
 Blind	<b>275</b> 1.5	<b>487</b> 1.5	<b>297</b> 1.5	<b>545</b> 1.5	<b>711</b> 1.5	<b>976</b> 1.5	<b>1287</b> 1.5			
 S.R. 90° Elbow	<b>792</b> 6.0	<b>1315</b> 6.3	<b>922</b> 6.0	<b>1375</b> 6.3	<b>1680</b> 6.5	<b>2314</b> 6.9	<b>3610</b> 7.3			
 L.R. 90° Elbow	<b>1132</b> 7.8	<b>1725</b> 7.8	<b>1352</b> 7.8	<b>1705</b> 7.8						
 45° Elbow	<b>592</b> 4.6	<b>1055</b> 4.8	<b>652</b> 4.6	<b>1105</b> 4.8	<b>1330</b> 4.9	<b>1917</b> 5.2	<b>2848</b> 5.4			
 Tee	<b>1178</b> 9.0	<b>2022</b> 9.5	<b>1378</b> 9.0	<b>1908</b> 9.5	<b>2370</b> 9.7	<b>3463</b> 10.1	<b>5520</b> 11.0			
 Flanged Bonnet Gate	<b>1934</b> 8.3	<b>3823</b> 9.5	<b>1855</b> 6.0	<b>3370</b> 7.0	<b>5700</b> 8.0	<b>5755</b> 8.0				
 Flanged Bonnet - Globe or Angle										
 Flanged Bonnet - Check	<b>1772</b> 11.0									
 Pressure Seal - Bonnet, Gate										
 Pressure Seal - Bonnet, Globe										

## Pipe Insulation








Temp. Range -->	100 – 199	200 – 299	300 – 399	400 – 499	500 – 599	600 – 699	700 – 799	800 – 899	900 – 999	1,000 – 1,099	1,100 – 1,200
85% Magnesia Calcium Silicate	Nom. Thick., In. Lbs/Ft 1½ 8.45	1½ 8.45	2 11.6	2½ 14.6	3 17.7	3 17.7	3½ 21.1	4 24.6	4 24.6	4½ 28.1	4½ 28.1
Combination	Nom. Thick., In. Lbs/Ft					3 24.7	3½ 30.7	4 37.0	4 37.0	4½ 43.1	4½ 43.1

# Weight of Piping Materials – 24" PIPE (24" O.D.)

## Pipe

Sch./Wall Designation -->	5S	10	20/Std.	XS	30	40	60	80	100	140	160
Thickness -- In.	0.218	0.250	0.375	0.500	0.562	0.687	0.968	1.218	1.812	2.062	2.343
Pipe -- Lbs/Ft.	55.0	63.4	94.6	125.5	140.8	171.2	238.1	296.4	429.4	483.1	541.9
Water -- Lbs/Ft	188.9	188.0	183.8	180.1	178.1	174.3	165.8	158.3	141.4	134.5	127.0














## Welded Fittings – Line 1: Weight in Pounds, Line 2: Insulation Weight Factor

 L.R. 90° Elbow	<b>260.0</b> 6.0	<b>500.0</b> 6.0	<b>578.0</b> 6.0
 S.R. 90° Elbow	<b>178.0</b> 3.7	<b>304.0</b> 3.7	<b>404.0</b> 3.7
 L.R. 45° Elbow	<b>130.0</b> 2.5	<b>252.0</b> 2.5	<b>292.0</b> 2.5
 Tee	<b>174.0</b> 4.9	<b>544.0</b> 4.9	<b>607.0</b> 4.9
 Lateral	<b>361.0</b> 10.0	<b>544.0</b> 10.0	<b>875.0</b> 10.0
 Reducer	<b>107.0</b> 1.7	<b>167.0</b> 1.7	<b>220</b> 1.7
 Cap	<b>28.6</b> 2.8	<b>102.0</b> 2.8	<b>134.0</b> 2.8

**Note: Boldface black type** is weight in pounds and **light grey type** underneath is weight factor for insulation.

- Insulation thicknesses and weights are based on average conditions and do not constitute a recommendation for specific thicknesses of materials.
- Insulation weights are based on 85% magnesia and hydrous calcium silicate at 11 lbs/cu. foot. The listed thicknesses and weights of combination covering are the sums of the inner layer of diatomaceous earth at 21 lbs/cu. foot and the outer layer at 11 lbs/cubic foot.
- Insulation weights include allowances for wire, cement, canvas, bands and paint but not special surface finishes.
- To find the weight of covering on flanges, valves or fittings, multiply the weight factor by the weight per foot of covering used on straight pipe.
- Valve weights are approximate. Whenever possible, obtain weights from the manufacturer.
- Cast iron valve weights are for flanged end valves; steel weights for welding end valves.
- All flanged fitting, flanged valve and flange weights include the proportional weight of bolts or studs to make up all joints.

## Cast Iron & Steel Fittings – Line 1: Weight in Pounds, Line 2: Insulation Weight Factor

	Pressure Rating (PSI)								
	Cast Iron				Steel				
	125	250	150	300	400	600	900	1500	2500
 Screwed or Slip On	<b>236</b> 1.5	<b>245</b> 1.5	<b>577</b> 1.5	<b>676</b> 1.5	<b>1056</b> 1.5	<b>1823</b> 1.5	<b>3378</b> 1.5		
 Welding Neck			<b>295</b> 1.5	<b>632</b> 1.5	<b>777</b> 1.5	<b>1157</b> 1.5	<b>2450</b> 1.5	<b>4153</b> 1.5	
 Lap Joint				<b>295</b> 1.5	<b>617</b> 1.5	<b>752</b> 1.5	<b>1046</b> 1.5	<b>2002</b> 1.5	<b>3478</b> 1.5
 Blind	<b>404</b> 1.5	<b>757</b> 1.5	<b>446</b> 1.5	<b>841</b> 1.5	<b>1073</b> 1.5	<b>1355</b> 1.5	<b>2442</b> 1.5		
 S.R. 90° Elbow	<b>1231</b> 6.7	<b>2014</b> 6.8	<b>1671</b> 6.7	<b>2174</b> 6.8	<b>2474</b> 7.1	<b>3506</b> 7.6	<b>6155</b> 8.1		
 L.R. 90° Elbow	<b>1711</b> 8.7	<b>2644</b> 8.7	<b>1821</b> 8.7	<b>2874</b> 8.7					
 45° Elbow	<b>871</b> 4.8	<b>1604</b> 5.0	<b>1121</b> 4.8	<b>1634</b> 5	<b>1974</b> 5.1	<b>2831</b> 5.5	<b>5124</b> 6.0		
 Tee	<b>1836</b> 10.0	<b>3061</b> 10.2	<b>2276</b> 10.0	<b>3161</b> 10.2	<b>3811</b> 10.6	<b>5184</b> 11.4	<b>9387</b> 12.1		
 Flanged Bonnet Gate	<b>3062</b> 8.5	<b>6484</b> 9.8	<b>2500</b> 5.0	<b>4675</b> 7.0	<b>6995</b> 8.7	<b>8020</b> 9.5			
 Flanged Bonnet - Globe or Angle									
 Flanged Bonnet - Check	<b>2956</b> 12.0								
 Pressure Seal - Bonnet, Gate									
 Pressure Seal - Bonnet, Globe									

## Pipe Insulation








Temp. Range -->	100 – 199	200 – 299	300 – 399	400 – 499	500 – 599	600 – 699	700 – 799	800 – 899	900 – 999	1,000 – 1,099	1,100 – 1,200
85% Magnesia Calcium Silicate	Nom. Thick., In. 10.0	1½ 10.0	2 13.4	2½ 17.0	3 21.0	3 21.0	3½ 24.8	4 28.7	4 28.7	4½ 32.9	4½ 32.9
Combination	Nom. Thick., In. Lbs/Ft					3 29.2	3½ 36	4 43.1	4 43.1	4½ 50.6	4½ 50.6

# Weight of Piping Materials – 26" PIPE (26" O.D.)

## Pipe

Sch./Wall Designation -->	10	Std.	20/XS						
Thickness -- In.	0.250	0.312	0.375	0.500	0.625	0.750	0.875	1.000	1.125
Pipe -- Lbs/Ft.	670.0	85.7	102.6	136.2	169.0	202.0	235.0	267.0	299.0
Water -- Lbs/Ft	221.4	219.2	216.8	212.5	208.6	204.4	200.2	196.1	192.10














## Welded Fittings – Line 1: Weight in Pounds, Line 2: Insulation Weight Factor

 L.R. 90° Elbow	<b>602.0</b> 8.5	<b>713.0</b> 8.5
 S.R. 90° Elbow	<b>359.0</b> 5.0	<b>474.0</b> 5.0
 L.R. 45° Elbow	<b>269.0</b> 3.5	<b>355.0</b> 3.5
 Tee	<b>634.0</b> 6.8	<b>794.0</b> 6.8
 Lateral		
 Reducer	<b>200.0</b> 2.5	<b>272.0</b> 2.5
 Cap	<b>110.0</b> 4.3	<b>145.0</b> 4.3

**Note: Boldface black type** is weight in pounds and **light grey type** underneath is weight factor for insulation.

- Insulation thicknesses and weights are based on average conditions and do not constitute a recommendation for specific thicknesses of materials.
- Insulation weights are based on 85% magnesia and hydrous calcium silicate at 11 lbs/cu. foot. The listed thicknesses and weights of combination covering are the sums of the inner layer of diatomaceous earth at 21 lbs/cu. foot and the outer layer at 11 lbs/cubic foot.
- Insulation weights include allowances for wire, cement, canvas, bands and paint but not special surface finishes.
- To find the weight of covering on flanges, valves or fittings, multiply the weight factor by the weight per foot of covering used on straight pipe.
- Valve weights are approximate. Whenever possible, obtain weights from the manufacturer.
- Cast iron valve weights are for flanged end valves; steel weights for welding end valves.
- All flanged fitting, flanged valve and flange weights include the proportional weight of bolts or studs to make up all joints.

## Cast Iron & Steel Fittings – Line 1: Weight in Pounds, Line 2: Insulation Weight Factor

	Pressure Rating (PSI)									
	Cast Iron					Steel				
	125	250	150	300	400	600	900	1500	2500	
 Screwed or Slip On			<b>292</b> 1.5	<b>699</b> 1.5	<b>650</b> 1.5	<b>950</b> 1.5	<b>1525</b> 1.5			
 Welding Neck			<b>342</b> 1.5	<b>799</b> 1.5	<b>750</b> 1.5	<b>1025</b> 1.5	<b>1575</b> 1.5			
 Lap Joint										
 Blind			<b>567</b> 1.5	<b>1179</b> 1.5	<b>1125</b> 1.5	<b>1525</b> 1.5	<b>2200</b> 1.5			
 S.R. 90° Elbow										
 L.R. 90° Elbow										
 45° Elbow										
 Tee										
 Flanged Bonnet Gate										
 Flanged Bonnet – Globe or Angle										
 Flanged Bonnet – Check										
 Pressure Seal – Bonnet, Gate										
 Pressure Seal – Bonnet, Globe										

## Pipe Insulation








Temp. Range -->	100 – 199	200 – 299	300 – 399	400 – 499	500 – 599	600 – 699	700 – 799	800 – 899	900 – 999	1,000 – 1,099	1,100 – 1,200
85% Magnesia Calcium Silicate	Nom. Thick., In. 1½ 10.4	Nom. Thick., In. 1½ 10.4	Nom. Thick., In. 2 14.1	Nom. Thick., In. 2½ 18.0	Nom. Thick., In. 3 21.9	Nom. Thick., In. 3½ 26.0	Nom. Thick., In. 4 30.2	Nom. Thick., In. 4½ 34.6	Nom. Thick., In. 5 39.1	Nom. Thick., In. 5 39.1	Nom. Thick., In. 6 48.4
Combination						Nom. Thick., In. 3½ 37.0	Nom. Thick., In. 4½ 51.9	Nom. Thick., In. 5½ 67.8	Nom. Thick., In. 6.0 76.0	Nom. Thick., In. 6½ 84.5	Nom. Thick., In. 7 93.2

# Weight of Piping Materials – 28" PIPE (28" O.D.)

## Pipe

Sch./Wall Designation -->	10	Std.	20/XS	30					
Thickness -- In.	0.250	0.312	0.375	0.500	0.625	0.750	0.875	1.000	1.125
Pipe -- Lbs/Ft.	74.0	92.4	110.6	146.9	182.7	218.0	253.0	288.0	323.0
Water -- Lbs/Ft	257.3	255.0	252.7	248.1	243.6	238.9	234.4	230.0	225.6














## Welded Fittings – Line 1: Weight in Pounds, Line 2: Insulation Weight Factor

 L.R. 90° Elbow	<b>626.0</b>	<b>829.0</b>	9.0	9.0
 S.R. 90° Elbow	<b>415.0</b>	<b>551.0</b>	5.4	5.4
 L.R. 45° Elbow	<b>312.0</b>	<b>413.0</b>	3.6	3.6
 Tee	<b>729.0</b>	<b>910.0</b>	7.0	7.0
 Lateral				
 Reducer	<b>210.0</b>	<b>290.0</b>	2.7	2.7
 Cap	<b>120.0</b>	<b>160.0</b>	4.5	4.5

**Note: Boldface black type** is weight in pounds and **light grey type** underneath is weight factor for insulation.

- Insulation thicknesses and weights are based on average conditions and do not constitute a recommendation for specific thicknesses of materials.
- Insulation weights are based on 85% magnesia and hydrous calcium silicate at 11 lbs/cu. foot. The listed thicknesses and weights of combination covering are the sums of the inner layer of diatomaceous earth at 21 lbs/cu. foot and the outer layer at 11 lbs/cubic foot.
- Insulation weights include allowances for wire, cement, canvas, bands and paint but not special surface finishes.
- To find the weight of covering on flanges, valves or fittings, multiply the weight factor by the weight per foot of covering used on straight pipe.
- Valve weights are approximate. Whenever possible, obtain weights from the manufacturer.
- Cast iron valve weights are for flanged end valves; steel weights for welding end valves.
- All flanged fitting, flanged valve and flange weights include the proportional weight of bolts or studs to make up all joints.

## Cast Iron & Steel Fittings – Line 1: Weight in Pounds, Line 2: Insulation Weight Factor

	Pressure Rating (PSI)									
	Cast Iron					Steel				
	125	250	150	300	400	600	900	1500	2500	
 Screwed or Slip On			<b>334</b>	<b>853</b>	<b>780</b>	<b>1075</b>	<b>1800</b>			
			1.5	1.5	1.5	1.5	1.5			
 Welding Neck			<b>364</b>	<b>943</b>	<b>880</b>	<b>1175</b>	<b>1850</b>			
			1.5	1.5	1.5	1.5	1.5			
 Lap Joint										
 Blind			<b>669</b>	<b>1408</b>	<b>1425</b>	<b>1750</b>	<b>2575</b>			
			1.5	1.5	1.5	1.5	1.5			
 S.R. 90° Elbow										
 L.R. 90° Elbow										
 45° Elbow										
 Tee										
 Flanged Bonnet Gate										
 Flanged Bonnet - Globe or Angle										
 Flanged Bonnet - Check										
 Pressure Seal - Bonnet, Gate										
 Pressure Seal - Bonnet, Globe										

## Pipe Insulation








Temp. Range -->	100 – 199	200 – 299	300 – 399	400 – 499	500 – 599	600 – 699	700 – 799	800 – 899	900 – 999	1,000 – 1,099	1,100 – 1,200
85% Magnesia Calcium Silicate	Nom. Thick., In. 1 1/2 11.2	1 1/2 11.2	2 15.1	2 1/2 19.2	3 23.4	3 1/2 27.8	4 32.3	4 1/2 36.9	5 41.6	5 41.6	6 51.4
Combination						3 1/2 39.5	4 1/2 55.4	5 1/2 72.2	6 80.9	6 1/2 89.8	7 99.0

# Weight of Piping Materials – 30" PIPE (30" O.D.)

## Pipe

Sch./Wall Designation -->	5S	10 & 10S	Std.	20/XS	30				
Thickness -- In.	0.250	0.312	0.375	0.500	0.625	0.75	0.875	1.000	1.125
Pipe -- Lbs/Ft.	79.0	98.9	118.7	1576.0	196.1	234.0	272.0	310.0	347.0
Water -- Lbs/Ft	296.3	293.5	2910	286.0	281.1	276.6	271.8	267	262.2

## Welded Fittings – Line 1: Weight in Pounds, Line 2: Insulation Weight Factor

 L.R. 90° Elbow	<b>478.0</b> 10.0	<b>775.0</b> 10.0	<b>953.0</b> 10.0	<b>596.0</b> 10.0
 S.R. 90° Elbow	<b>319.0</b> 5.9	<b>470.0</b> 5.9	<b>644.0</b> 5.9	<b>388.0</b> 5.9
 L.R. 45° Elbow	<b>239.0</b> 3.9	<b>358.0</b> 3.9	<b>475.0</b> 3.9	<b>298.0</b> 3.9
 Tee		<b>855.0</b> 7.8	<b>1065.0</b> 7.8	
 Lateral				
 Reducer		<b>220.0</b> 3.9	<b>315.0</b> 3.9	
 Cap		<b>125.0</b> 4.8	<b>175.0</b> 4.8	














**Note: Boldface black type** is weight in pounds and light grey type underneath is weight factor for insulation.

- Insulation thicknesses and weights are based on average conditions and do not constitute a recommendation for specific thicknesses of materials.
- Insulation weights are based on 85% magnesia and hydrous calcium silicate at 11 lbs/cu. foot. The listed thicknesses and weights of combination covering are the sums of the inner layer of diatomaceous earth at 21 lbs/cu. foot and the outer layer at 11 lbs/cubic foot.
- Insulation weights include allowances for wire, cement, canvas, bands and paint but not special surface finishes.
- To find the weight of covering on flanges, valves or fittings, multiply the weight factor by the weight per foot of covering used on straight pipe.
- Valve weights are approximate. Whenever possible, obtain weights from the manufacturer.
- Cast iron valve weights are for flanged end valves; steel weights for welding end valves.
- All flanged fitting, flanged valve and flange weights include the proportional weight of bolts or studs to make up all joints.

## Pipe Insulation

Temp. Range -->	100 – 199	200 – 299	300 – 399	400 – 499	500 – 599	600 – 699	700 – 799	800 – 899	900 – 999	1,000 – 1,099	1,100 – 1,200
85% Magnesia Calcium Silicate	Nom. Thick., In. Lbs/Ft 1½ 11.9	1½ 11.9	2 16.1	2½ 20.5	3 25.0	3½ 29.5	4 34.3	4½ 39.1	5 44.1	5 44.1	6 54.4
Combination	Nom. Thick., In. Lbs/Ft					3½ 42.1	4½ 58.9	5½ 76.5	6 85.7	6½ 95.1	7 104.7

## Cast Iron & Steel Fittings – Line 1: Weight in Pounds, Line 2: Insulation Weight Factor








	Pressure Rating (PSI)									
	Cast Iron		Steel							
	125	250	150	300	400	600	900	1500	2500	
 Screwed or Slip On			<b>365</b> 1.5	<b>975</b> 1.5	<b>900</b> 1.5	<b>1175</b> 1.5	<b>2075</b> 1.5			
 Welding Neck			<b>410</b> 1.5	<b>1095</b> 1.5	<b>1000</b> 1.5	<b>1300</b> 1.5	<b>2150</b> 1.5			
 Lap Joint										
 Blind			<b>770</b> 1.5	<b>1665</b> 1.5	<b>1675</b> 1.5	<b>2000</b> 1.5	<b>3025</b> 1.5			
 S.R. 90° Elbow										
 L.R. 90° Elbow										
 45° Elbow										
 Tee										
 Flanged Bonnet Gate										
 Flanged Bonnet - Globe or Angle										
 Flanged Bonnet - Check										
 Pressure Seal - Bonnet, Gate										
 Pressure Seal - Bonnet, Globe										

# Weight of Piping Materials – 32" PIPE (32" O.D.)

## Pipe

Sch./Wall Designation -->	10	Std.	20/XS	30	40					
Thickness -- In.	0.250	0.312	0.375	0.500	0.625	0.688	0.750	0.875	1.000	1.125
Pipe -- Lbs/Ft.	85.0	105.8	126.7	168.2	209.4	229.9	250.0	291.0	331.0	371.0
Water -- Lbs/Ft.	337.8	335.0	323.3	327.0	321.8	319.2	316.7	311.6	306.4	301.3














## Welded Fittings – Line 1: Weight in Pounds, Line 2: Insulation Weight Factor

 L.R. 90° Elbow	<b>818.0</b> 10.5	<b>1090.0</b> 10.5
 S.R. 90° Elbow	<b>546.0</b> 6.3	<b>722.0</b> 6.3
 L.R. 45° Elbow	<b>408.0</b> 4.2	<b>541.0</b> 4.2
 Tee	<b>991.0</b> 8.4	<b>1230.0</b> 8.4
 Lateral		
 Reducer	<b>255.0</b> 3.1	<b>335.0</b> 3.1
 Cap	<b>145.0</b> 5.2	<b>190.0</b> 5.2

**Note: Boldface black type** is weight in pounds and **light grey type** underneath is weight factor for insulation.

- Insulation thicknesses and weights are based on average conditions and do not constitute a recommendation for specific thicknesses of materials.
- Insulation weights are based on 85% magnesia and hydrous calcium silicate at 11 lbs/cu. foot. The listed thicknesses and weights of combination covering are the sums of the inner layer of diatomaceous earth at 21 lbs/cu. foot and the outer layer at 11 lbs/cubic foot.
- Insulation weights include allowances for wire, cement, canvas, bands and paint but not special surface finishes.
- To find the weight of covering on flanges, valves or fittings, multiply the weight factor by the weight per foot of covering used on straight pipe.
- Valve weights are approximate. Whenever possible, obtain weights from the manufacturer.
- Cast iron valve weights are for flanged end valves; steel weights for welding end valves.
- All flanged fitting, flanged valve and flange weights include the proportional weight of bolts or studs to make up all joints.

## Cast Iron & Steel Fittings – Line 1: Weight in Pounds, Line 2: Insulation Weight Factor

	Pressure Rating (PSI)								
	Cast Iron		Steel						
	125	250	150	300	400	600	900	1500	2500
 Screwed or Slip On			<b>476</b> 1.5	<b>1093</b> 1.5	<b>1025</b> 1.5	<b>1375</b> 1.5	<b>2500</b> 1.5		
 Welding Neck			<b>516</b> 1.5	<b>1228</b> 1.5	<b>1150</b> 1.5	<b>1500</b> 1.5	<b>2575</b> 1.5		
 Lap Joint									
 Blind			<b>951</b> 1.5	<b>1978</b> 1.5	<b>1975</b> 1.5	<b>2300</b> 1.5	<b>3650</b> 1.5		
 S.R. 90° Elbow									
 L.R. 90° Elbow									
 45° Elbow									
 Tee									
 Flanged Bonnet Gate									
 Flanged Bonnet - Globe or Angle									
 Flanged Bonnet - Check									
 Pressure Seal - Bonnet, Gate									
 Pressure Seal - Bonnet, Globe									

## Pipe Insulation








Temp. Range -->	100 - 199	200 - 299	300 - 399	400 - 499	500 - 599	600 - 699	700 - 799	800 - 899	900 - 999	1,000 - 1,099	1,100 - 1,200
85% Magnesia Calcium Silicate	Nom. Thick., In. Lbs/Ft 1½ 12.7	1½ 12.7	2 17.1	2½ 21.7	3 26.5	3½ 31.3	4 36.3	4½ 41.4	5 46.6	5 46.6	6 57.5
Combination						3½ 44.7	4½ 62.3	5½ 80.9	6 90.5	6½ 100.4	7 110.5

# Weight of Piping Materials – 34" PIPE (34" O.D.)

## Pipe

Sch./Wall Designation -->	10	Std.	20/XS	30	40						
Thickness -- In.	0.250	0.312	0.375	0.500	0.625	0.688	0.750	0.875	1.000	1.125	
Pipe -- Lbs/Ft.	90.0	112.4	134.7	178.9	222.8	244.6	266	310.0	353.0	395.0	
Water -- Lbs/Ft	382.0	379.1	376.0	370.3	365.0	362.2	359.5	354.1	348.6	343.2	














## Welded Fittings – Line 1: Weight in Pounds, Line 2: Insulation Weight Factor

 L.R. 90° Elbow	<b>926.0</b> 11.0	<b>1230.0</b> 11.0
 S.R. 90° Elbow	<b>617.0</b> 5.5	<b>817.0</b> 5.5
 L.R. 45° Elbow	<b>463.0</b> 4.4	<b>615.0</b> 4.4
 Tee	<b>1136.0</b> 8.9	<b>1420.0</b> 8.9
 Lateral		
 Reducer	<b>270.0</b> 3.3	<b>355.0</b> 3.3
 Cap	<b>160.0</b> 5.6	<b>210.0</b> 5.6

**Note: Boldface black type** is weight in pounds and **light grey type** underneath is weight factor for insulation.

- Insulation thicknesses and weights are based on average conditions and do not constitute a recommendation for specific thicknesses of materials.
- Insulation weights are based on 85% magnesia and hydrous calcium silicate at 11 lbs/cu. foot. The listed thicknesses and weights of combination covering are the sums of the inner layer of diatomaceous earth at 21 lbs/cu. foot and the outer layer at 11 lbs/cubic foot.
- Insulation weights include allowances for wire, cement, canvas, bands and paint but not special surface finishes.
- To find the weight of covering on flanges, valves or fittings, multiply the weight factor by the weight per foot of covering used on straight pipe.
- Valve weights are approximate. Whenever possible, obtain weights from the manufacturer.
- Cast iron valve weights are for flanged end valves; steel weights for welding end valves.
- All flanged fitting, flanged valve and flange weights include the proportional weight of bolts or studs to make up all joints.

## Cast Iron & Steel Fittings – Line 1: Weight in Pounds, Line 2: Insulation Weight Factor

	Pressure Rating (PSI)								
	Cast Iron				Steel				
	125	250	150	300	400	600	900	1500	2500
 Screwed or Slip On			<b>515</b> 1.5	<b>1281</b> 1.5	<b>1150</b> 1.5	<b>1500</b> 1.5	<b>2950</b> 1.5		
 Welding Neck			<b>560</b> 1.5	<b>1406</b> 1.5	<b>1300</b> 1.5	<b>1650</b> 1.5	<b>3025</b> 1.5		
 Lap Joint									
 Blind			<b>1085</b> 1.5	<b>2231</b> 1.5	<b>2250</b> 1.5	<b>2575</b> 1.5	<b>4275</b> 1.5		
 S.R. 90° Elbow									
 L.R. 90° Elbow									
 45° Elbow									
 Tee									
 Flanged Bonnet Gate									
 Flanged Bonnet – Globe or Angle									
 Flanged Bonnet – Check									
 Pressure Seal – Bonnet, Gate									
 Pressure Seal – Bonnet, Globe									

## Pipe Insulation








Temp. Range -->	100 – 199	200 – 299	300 – 399	400 – 499	500 – 599	600 – 699	700 – 799	800 – 899	900 – 999	1,000 – 1,099	1,100 – 1,200
85% Magnesia Calcium Silicate	Nom. Thick., In. Lbs/Ft 1½ 13.4	1½ 13.4	2 18.2	2½ 23.0	3 28.0	3½ 33.1	4 38.3	4½ 43.7	5 49.1	5 49.1	6 60.5
Combination						3½ 47.2	4½ 65.8	5½ 85.3	6 95.4	6½ 105.7	7 116.3

# Weight of Piping Materials – 36" PIPE (36" O.D.)

## Pipe

Sch./Wall Designation -->	10	Std.	20/XS	30	40				
Thickness -- In.	0.250	0.312	0.375	0.500	0.625	0.750	0.875	1.000	1.125
Pipe -- Lbs/Ft.	96.0	119.1	142.7	189.6	236.1	282.4	328.0	374.0	419.0
Water -- Lbs/Ft	429.1	425.9	422.6	416.6	411.0	405.1	399.4	393.6	387.9














## Welded Fittings – Line 1: Weight in Pounds, Line 2: Insulation Weight Factor

 L.R. 90° Elbow	<b>1040.0</b> 12.0	<b>1380.0</b> 12.0
 S.R. 90° Elbow	<b>692.0</b> 5.0	<b>913.0</b> 5.0
 L.R. 45° Elbow	<b>518.0</b> 4.8	<b>686.0</b> 4.8
 Tee	<b>1294.0</b> 9.5	<b>1610.0</b> 9.5
 Lateral		
 Reducer	<b>340.0</b> 3.6	<b>360.0</b> 3.6
 Cap	<b>175.0</b> 6.0	<b>235.0</b> 6.0

**Note: Boldface black type** is weight in pounds and **light grey type** underneath is weight factor for insulation.

- Insulation thicknesses and weights are based on average conditions and do not constitute a recommendation for specific thicknesses of materials.
- Insulation weights are based on 85% magnesia and hydrous calcium silicate at 11 lbs/cu. foot. The listed thicknesses and weights of combination covering are the sums of the inner layer of diatomaceous earth at 21 lbs/cu. foot and the outer layer at 11 lbs/cubic foot.
- Insulation weights include allowances for wire, cement, canvas, bands and paint but not special surface finishes.
- To find the weight of covering on flanges, valves or fittings, multiply the weight factor by the weight per foot of covering used on straight pipe.
- Valve weights are approximate. Whenever possible, obtain weights from the manufacturer.
- Cast iron valve weights are for flanged end valves; steel weights for welding end valves.
- All flanged fitting, flanged valve and flange weights include the proportional weight of bolts or studs to make up all joints.

## Cast Iron & Steel Fittings – Line 1: Weight in Pounds, Line 2: Insulation Weight Factor

	Pressure Rating (PSI)									
	Cast Iron		Steel							
	125	250	150	300	400	600	900	1500	2500	
 Screwed or Slip On			<b>588</b> 1.5	<b>1485</b> 1.5	<b>1325</b> 1.5	<b>1600</b> 1.5	<b>3350</b> 1.5			
 Welding Neck			<b>628</b> 1.5	<b>1585</b> 1.5	<b>1475</b> 1.5	<b>1750</b> 1.5	<b>3450</b> 1.5			
 Lap Joint										
 Blind			<b>1233</b> 1.5	<b>2560</b> 1.5	<b>2525</b> 1.5	<b>2950</b> 1.5	<b>4900</b> 1.5			
 S.R. 90° Elbow										
 L.R. 90° Elbow										
 45° Elbow										
 Tee										
 Flanged Bonnet Gate										
 Flanged Bonnet - Globe or Angle										
 Flanged Bonnet - Check										
 Pressure Seal - Bonnet, Gate										
 Pressure Seal - Bonnet, Globe										

## Pipe Insulation








Temp. Range -->	100 - 199	200 - 299	300 - 399	400 - 499	500 - 599	600 - 699	700 - 799	800 - 899	900 - 999	1,000 - 1,099	1,100 - 1,200
85% Magnesia Calcium Silicate	Nom. Thick., In. Lbs/Ft 1½ 14.2	1½ 14.2	2 19.2	2½ 24.2	3 29.5	3½ 34.8	4 40.3	4½ 45.9	5 51.7	5 51.7	6 63.5
Combination						3½ 49.8	4½ 69.3	5½ 89.7	6 100.2	6½ 111.0	7 122.0

# Weight of Piping Materials – 42" PIPE (42" O.D.)

## Pipe

Sch./Wall Designation -->	Std.	20/XS	30	40				
Thickness -- In.	0.250	0.375	0.500	0.625	0.75	1000	1.250	1.500
Pipe -- Lbs/Ft.	112.0	166.7	221.6	276.0	330.0	438.0	544.0	649.0
Water -- Lbs/Ft	586.4	578.7	571.7	565.4	558.4	544.8	531.2	517.9














## Welded Fittings – Line 1: Weight in Pounds, Line 2: Insulation Weight Factor

 L.R. 90° Elbow	<b>1420.0</b> 15.0	<b>1880.0</b> 15.0
 S.R. 90° Elbow	<b>1079</b> 9.0	<b>1430.0</b> 9.0
 L.R. 45° Elbow	<b>707.0</b> 6.0	<b>937.0</b> 6.0
 Tee	<b>1870.0</b>	<b>2415.0</b>
 Lateral		
 Reducer	<b>310.0</b> 4.5	<b>410.0</b> 4.5
 Cap	<b>230.0</b> 7.5	<b>300.0</b> 7.5

**Note: Boldface black type** is weight in pounds and **light grey type** underneath is weight factor for insulation.

- Insulation thicknesses and weights are based on average conditions and do not constitute a recommendation for specific thicknesses of materials.
- Insulation weights are based on 85% magnesia and hydrous calcium silicate at 11 lbs/cu. foot. The listed thicknesses and weights of combination covering are the sums of the inner layer of diatomaceous earth at 21 lbs/cu. foot and the outer layer at 11 lbs/cubic foot.
- Insulation weights include allowances for wire, cement, canvas, bands and paint but not special surface finishes.
- To find the weight of covering on flanges, valves or fittings, multiply the weight factor by the weight per foot of covering used on straight pipe.
- Valve weights are approximate. Whenever possible, obtain weights from the manufacturer.
- Cast iron valve weights are for flanged end valves; steel weights for welding end valves.
- All flanged fitting, flanged valve and flange weights include the proportional weight of bolts or studs to make up all joints.

## Cast Iron & Steel Fittings – Line 1: Weight in Pounds, Line 2: Insulation Weight Factor

	Pressure Rating (PSI)							
	Cast Iron		Steel					
	125	250	150	300	400	600	900	1500 2500
 Screwed or Slip On			<b>792</b> 1.5	<b>1895</b> 1.5	<b>1759</b> 1.5	<b>2320</b> 1.5		
 Welding Neck			<b>862</b> 1.5	<b>2024</b> 1.5	<b>1879</b> 1.5	<b>2414</b> 1.5		
 Lap Joint								
 Blind			<b>1733</b> 1.5	<b>3449</b> 1.5	<b>3576</b> 1.5	<b>4419</b> 1.5		
 S.R. 90° Elbow								
 L.R. 90° Elbow								
 45° Elbow								
 Tee								
 Flanged Bonnet Gate								
 Flanged Bonnet - Globe or Angle								
 Flanged Bonnet - Check								
 Pressure Seal - Bonnet, Gate								
 Pressure Seal - Bonnet, Globe								

## Pipe Insulation

Temp. Range -->	100 – 199	200 – 299	300 – 399	400 – 499	500 – 599	600 – 699	700 – 799	800 – 899	900 – 999	1,000 – 1,099	1,100 – 1,200
85% Magnesia Calcium Silicate	Nom. Thick., In. Lbs/Ft 1½ 16.5	1½ 16.5	2 22.2	2½ 28.0	3 34.0	3½ 40.1	4 46.4	4½ 52.7	5 59.2	5 59.2	6 72.6
Combination						3½ 57.4	4½ 79.7	5½ 102.8	6 114.8	6½ 126.9	7 139.3

# Thermal Expansion of Pipe Materials

## Thermal Expansion of Pipe Materials – Inches Per Foot

Carbon Steel • Carbon Moly Steel • Low-Chrome Steel (Thru 3% Cr) – Temperature										
Temp °F	0	10	20	30	40	50	60	70	80	90
-200	-0.0180	-0.0187	-0.0192	-0.0198	-0.0203	-0.0209	-0.0215	-0.0220	-0.0225	-0.0230
-100	-0.0121	-0.0127	-0.0133	-0.014	-0.0146	-0.0152	-0.0158	-0.0163	-0.0169	-0.0171
0	-0.0051	-0.0058	-0.0065	-0.0073	-0.0080	-0.0087	-0.0096	-0.0103	-0.0109	-0.0116
0	-0.0051	-0.0044	-0.0037	-0.0029	-0.0022	-0.0015	-0.0007	0.0000	0.0008	0.0015
100	0.0023	0.0030	0.0038	0.0046	0.0053	0.0061	0.0068	0.0076	0.0084	0.0091
200	0.0099	0.0107	0.0116	0.0124	0.0132	0.0141	0.0149	0.0157	0.0165	0.0174
300	0.0182	0.0191	0.0200	0.0208	0.0217	0.0226	0.0235	0.0244	0.0252	0.0261
400	0.027	0.0279	0.0288	0.0298	0.0307	0.0316	0.0325	0.0344	0.0344	0.0353
500	0.0362	0.0372	0.0382	0.0391	0.0401	0.0411	0.0421	0.0431	0.0440	0.0450
600	0.0460	0.047	0.0481	0.0491	0.0501	0.0512	0.0522	0.0532	0.0542	0.0553
700	0.0563	0.0574	0.0584	0.0595	0.0606	0.0617	0.0627	0.0638	0.0649	0.0659
800	0.0670	0.0681	0.0692	0.0703	0.0714	0.0726	0.0737	0.0748	0.0759	0.0770
900	0.0781	0.0792	0.0803	0.0813	0.0824	0.0835	0.0846	0.0857	0.0867	0.0878
1,000	0.0889	0.0901	0.0912	0.0924	0.9359	0.0946	0.0958	0.097	0.0981	0.3993
1,100	0.1004	0.1015	0.1025	0.1036	0.1046	0.1057	0.1068	0.1078	0.1089	0.1099
1,200	0.1110	0.1121	0.1132	0.1144	0.1155	0.1166	0.1177	0.1188	0.1200	0.1211
1,300	0.1222	0.1233	0.1244	0.1256	0.1267	0.1278	0.1299	0.1320	0.1342	0.1363
1,400	0.1334	0.0000	0.0000	0.0000	0.0000	0.0000	0.0000	0.0000	0.0000	0.0000

## Thermal Expansion of Pipe Materials – Inches Per Foot

Austenitic Stainless Steels (304,316, 347) – Temperature										
Temp °F	0	10	20	30	40	50	60	70	80	90
-200	-0.0281	-0.0295	-0.0305	-0.0314	-0.0324	-0.0334	-0.0343	-0.0353	-0.0362	-0.0372
-100	-0.0187	-0.0197	-0.0207	-0.0216	-0.0226	-0.0236	-0.0245	-0.0254	-0.0263	-0.0272
0	-0.0078	-0.0089	-0.0001	-0.0112	-0.0123	-0.0134	-0.0145	-0.0155	-0.0166	-0.0176
0	-0.0078	-0.0067	-0.0056	-0.0044	-0.0033	-0.0022	-0.0011	0.0000	0.0012	0.0023
100	0.0034	0.0045	0.0056	0.0068	0.0079	0.009	0.0101	0.0112	0.0124	0.0135
200	0.0146	0.0158	0.0169	0.0181	0.0192	0.0203	0.0215	0.0227	0.0238	0.0250
300	0.0261	0.0273	0.0285	0.0297	0.0309	0.0321	0.0332	0.0344	0.0356	0.0368
400	0.0380	0.0392	0.0404	0.0416	0.0428	0.044	0.0453	0.0465	0.0477	0.0489
500	0.0501	0.0513	0.0526	0.0538	0.0550	0.0562	0.0575	0.0587	0.0599	0.0612
600	0.0624	0.0637	0.0649	0.0662	0.0674	0.0687	0.0700	0.0712	0.0725	0.0737
700	0.0750	0.0763	0.0776	0.0789	0.0802	0.0815	0.0828	0.0841	0.0854	0.0867
800	0.0880	0.0893	0.0906	0.092	0.0933	0.0946	0.0959	0.0972	0.0986	0.0999
900	0.1012	0.1026	0.1039	0.1053	0.1066	0.108	0.1094	0.1107	0.1121	0.1134
1,000	0.1148	0.1162	0.1175	0.1189	0.1202	0.1216	0.1229	0.1243	0.1257	0.1270
1,100	0.1284	0.1298	0.1311	0.1325	0.1338	0.1352	0.1366	0.1379	0.1393	0.1406
1,200	0.1420	0.1434	0.1447	0.1461	0.1474	0.1488	0.1502	0.1515	0.1529	0.1542
1,300	0.1556	0.1570	0.1583	0.1597	0.1610	0.1624	0.1638	0.1651	0.1665	0.1678
1,400	0.1692	0.1704	0.1717	0.1731	0.1744	0.1757	0.1771	0.1784	0.1796	0.1811

# Thermal Expansion of Pipe Materials

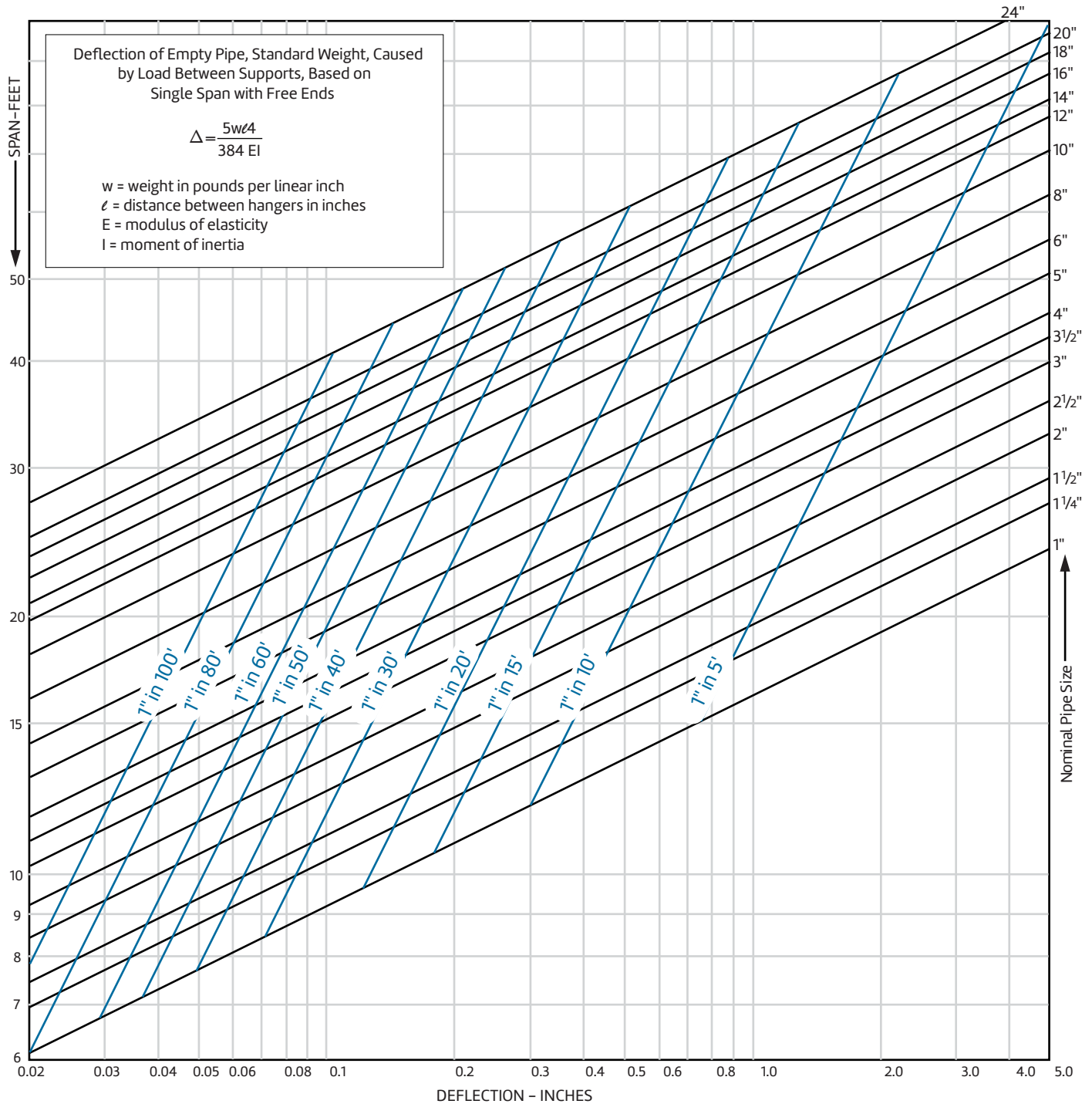
Thermal Expansion of Pipe Materials – Inches Per Foot

Temp °F	Intermediate Alloy Steels (5% thru 9% Cr MO)	Copper	Brass	Aluminum
-200	-	-0.0275	-0.2870	-0.0373
-150	-	-0.0231	-0.0241	-0.0310
-100	-	-0.1830	-0 1900	-0.0244
-50	-	-0.1320	-0.0137	-0.0176
0	-	-0.0790	-0.0081	-0.0104
50	-	-0.0022	-0.0023	-0.0030
70	0.0000	0.0000	0.0000	0.0000
100	0.0022	0.0034	0.0035	0.0046
150	0.0058	0.0091	0.0093	0.0123
200	0.0094	0.0151	0.0152	0.0200
250	0.0132	0.0208	0.0214	0.0283
300	0.0171	0.0267	0.0276	0.0366
350	0.0210	0.0327	0.034	0.0452
400	0.0250	0.0388	0.0405	0.0539
450	0.0292	0.0449	0.0472	0.0628
500	0.0335	0.0512	0.0540	0.0717
550	0.0379	0.0574	0.0610	0.081
600	0.0424	0.0639	0.068	0.0903
650	0.0469	0.0703	0.0753	-
700	0.0514	0.0768	0.0826	-
750	0.0562	0.0834	0.0902	-
800	0.0610	0.09	0.0978	-
850	0.0658	0.0967	0 1056	-
900	0.0707	0.1037	0 1135	-
950	0.0756	0.1105	0 1216	-
1000	0.0806	0.1175	0 1298	-
1050	0.0855	-	-	-
1100	0.0905	-	-	-
1150	0.0952	-	-	-
1200	0.1000	-	-	-
1250	0.1053	-	-	-
1300	0.1106	-	-	-
1350	0.1155	-	-	-
1400	0.1205	-	-	-

Properties of Saturated Steam  
(Standard Barometer 14,696 PSI)

Gauge Pressure Lbs./Sq. Inch	Temp °F
0	212.00
5	227.14
10	239.39
15	249.75
20	258.76
25	266.78
30	274.02
35	280.62
40	286.71
45	292.37
50	297.66
55	302.62
60	307.32
65	311.77
70	316.00
75	320.03
80	323.90
85	327.59
90	331.15
95	334.57
100	337.88
150	365.85
200	387.78
250	406.01
300	421.71
350	435.59
400	448.12
450	459.59
500	469.99
550	479.93
600	488.79
650	497.29
700	505.15
750	512.75
800	520.92
850	526.97
900	533.63
950	540.26
1000	546.12
1050	551.98
1100	557.84

# Deflection of Empty Pipe



Values are plotted for the pipes empty since this more nearly approaches the condition that exists for pocketing of condensation. Although the weight of fluid carried by the pipe will cause an increase in the deflection of the pipe between supports, this increased sag disappears during drainage. Therefore, the deflection produced by the weight of empty pipe should be considered in determining slope for drainage.

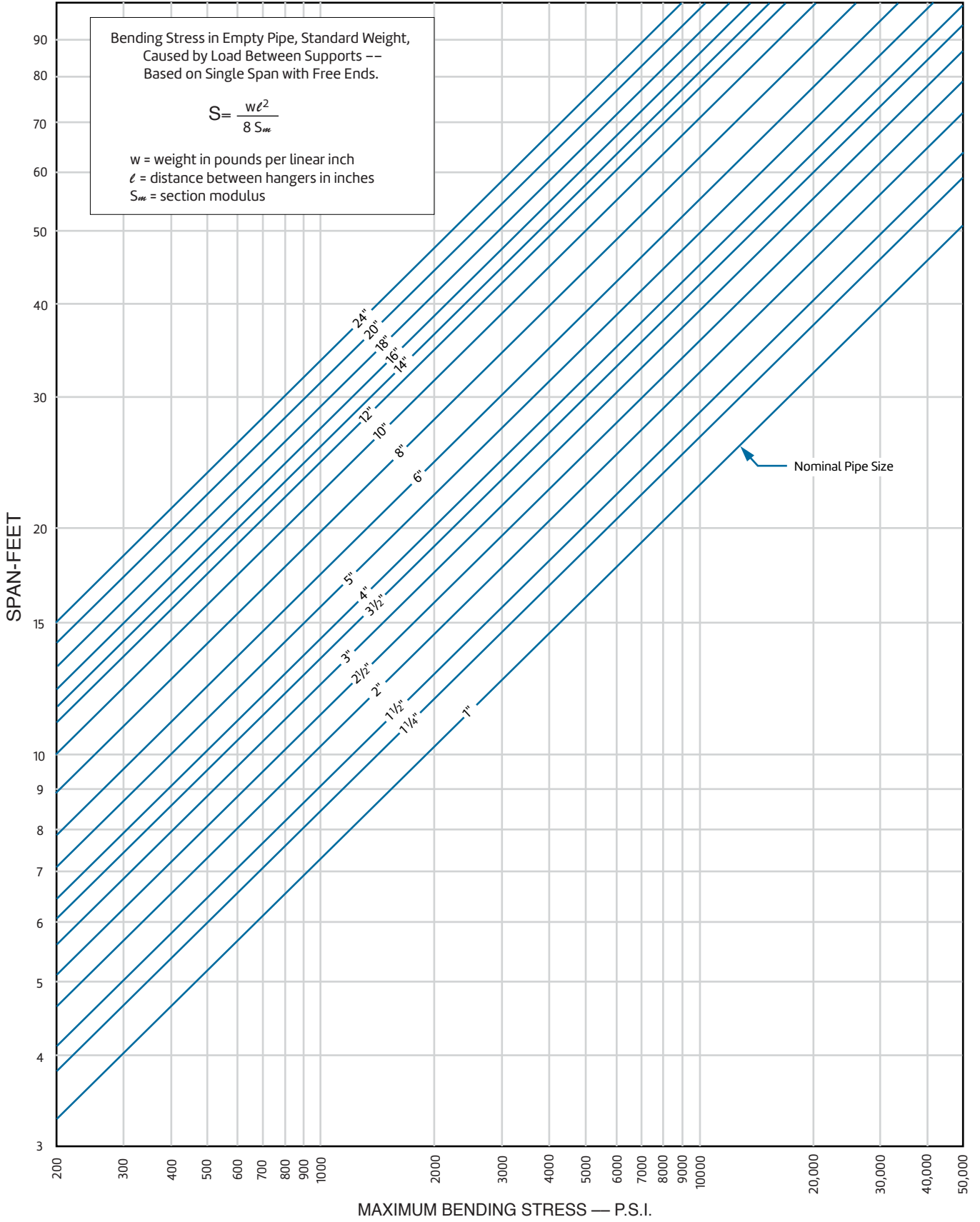
This chart is based on E = 29,000,000 P.S.I.



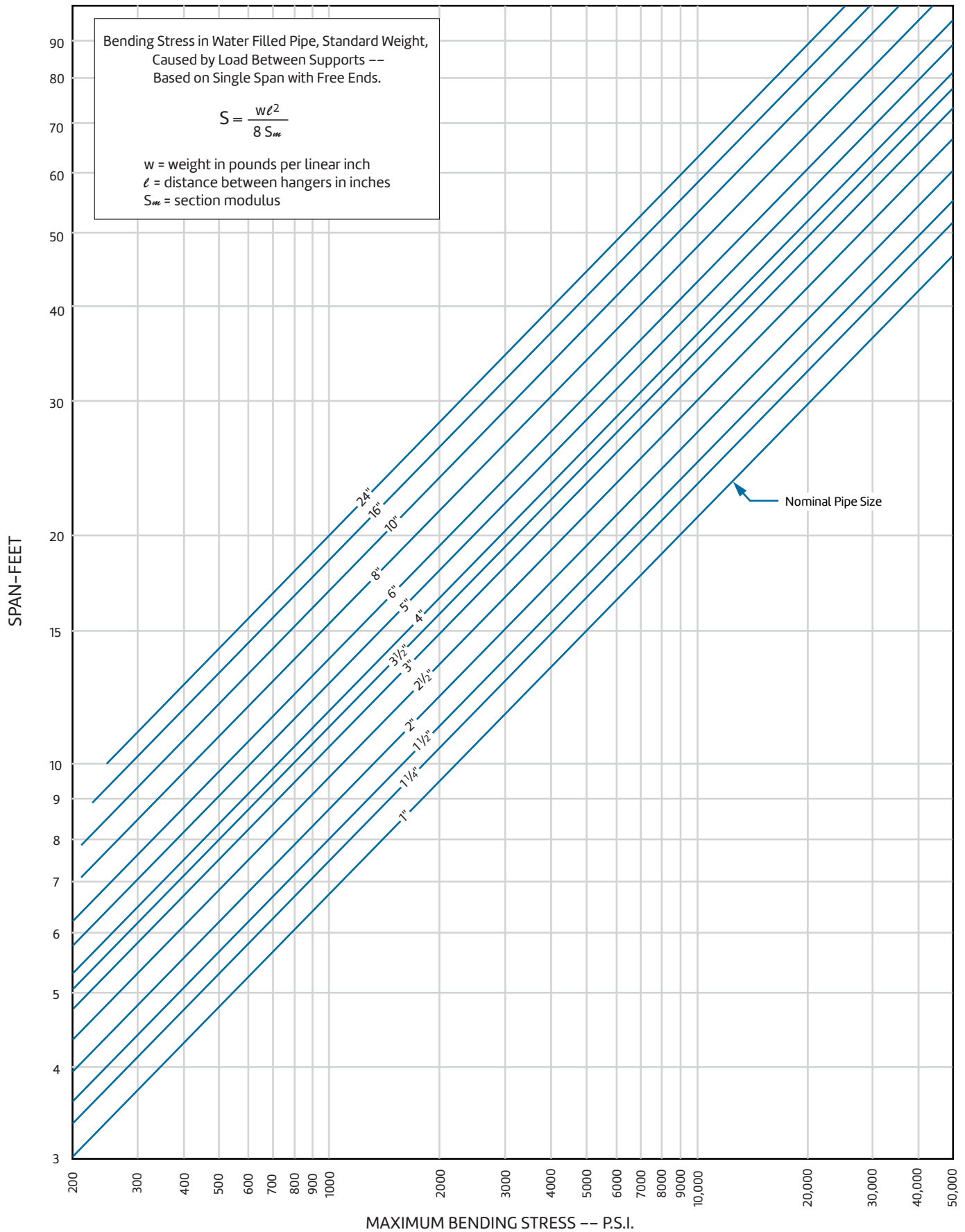
asc-es.com

Building connections that last™

# Bending Stress in Empty Pipe



# Bending Stress in Water Filled Pipe



## Minimum Distance to First Hanger

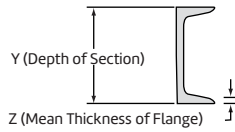
$$L = \sqrt{\frac{\Delta \times (\text{O.D. of Pipe}) \times 10^6}{1.6 \times S}} \quad S = 10,000 \text{ p.s.i}$$

### Pipe Size, Pipe O.D.

	1 1.315	1¼ 1.66	1½ 1.900	2 2.375	2½ 2.875	3 3.5	3½ 4	4 4.5	5 5.563	6 6.625	8 8.625	10 10.75	12 12.75	14 14	16 16	18 18	20 20
¼	4½	5	5½	6	6½	7½	8	8½	9½	10	11½	13	14	15	16	17	17½
½	6½	7	7½	8½	9½	10½	11	12	13	14½	16½	18½	20	21	22½	23½	25
¾	8	9	9½	10½	11½	13	13½	14½	16	17½	20	22½	24½	25½	27½	29	30½
1	9	10	11	12	13½	15	16	17	18½	20½	23	26	28	29½	31½	33½	35½
1¼	10	11½	12	13½	15	16¼	17½	19	21	23	26	29	31½	39	35½	37½	39½
1½	11	12½	13½	15	16½	18	19½	20½	23	25	28½	31½	34½	36	38½	41	43½
1¾	12	13½	14½	16	17½	19½	21	22	24½	27	30½	34½	37½	39	42	44½	47
2	13	14½	15½	17	19	21	22½	23½	26½	29	33	36½	40	42	44½	47½	50
2¼	13½	15½	16½	18½	20	22	23½	25	28	30¼	35	39	42½	44½	47½	50½	53
2½	14½	16	17	19½	21	23½	25	26½	29½	32	36½	41	44½	47	50	53	56
2¾	15	17	18	20	22	24½	26	28	31	33½	38½	43	47	49	52½	55½	58½
3	15½	17½	19	21	23	25½	27½	29	32½	35	40	45	49	51	55	58	61
3½	17	19	20½	23	25	27½	29½	31½	35	38	43½	48½	53	55½	59	62½	66
4	18	20½	22	24½	27	29½	31½	33½	37½	40½	46½	52	56½	59	59	63	70½
4½	19	21½	23	26	28½	31½	33½	35½	39½	43	49½	55	60	62½	67	71	75
5	20½	23	24½	27	30	33	35½	37½	41½	45½	52	58	63	66	70½	75	79
5½	21½	24	25½	28½	31½	34½	37	39½	43½	47½	54½	61	66	69½	74	78½	83
6	22	25	26½	30	33	36	38½	41	45½	50	57	63½	69	72½	77½	82	86½

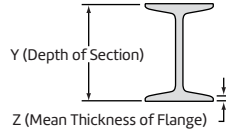
Definition

## American Standard Channels



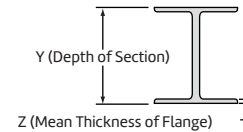
Y in	Wt. / Ft. lb	Width in	Z in
3	4.1	1 <sup>5</sup> / <sub>8</sub>	0.250
	5.0	1 <sup>1</sup> / <sub>2</sub>	
	6.0	1 <sup>5</sup> / <sub>8</sub>	
4	5.4	1 <sup>5</sup> / <sub>8</sub>	0.313
	7.25	1 <sup>3</sup> / <sub>4</sub>	
5	6.7	1 <sup>3</sup> / <sub>4</sub>	0.313
	9.0	1 <sup>7</sup> / <sub>8</sub>	
6	8.2	1 <sup>7</sup> / <sub>8</sub>	0.375
	10.5	2	
7	13.0	2 <sup>1</sup> / <sub>8</sub>	0.375
	9.8	2 <sup>1</sup> / <sub>8</sub>	
8	12.15	2 <sup>1</sup> / <sub>4</sub>	0.375
	14.75	2 <sup>3</sup> / <sub>8</sub>	
	11.5	2 <sup>1</sup> / <sub>4</sub>	
9	13.75	2 <sup>1</sup> / <sub>4</sub>	0.375
	18.75	2 <sup>1</sup> / <sub>2</sub>	
	13.4	2 <sup>3</sup> / <sub>8</sub>	
10	15.0	2 <sup>1</sup> / <sub>2</sub>	0.438
	20.0	2 <sup>5</sup> / <sub>8</sub>	
	15.3	2 <sup>5</sup> / <sub>8</sub>	
12	20.0	2 <sup>3</sup> / <sub>4</sub>	0.438
	25.0	2 <sup>7</sup> / <sub>8</sub>	
	30.0	3	
15	20.7	3	0.500
	25.0	3	
	30.0	3 <sup>1</sup> / <sub>8</sub>	
18	33.9	3 <sup>3</sup> / <sub>8</sub>	0.625
	40.0	3 <sup>1</sup> / <sub>2</sub>	
	50.0	3 <sup>3</sup> / <sub>4</sub>	
18	42.7	4	0.625
	45.8	4	
	51.9	4 <sup>1</sup> / <sub>4</sub>	
	58.0	4 <sup>1</sup> / <sub>4</sub>	

## S Shapes



Y in	Wt. / Ft. lb	Width in	Z in
3	5.7	2 <sup>3</sup> / <sub>8</sub>	0.250
	7.5	2 <sup>1</sup> / <sub>2</sub>	
4	7.7	2 <sup>5</sup> / <sub>8</sub>	0.313
	9.5	2 <sup>3</sup> / <sub>4</sub>	
5	10.0	3	0.313
	14.75	3 <sup>1</sup> / <sub>4</sub>	
6	12.5	3 <sup>5</sup> / <sub>8</sub>	0.375
	12.25	3 <sup>5</sup> / <sub>8</sub>	
7	15.3	3 <sup>5</sup> / <sub>8</sub>	0.375
	20.0	3 <sup>7</sup> / <sub>8</sub>	
8	18.4	4	0.438
	23.0	4 <sup>1</sup> / <sub>8</sub>	
10	25.4	4 <sup>5</sup> / <sub>8</sub>	0.500
	35.0	5	
12	31.8	5	0.563
	35.0	5 <sup>1</sup> / <sub>8</sub>	
	40.8	5 <sup>1</sup> / <sub>4</sub>	
15	39.0	5 <sup>1</sup> / <sub>2</sub>	0.688
	50.0	5 <sup>1</sup> / <sub>2</sub>	
	50.0	5 <sup>5</sup> / <sub>8</sub>	
18	42.9	5 <sup>1</sup> / <sub>2</sub>	0.625
	50.0	5 <sup>5</sup> / <sub>8</sub>	
20	54.7	6 <sup>1</sup> / <sub>4</sub>	0.688
	70.0	6 <sup>1</sup> / <sub>4</sub>	
20.3	66.0	6 <sup>1</sup> / <sub>4</sub>	0.813
	96.0	6 <sup>3</sup> / <sub>8</sub>	
24	86.0	7	0.938
	96.0	7 <sup>1</sup> / <sub>4</sub>	
	80.0	7	
24	90.0	7 <sup>1</sup> / <sub>8</sub>	0.875
	100.0	7 <sup>1</sup> / <sub>4</sub>	

## W Shapes



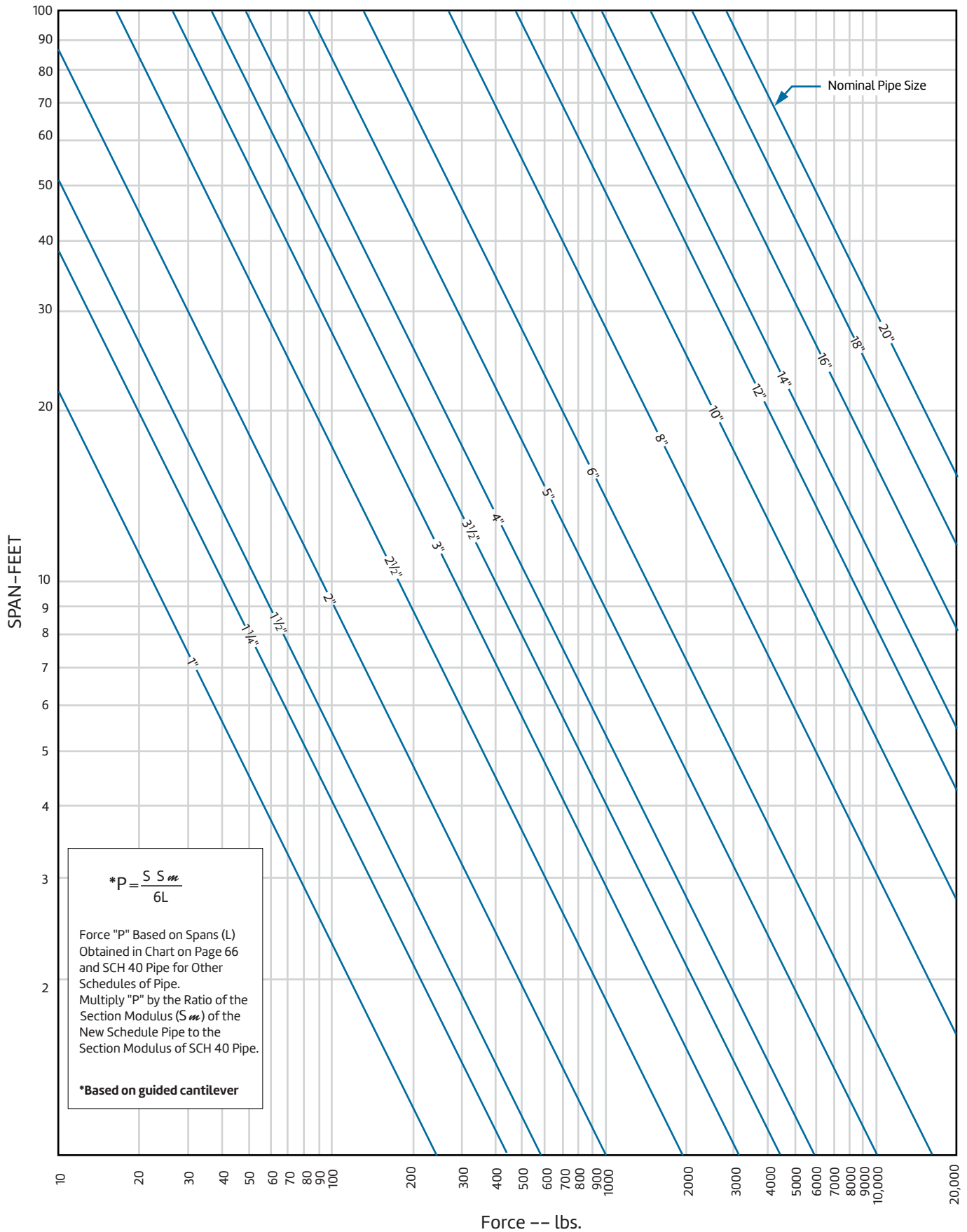
Y in	Wt. / Ft. lb	Width in	Z in	Y in	Wt. / Ft. lb	Width in	Z in
5	19.0	5	0.430	16	36.0	7	0.430
6	25.0	6 <sup>1</sup> / <sub>8</sub>	0.455		40.0	7	0.505
	8	18.0	5 <sup>1</sup> / <sub>4</sub>	0.33	45.0	7	0.565
10		21.0	5 <sup>1</sup> / <sub>4</sub>	0.400	50.0	7 <sup>1</sup> / <sub>8</sub>	0.630
	12	24.0	6 <sup>1</sup> / <sub>2</sub>	0.400	57.0	7 <sup>1</sup> / <sub>8</sub>	0.715
14		28.0	6 <sup>1</sup> / <sub>2</sub>	0.465	67.0	10 <sup>1</sup> / <sub>4</sub>	0.665
	16	31.0	8	0.435	77.0	10 <sup>1</sup> / <sub>4</sub>	0.760
18		35.0	8	0.495	89.0	10 <sup>3</sup> / <sub>8</sub>	0.875
	20	40.0	8 <sup>1</sup> / <sub>8</sub>	0.560	100.0	10 <sup>3</sup> / <sub>8</sub>	0.985
22		48.0	8 <sup>1</sup> / <sub>8</sub>	0.685	50.0	7 <sup>1</sup> / <sub>2</sub>	0.570
	24	58.0	8 <sup>1</sup> / <sub>4</sub>	0.810	55.0	7 <sup>1</sup> / <sub>2</sub>	0.630
26		67.0	8 <sup>1</sup> / <sub>4</sub>	0.935	60.0	7 <sup>1</sup> / <sub>2</sub>	0.695
	28	22.0	5 <sup>3</sup> / <sub>4</sub>	0.360	65.0	7 <sup>5</sup> / <sub>8</sub>	0.750
30		26.0	5 <sup>3</sup> / <sub>4</sub>	0.440	71.0	7 <sup>5</sup> / <sub>8</sub>	0.810
	32	30.0	5 <sup>3</sup> / <sub>4</sub>	0.510	76.0	11	0.680
34		33.0	8	0.435	86.0	11 <sup>1</sup> / <sub>8</sub>	0.770
	36	39.0	8	0.530	97.0	11 <sup>1</sup> / <sub>8</sub>	0.870
38		45.0	8	0.620	106.0	11 <sup>1</sup> / <sub>4</sub>	0.940
	40	49.0	10	0.560	62.0	8 <sup>1</sup> / <sub>4</sub>	0.615
42		54.0	10	0.615	68.0	8 <sup>1</sup> / <sub>4</sub>	0.685
	44	60.0	10 <sup>1</sup> / <sub>8</sub>	0.680	73.0	8 <sup>1</sup> / <sub>4</sub>	0.740
46		68.0	10 <sup>1</sup> / <sub>8</sub>	0.770	83.0	8 <sup>3</sup> / <sub>8</sub>	0.835
	48	77.0	10 <sup>1</sup> / <sub>4</sub>	0.870	93.0	12 <sup>1</sup> / <sub>4</sub>	0.930
50		88.0	10 <sup>1</sup> / <sub>4</sub>	0.990	101.0	12 <sup>3</sup> / <sub>8</sub>	0.800
	52	26.0	6 <sup>1</sup> / <sub>2</sub>	0.380	111.0	12 <sup>3</sup> / <sub>8</sub>	0.875
54		30.0	6 <sup>1</sup> / <sub>2</sub>	0.440	122.0	12 <sup>3</sup> / <sub>8</sub>	0.960
	56	40.0	8	0.515	76.0	9	0.680
58		50.0	8	0.575	84.0	9	0.770
	60	53.0	8 <sup>1</sup> / <sub>8</sub>	0.640	94.0	9 <sup>1</sup> / <sub>8</sub>	0.875
62		58.0	10	0.575	104.0	12 <sup>3</sup> / <sub>4</sub>	0.750
	64	65.0	12	0.605	117.0	12 <sup>3</sup> / <sub>4</sub>	0.850
66		72.0	12	0.670	131.0	12 <sup>7</sup> / <sub>8</sub>	0.960
	68	79.0	12 <sup>1</sup> / <sub>8</sub>	0.735	94.0	10	0.745
70		87.0	12 <sup>1</sup> / <sub>8</sub>	0.810	102.0	10	0.830
	72	96.0	12 <sup>1</sup> / <sub>8</sub>	0.900	114.0	10 <sup>1</sup> / <sub>8</sub>	0.930
74		106.0	12 <sup>1</sup> / <sub>4</sub>	0.990	146.0	14	0.975
	76	30.0	6 <sup>3</sup> / <sub>4</sub>	0.385	108.0	10 <sup>1</sup> / <sub>2</sub>	0.760
78		34.0	6 <sup>3</sup> / <sub>4</sub>	0.455	116.0	10 <sup>1</sup> / <sub>2</sub>	0.850
	80	38.0	6 <sup>3</sup> / <sub>4</sub>	0.515	124.0	10 <sup>1</sup> / <sub>2</sub>	0.930
82		43.0	8	0.530	132.0	10 <sup>1</sup> / <sub>2</sub>	1.000
	84	48.0	8	0.595	118.0	11 <sup>1</sup> / <sub>2</sub>	0.740
86		53.0	8	0.660	130.0	11 <sup>1</sup> / <sub>2</sub>	0.855
	88	61.0	10	0.645	141.0	11 <sup>1</sup> / <sub>2</sub>	0.960
90		68.0	10	0.720	135.0	12	0.790
	92	74.0	10 <sup>1</sup> / <sub>8</sub>	0.785	150.0	12	0.940
94		82.0	10 <sup>1</sup> / <sub>8</sub>	0.855	168.0	12	1.020
	96	90.0	14 <sup>1</sup> / <sub>2</sub>	0.710			
98		99.0	14 <sup>3</sup> / <sub>8</sub>	0.780			
	100	109.0	14 <sup>3</sup> / <sub>8</sub>	0.860			
102		120.0	14 <sup>3</sup> / <sub>8</sub>	0.940			
	104	132.0	14 <sup>3</sup> / <sub>4</sub>	1.030			



asc-es.com

Building connections that last™

# Force Based on Span





## Pressure Conversions

To convert C° to F°, find C° value in the middle column and read F° in right hand column.  
 To convert F° to C°, find F° value in the middle column and read C° in left hand column.

PSI	Feet of Water		PSI	Feet of Water		PSI	Feet of Water		PSI	Feet of Water		PSI	Feet of Water	
0.43	1	2.31	28.14	65	150.15	55.84	129	297.99	83.55	193	445.83	111.26	257	593.67
0.87	2	4.62	28.57	66	152.46	56.28	130	300.3	83.98	194	448.14	111.69	258	595.98
1.30	3	6.93	29.00	67	154.77	56.71	131	302.61	84.42	195	450.45	112.12	259	598.29
1.73	4	9.24	29.44	68	157.08	57.14	132	304.92	84.85	196	452.76	112.55	260	600.6
2.16	5	11.55	29.87	69	159.39	57.58	133	307.23	85.28	197	455.07	112.99	261	602.91
2.6	6	13.86	30.3	70	161.7	58.01	134	309.54	85.71	198	457.38	113.42	262	605.22
3.03	7	16.17	30.74	71	164.01	58.44	135	311.85	86.15	199	459.69	113.85	263	607.53
3.46	8	18.48	31.17	72	166.32	58.87	136	314.16	86.58	200	462	114.29	264	609.84
3.9	9	20.79	31.60	73	168.63	59.31	137	316.47	87.01	201	464.31	114.72	265	612.15
4.33	10	23.1	32.03	74	170.94	59.74	138	318.78	87.45	202	466.62	116.88	270	623.7
4.76	11	25.41	32.47	75	173.25	60.17	139	321.09	87.88	203	468.93	119.05	275	635.25
5.19	12	27.72	32.9	76	175.56	60.61	140	323.4	88.31	204	471.24	121.21	280	646.8
5.63	13	30.03	33.33	77	177.87	61.04	141	325.71	88.74	205	473.55	123.38	285	658.35
6.06	14	32.34	33.77	78	180.18	61.47	142	328.02	89.18	206	475.86	125.54	290	669.9
6.49	15	34.65	34.2	79	182.49	61.9	143	330.33	89.61	207	478.17	127.71	295	681.45
6.93	16	36.96	34.63	80	184.8	62.34	144	332.64	90.04	208	480.48	129.87	300	693
7.36	17	39.27	35.06	81	187.11	62.77	145	334.95	90.48	209	482.79	132.03	305	704.55
7.79	18	41.58	35.5	82	189.42	63.2	146	337.26	90.91	210	485.1	134.2	310	716.1
8.23	19	43.89	35.93	83	191.73	63.64	147	339.57	91.34	211	487.41	136.36	315	727.65
8.66	20	46.2	36.36	84	194.04	64.07	148	341.88	91.77	212	489.72	138.53	320	739.20
9.09	21	48.51	36.8	85	196.35	64.5	149	344.19	92.21	213	492.03	140.69	325	750.75
9.52	22	50.82	37.23	86	198.66	64.94	150	346.5	92.64	214	494.34	142.86	330	762.30
9.96	23	53.13	37.66	87	200.97	65.37	151	348.81	93.07	215	496.65	145.02	335	773.85
10.39	24	55.44	38.10	88	203.28	65.8	152	351.12	93.51	216	498.96	147.19	340	785.40
10.82	25	57.75	38.53	89	205.59	66.23	153	353.43	93.94	217	501.27	149.35	345	796.95
11.26	26	60.06	38.96	90	207.9	66.67	154	355.74	94.37	218	503.58	151.52	350	808.50
11.69	27	62.37	39.39	91	210.21	67.1	155	358.05	94.81	219	505.89	153.68	355	820.05
12.12	28	64.68	39.83	92	212.52	67.53	156	360.36	95.24	220	508.2	155.84	360	831.60
12.55	29	66.99	40.26	93	214.83	67.97	157	362.67	95.67	221	510.51	158.01	365	843.15
12.99	30	69.3	40.69	94	217.14	68.4	158	364.98	96.10	222	512.82	160.17	370	854.70
13.42	31	71.61	41.13	95	219.45	68.83	159	367.29	96.54	223	515.13	162.34	375	866.25
13.85	32	73.92	41.56	96	221.76	69.26	160	369.6	96.97	224	517.44	164.5	380	877.80
14.29	33	76.23	41.99	97	224.07	69.7	161	371.91	97.40	225	519.75	166.67	385	889.35
14.72	34	78.54	42.42	98	226.38	70.13	162	374.22	97.84	226	522.06	168.83	390	900.9
15.15	35	80.85	42.86	99	228.69	70.56	163	376.53	98.27	227	524.37	171.00	395	912.45
15.58	36	83.16	43.29	100	231	71	164	378.84	98.7	228	526.68	173.16	400	924
16.02	37	85.47	43.72	101	233.31	71.43	165	381.15	99.13	229	528.99	183.98	425	981.75
16.45	38	87.78	44.16	102	235.62	71.86	166	383.46	99.57	230	531.3	194.81	450	1,040
16.88	39	90.09	44.59	103	237.93	72.29	167	385.77	100.00	231	533.61	205.63	475	1,097
17.32	40	92.4	45.02	104	240.24	72.73	168	388.08	100.43	232	535.92	216.45	500	1,155
17.75	41	94.71	45.45	105	242.55	73.16	169	390.39	100.87	233	538.23	227.27	525	1,213
18.18	42	97.02	45.89	106	244.86	73.59	170	392.7	101.30	234	540.54	238.10	550	1,271
18.61	43	99.33	46.32	107	247.17	74.03	171	395.01	101.73	235	542.85	248.92	575	1,328
19.05	44	101.64	46.75	108	249.48	74.46	172	397.32	102.16	236	545.16	259.74	600	1,386
19.48	45	103.95	47.19	109	251.79	74.89	173	399.63	102.6	237	547.47	270.56	625	1,444
19.91	46	106.26	47.62	110	254.1	75.32	174	401.94	103.03	238	549.78	281.39	650	1,502
20.35	47	108.57	48.05	111	256.41	75.76	175	404.25	103.46	239	552.09	292.21	675	1,559
20.78	48	110.88	48.48	112	258.72	76.19	176	406.56	103.90	240	554.4	303.03	700	1,617
21.21	49	113.19	48.92	113	261.03	76.62	177	408.87	104.33	241	556.71	313.85	725	1,675
21.65	50	115.5	49.35	114	263.34	77.06	178	411.18	104.76	242	559.02	324.68	750	1,733
22.08	51	117.81	49.78	115	265.65	77.49	179	413.49	105.19	243	561.33	335.50	775	1,790
22.51	52	120.12	50.22	116	267.96	77.92	180	415.8	105.63	244	563.64	346.32	800	1,848
22.94	53	12.43	50.65	117	270.27	78.35	181	418.11	106.06	245	565.95	357.14	825	1,906
23.38	54	124.74	51.08	118	272.58	78.79	182	420.42	106.49	246	568.26	367.97	850	1,964
23.81	55	127.05	51.52	119	274.89	79.22	183	422.73	106.93	247	570.57	378.79	875	2,021
24.24	56	129.36	51.95	120	277.2	79.65	184	425.04	107.36	248	572.88	389.61	900	2,079
24.68	57	131.67	52.38	121	279.51	80.09	185	427.35	107.79	249	575.19	400.43	925	2,137
25.11	58	133.98	52.81	12	281.82	80.52	186	429.66	108.23	250	577.5	411.26	950	2,195
25.54	59	136.29	53.25	123	284.13	80.95	187	431.97	108.66	251	579.81	422.08	975	2,252
25.97	60	138.6	53.68	124	286.44	81.39	188	434.28	109.09	252	582.12	432.9	1000	2,310
26.41	61	140.91	54.11	125	288.75	81.82	189	436.59	109.52	253	584.43	649.4	1500	3,465
26.84	62	143.22	54.55	126	291.06	82.25	190	438.9	109.96	254	586.74	865.8	2000	4,620
27.27	63	145.53	54.98	127	293.37	82.68	191	441.21	110.39	255	589.05	1,082	2500	5,780
27.71	64	147.84	55.41	128	295.68	83.12	192	443.52	110.82	256	591.36	1,300	3000	6,930

# Properties of Water, Fractional Conversions

## Properties of Water at Saturation Pressure

Temp °F	Saturation Pressure PSI (abs)	Density lb/ft <sup>3</sup>	Density lb/gallon	Covert Factor ft. of water to PSI	Absolute Viscosity lb./sec. ft.
32	0.0885	62.42	8.346	2.307	0.001203
40	0.1217	62.43	8.347	2.307	0.001042
50	0.1781	62.41	8.344	2.307	0.000880
60	0.2563	62.37	8.339	2.309	0.000753
70	0.3631	62.30	8.33	2.311	0.000657
80	0.5069	62.22	8.319	2.315	0.000579
90	0.6982	62.12	8.305	2.318	0.000513
100	0.9492	62.00	8.289	2.323	0.000460
110	1.275	61.84	8.268	2.328	0.000415
120	1.692	61.73	8.253	2.333	0.000376
130	2.222	61.54	8.228	2.34	0.000343
140	2.889	61.39	8.208	2.346	0.000316
150	3.718	61.2	8.182	2.353	0.000290
160	4.741	61.01	8.157	2.36	0.000269
170	5.992	60.79	8.128	2.369	0.000250
180	7.51	60.57	8.098	2.377	0.000233
190	9.339	60.35	8.069	2.386	0.000218
200	11.53	60.13	8.039	2.395	0.000205
210	14.12	59.88	8.006	2.405	0.0001930
212	14.696	59.81	7.997	2.408	0.0001910
220	17.19	59.63	7.973	2.415	0.0001810
230	20.78	59.38	7.939	2.425	0.0001710
240	24.97	59.10	7.902	2.436	0.0001630
250	29.82	58.82	7.864	2.448	0.0001540
275	45.42	58.09	7.767	2.479	0.0001360
300	67.01	57.31	7.662	2.513	0.0001240
350	134.6	55.59	7.432	2.591	0.0001080
400	247.3	53.65	7.173	2.684	0.0000874
450	422.6	51.55	6.892	2.793	0.0000806
500	680.8	49.02	6.554	2.938	0.0000672
550	1045	45.87	6.133	3.139	0.0000605
600	1543	42.37	5.665	3.399	0.0000538
650	2208	37.31	4.988	3.86	0.0000470
700	3094	27.10	3.623	5.314	0.0000269

## Decimal -- Inch -- Foot -- Measurement

Decimal Equiv.	Inch
0.001312	1/64"
0.002604	1/32"
0.003906	3/64"
0.005208	1/16"
0.006510	5/64"
0.007813	3/32"
0.009115	7/64"
0.010417	1/8"
0.011719	9/64"
0.013021	5/32"
0.014323	11/64"
0.015625	3/16"
0.016927	13/64"
0.018229	7/32"
0.019531	15/64"
0.020833	1/4"
0.022135	17/64"
0.023438	9/32"
0.024740	19/64"
0.026042	5/16"
0.027344	21/64"
0.028646	11/32"
0.029948	23/64"
0.031250	3/8"
0.032552	25/64"
0.033854	13/32"
0.035156	27/64"
0.036458	7/16"
0.037760	29/64"
0.039063	15/32"
0.040365	31/64"
0.041667	1/2"

## Decimal -- Inch -- Foot -- Measurement

Decimal Equiv.	Inch
0.042969	33/64"
0.044271	17/32"
0.045573	35/64"
0.046875	9/16"
0.048177	37/64"
0.049479	19/32"
0.050781	39/64"
0.052083	5/8"
0.053385	41/64"
0.054688	21/32"
0.055990	43/64"
0.057292	11/16"
0.058594	45/64"
0.059896	23/32"
0.061198	47/64"
0.062500	3/4"
0.063802	49/64"
0.065104	25/32"
0.066406	51/64"
0.067708	13/16"
0.069010	53/64"
0.070313	27/32"
0.071615	55/64"
0.072917	7/8"
0.074219	57/64"
0.075521	29/32"
0.076823	59/64"
0.078125	15/16"
0.079427	61/64"
0.080729	31/32"
0.082031	63/64"
0.083333	1"

## Decimal -- Inch -- Foot -- Measurement

Decimal Equiv.	Inch
0.166667	2"
0.250000	3"
0.333333	4"
0.416667	5"
0.500000	6"
0.583333	7"
0.666667	8"
0.750000	9"
0.833333	10"
0.916667	11"
1.000000	12"

## Decimal Equivalent / Fraction

Decimal Equiv.	Fraction
0.015625	1/64
0.031250	1/32
0.046875	3/64
0.062500	1/16
0.078125	5/64
0.093750	3/32
0.109375	7/64
0.125000	1/8
0.140625	9/64
0.156250	5/32
0.171875	11/64
0.187500	3/16
0.203125	13/64
0.218750	7/32
0.234375	15/64
0.250000	1/4

## Decimal Equivalent / Fraction

Decimal Equiv.	Fraction
0.296875	17/64
0.281250	9/32
0.296875	19/64
0.312500	5/16
0.328125	21/64
0.343750	11/32
0.359375	23/64
0.375000	3/8
0.390625	25/64
0.406250	13/32
0.421875	27/64
0.437500	7/16
0.453125	29/64
0.468750	15/32
0.484375	31/64
0.500000	1/2

## Decimal Equivalent / Fraction

Decimal Equiv.	Fraction
0.515625	33/64
0.531250	17/32
0.546875	35/64
0.562500	9/16
0.578125	37/64
0.593750	19/32
0.609375	39/64
0.625000	5/8
0.640625	41/64
0.656250	21/32
0.671875	43/64
0.687500	11/16
0.703125	45/64
0.718750	22/32
0.734375	47/64
0.750000	3/4

## Decimal Equivalent / Fraction

Decimal Equiv.	Fraction
0.765625	49/64
0.781250	25/32
0.796875	51/64
0.812500	13/16
0.828125	53/64
0.843750	27/32
0.859375	55/64
0.875000	7/8
0.890625	57/64
0.906250	29/32
0.921875	59/64
0.937500	15/16
0.953125	61/64
0.968750	31/32
0.984375	63/64
1.000000	1

## Metric Conversion Table

Inch	Millimeters
0	0
1/128	0.01984375
1/64	0.396875
3/128	5953125
1/32	0.79375
5/128	0.9921875
3/64	1.190625
7/128	1.3890625
1/16	1.5875
1/8	3.175
3/16	4.7625
1/4	6.35
5/16	7.9375
3/8	9.525
7/16	11.1125
1/2	12.7
9/16	14.2875
5/8	15.875
11/16	17.4625
3/4	19.05
13/16	20.6375
7/8	22.225
15/16	23.8125
1	25.4
1 1/16	26.9875
1 1/8	28.575
1 1/4	30.1625
1 1/2	31.75
1 5/8	33.3375
1 3/4	34.925
1 7/8	36.5125
1 1/2	38.1
1 9/16	39.6875
1 5/8	41.275
1 11/16	42.8625
1 3/4	44.45
1 13/16	46.0375
1 7/8	47.625
1 15/16	49.2125
2	50.8

Example:

Convert 3.7664 meters to feet, inches and fractions  
 Using the feet to meter table, 12 ft. = 3.6576  
 So now convert 3.7664m - 3.6576m = 108.8mm  
 Using the inch to millimeter table, 4 1/4 in. = 107.95mm  
 So now convert 108.8mm - 107.95mm = 0.85mm  
 Using the inch to millimeter table, 1/32 = 0.79375

Example:

Convert 15 ft. 67/16 in. to meters  
 Using the feet to meter table, 15 ft. = 4.572 meters  
 Using the inch to millimeter table, 67/16 in. = .1635125 meters  
 Thus, 15 ft. 67/16 in. = 4.7355125 meters

Inch	Millimeters	Inch	Millimeters	Inch	Millimeters	Inch	Millimeters	Inch	Millimeters
2 1/16	52.3875	4 1/16	103.1875	6 1/16	153.9875	8 1/16	204.7875	10 1/16	255.5875
2 1/8	53.975	4 1/8	104.775	6 1/8	155.575	8 1/8	206.375	10 1/8	257.175
2 3/16	55.5625	4 3/16	106.3625	6 3/16	157.1625	8 3/16	207.9625	10 3/16	258.7625
2 1/4	57.15	4 1/4	107.95	6 1/4	158.75	8 1/4	209.55	10 1/4	260.35
2 5/16	58.7375	4 5/16	109.5375	6 5/16	160.3375	8 5/16	211.1375	10 5/16	261.9375
2 3/8	60.325	4 3/8	111.125	6 3/8	161.925	8 3/8	212.725	10 3/8	263.525
2 7/16	61.9125	4 7/16	112.7125	6 7/16	163.5125	8 7/16	214.3125	10 7/16	265.1125
2 1/2	63.5	4 1/2	114.3	6 1/2	165.1	8 1/2	215.9	10 1/2	266.7
2 9/16	65.0875	4 9/16	115.8875	6 9/16	166.6875	8 9/16	217.4875	10 9/16	268.2875
2 5/8	66.675	4 5/8	117.475	6 5/8	168.275	8 5/8	219.075	10 5/8	269.875
2 11/16	68.2625	4 11/16	119.0625	6 11/16	169.8625	8 11/16	220.6625	10 11/16	271.4625
2 3/4	69.85	4 3/4	120.65	6 3/4	171.45	8 3/4	222.25	10 3/4	273.05
2 13/16	71.4375	4 13/16	122.2375	6 13/16	173.0375	8 13/16	223.8375	10 13/16	274.6375
2 7/8	73.025	4 7/8	123.825	6 7/8	174.625	8 7/8	225.425	10 7/8	276.225
2 15/16	74.6125	4 15/16	125.4125	6 15/16	176.2125	8 15/16	227.0125	10 15/16	277.8125
3	76.2	5	127	7	177.8	9	228.6	11	279.4
3 1/16	77.7875	5 1/16	128.5875	7 1/16	179.3875	9 1/16	230.1875	11 1/16	280.9875
3 1/8	79.375	5 1/8	130.175	7 1/8	180.975	9 1/8	231.775	11 1/8	282.575
3 1/4	80.9625	5 1/4	131.7625	7 1/4	182.5625	9 1/4	233.3625	11 1/4	284.1625
3 3/8	82.55	5 3/8	133.35	7 3/8	184.15	9 3/8	234.95	11 3/8	285.75
3 5/16	84.1375	5 5/16	134.9375	7 5/16	185.7375	9 5/16	236.5375	11 5/16	287.3375
3 3/8	85.725	5 3/8	136.525	7 3/8	187.325	9 3/8	238.125	11 3/8	288.925
3 7/16	87.3125	5 7/16	138.1125	7 7/16	188.9125	9 7/16	239.7125	11 7/16	290.5125
3 1/2	88.9	5 1/2	139.7	7 1/2	190.5	9 1/2	241.3	11 1/2	292.1
3 9/16	90.4875	5 9/16	141.2875	7 9/16	192.0875	9 9/16	242.8875	11 9/16	293.6875
3 5/8	92.075	5 5/8	142.875	7 5/8	193.675	9 5/8	244.475	11 5/8	295.275
3 11/16	93.6625	5 11/16	144.4625	7 11/16	195.2625	9 11/16	246.0625	11 11/16	296.8625
3 3/4	95.25	5 3/4	146.05	7 3/4	196.85	9 3/4	247.65	11 3/4	298.45
3 13/16	96.8375	5 13/16	147.6375	7 13/16	198.4375	9 13/16	249.2375	11 13/16	300.0375
3 7/8	98.425	5 7/8	149.225	7 7/8	200.025	9 7/8	250.825	11 7/8	301.625
3 15/16	100.0125	5 15/16	150.8125	7 15/16	201.6125	9 15/16	252.4125	11 15/16	303.2125
4	101.6	6	152.4	8	203.2	10	254	12	304.8

Feet	Meters	Feet	Meters	Feet	Meters	Feet	Meters	Feet	Meters
1	0.3048	21	6.4008	41	12.4968	61	18.5928	81	24.6888
2	0.6096	22	6.7056	42	12.8016	62	18.8976	82	24.9936
3	0.9144	23	7.0104	43	13.1064	63	19.2024	83	25.2984
4	1.2192	24	7.3152	44	13.4112	64	19.5072	84	25.6032
5	1.5240	25	7.6200	45	13.7160	66	19.8120	85	25.908
6	1.8288	26	7.9248	46	14.0208	66	20.1168	86	26.2128
7	2.1336	27	8.2296	47	14.3256	67	20.4216	87	26.5176
8	2.4384	28	8.5344	48	14.6304	68	20.7264	88	26.8224
9	2.7432	29	8.8392	49	14.9352	69	21.0312	89	27.1272
10	3.0480	30	9.1440	50	15.2400	70	21.3360	90	27.4320
11	3.3528	31	9.4488	51	15.5448	71	21.6408	91	27.7368
12	3.6576	32	9.7536	52	15.8496	72	21.9456	92	28.0416
13	3.9624	33	10.0584	53	16.1544	73	22.2504	93	28.3464
14	4.2672	34	10.3632	54	16.4592	74	22.5552	94	28.6512
15	4.5720	35	10.6680	55	16.7640	75	22.8600	95	28.9560
16	4.8768	36	10.9728	56	17.0688	76	23.1648	96	29.2608
17	5.1816	37	11.2776	57	17.3736	77	23.4696	97	29.5656
18	5.4864	38	11.5824	58	17.6784	78	23.7744	98	29.8704
19	5.7912	39	11.8872	59	17.9832	79	24.0792	99	30.1752
20	6.0960	40	12.1920	60	18.2880	80	24.3840	100	30.4800

# Properties of Pipe

The following formulas are used in the computation of the values shown in the table:

† weight of pipe per foot (pounds) =  $10.6802t(D - t)$   
 weight of water per foot (pounds) =  $0.3405 \times d^2$   
 square feet outside surface per foot =  $\pi/12 \times D$   
 square feet inside surface per foot =  $\pi/12 \times d$   
 inside area (square inches) =  $\pi/4 \times d^2$   
 area of metal (square inches) =  $\pi/4 \times (D^2 - d^2)$   
 moment of inertia (inches<sup>4</sup>) =  $\pi/64 \times (D^4 - d^4) = A_m R_g^2$   
 section modulus (inches<sup>3</sup>) =  $\pi/32 \times (D^4 - d^4)/D$   
 radius of gyration (inches) =  $\sqrt{(D^2 - d^2)/4}$

Where:

$A_m$  = area of metal (square inches)

$d$  = inside diameter (inches)

$D$  = outside diameter (inches)

$R_g$  = radius of gyration (inches)

$t$  = pipewall thickness (inches)

Note:

† The ferritic steels may be about 5% less, and the austenitic stainless steels about 2% greater than the values shown in this table which are based on weights for carbon steel.

\* Schedule Numbers

Standard weight pipe and schedule 40 are the same in all sizes through 10-inch through 24-inch, standard weight pipe has a wall thickness of  $\frac{3}{8}$ -inch.

Extra strong weight pipe and schedule 80 are the same in all sizes through 8-inch; from 8-inch through 24-inch, extra strong weight pipe has a wall thickness of  $\frac{1}{2}$ -inch.

Double extra strong weight pipe has no corresponding schedule number.

a: ANSI B36.10 steel pipe schedule numbers

b: ANSI B36.10 steel pipe nominal wall thickness designation

c: ANSI B36.19 stainless steel pipe schedule numbers

## Pressure Conversions

Nom. Pipe Size, O.D. Inches	Schedule Number*			Wall Thickness Inch	Inside Diameter Inch	Inside Area Sq. In.	Metal Area Sq. In.	Outside Surface Sq. Ft./ Ft.	Inside Surface Sq. Ft./ Ft.	Weight per Foot Lbs. †	Weight of Water per Foot Lbs.	Moment of Inertia In. <sup>4</sup>	Section Modulus In. <sup>3</sup>	Radius Gyration <sup>4</sup> In.
	a	b	c											
1/8 0.4050	-	-	10S	0.049	0.307	0.0740	0.0548	0.106	0.0804	0.186	0.0321	0.00088	0.00437	0.1271
	40	STD	40S	0.068	0.269	0.0568	0.0720	0.106	0.0704	0.245	0.0246	0.00106	0.00525	0.1215
	80	XS	80S	0.095	0.215	0.0363	0.0925	0.106	0.0563	0.315	0.0157	0.00122	0.0060	0.1146
1/4 0.5400	-	-	10S	0.065	0.410	0.1320	0.0970	0.141	0.1073	0.33	0.0572	0.00279	0.0103	0.1695
	40	STD	40S	0.088	0.364	0.1040	0.1250	0.141	0.0953	0.425	0.0451	0.00331	0.01230	0.1628
	80	XS	80S	0.119	0.302	0.0720	0.1570	0.141	0.0791	0.535	0.0311	0.00377	0.0139	0.1547
3/8 0.6750	-	-	10S	0.065	0.545	0.2330	0.1250	0.177	0.1427	0.423	0.1011	0.00586	0.0174	0.2169
	40	STD	40S	0.091	0.493	0.1910	0.1670	0.177	0.1291	0.568	0.0828	0.00729	0.0216	0.209
	80	XS	80S	0.126	0.423	0.1410	0.2170	0.177	0.1107	0.739	0.0609	0.00862	0.0255	0.1991
1/2 0.8400	-	-	5S	0.065	0.710	0.3960	0.1580	0.22	0.1859	0.538	0.172	0.01197	0.0285	0.275
	-	-	10S	0.083	0.674	0.3570	0.1970	0.22	0.1765	0.671	0.155	0.01431	0.0341	0.2692
	40	STD	40s	0.109	0.622	0.3040	0.2500	0.22	0.1628	0.851	0.132	0.01709	0.0407	0.2613
3/4 1.0500	80	XS	80s	0.147	0.546	0.2340	0.3200	0.22	0.1429	1.09	0.102	0.02008	0.0478	0.2505
	160	-	-	0.187	0.466	0.1710	0.3840	0.22	0.1220	1.30	0.074	0.02212	0.0527	0.2402
	-	XXS	-	0.294	0.252	0.0500	0.5040	0.22	0.0660	1.71	0.022	0.02424	0.0577	0.2192
1 1.3150	-	-	5S	0.065	0.920	0.6650	0.2010	0.275	0.2409	0.684	0.288	0.0245	0.0467	0.349
	-	-	10S	0.083	0.884	0.6140	0.2520	0.275	0.2314	0.857	0.266	0.02969	0.0566	0.3430
	40	STD	40S	0.113	0.824	0.5330	0.3330	0.275	0.2157	1.130	0.231	0.03704	0.0705	0.3340
1 1/4 1.6600	80	XS	80S	0.154	0.742	0.4320	0.4330	0.275	0.1943	1.470	0.187	0.04479	0.0853	0.3210
	160	-	-	0.218	0.614	0.2960	0.5700	0.275	0.1607	1.94	0.128	0.05269	0.1004	0.3040
	-	XXS	-	0.308	0.434	0.1480	0.7180	0.275	0.1136	2.44	0.064	0.05792	0.1103	0.2840
1 1/2 1.8750	-	-	5S	0.065	1.185	1.1030	0.2550	0.344	0.3102	0.868	0.478	0.04999	0.0760	0.4430
	-	-	10S	0.109	1.097	0.9450	0.4130	0.344	0.2872	1.40	0.41	0.07569	0.1151	0.4280
	40	STD	40S	0.133	1.049	0.8640	0.4940	0.344	0.2746	1.68	0.375	0.08734	0.1328	0.4210
2 2.0700	80	XS	80S	0.179	0.957	0.7190	0.6390	0.344	0.2505	2.17	0.312	0.10561	0.1606	0.4070
	160	-	-	0.250	0.815	0.5220	0.8360	0.344	0.2134	2.84	0.226	0.12512	0.1903	0.3870
	-	XXS	-	0.358	0.599	0.2820	1.0760	0.344	0.1568	3.66	0.122	0.14046	0.2136	0.3610
2 1/2 2.6250	-	-	5S	0.065	1.530	1.8390	0.3260	0.435	0.4006	1.11	0.797	0.10375	0.1250	0.5640
	-	-	10S	0.109	1.442	1.6330	0.5310	0.435	0.3775	1.81	0.708	0.16049	0.1934	0.5500
	40	STD	40S	0.140	1.380	1.4960	0.6690	0.435	0.3613	2.27	0.648	0.19471	0.2346	0.5400
3 3.1500	80	XS	80S	0.191	1.278	1.2830	0.8810	0.435	0.3346	3.00	0.556	0.24179	0.2913	0.5240
	160	-	-	0.250	1.160	1.0570	1.1070	0.435	0.3037	3.76	0.458	0.28386	0.342	0.5060
	-	XXS	-	0.382	0.896	0.6310	1.5340	0.435	0.2346	5.21	0.273	0.34110	0.4110	0.4720

## Properties of Pipe

Nom. Pipe Size, O.D. Inches	Schedule Number*			Wall Thickness Inch	Inside Diameter Inch	Inside Area Sq. In.	Metal Area Sq. In.	Outside Surface Sq. Ft./ Ft.	Inside Surface Sq. Ft./ Ft.	Weight per Foot Lbs. †	Weight of Water per Foot Lbs.	Moment of Inertia In. <sup>4</sup>	Section Modulus In. <sup>3</sup>	Radius Gyration <sup>4</sup> In.
	a	b	c											
1½ 1.9000	-	-	5S	0.065	1.770	2.461	0.375	0.497	0.4634	1.27	1.067	0.15792	0.1662	0.649
	-	-	10S	0.109	1.682	2.222	0.613	0.497	0.4403	2.08	0.963	0.24682	0.2598	0.634
	40	Std	40s	0.145	1.610	2.036	0.799	0.497	0.4215	2.72	0.883	0.30989	0.3262	0.623
	80	XS	80s	0.200	1.500	1.767	1.068	0.497	0.3927	3.63	0.766	0.39121	0.4118	0.605
	-	-	-	0.281	1.338	1.406	1.429	0.497	0.3503	4.86	0.61	0.48239	0.5078	0.581
	-	-	-	0.400	1.100	0.95	1.885	0.497	0.288	6.41	0.412	0.56784	0.5977	0.549
	-	-	-	0.525	0.850	0.567	2.268	0.497	0.2225	7.71	0.246	0.61409	0.6464	0.52
	-	-	-	0.650	0.600	0.283	2.553	0.497	0.1571	8.68	0.123	0.63335	0.6667	0.498
2 2.3750	-	-	5S	0.065	2.245	3.958	0.472	0.622	0.5877	1.60	1.716	0.31489	0.2652	0.817
	40	Std	10S	0.109	2.157	3.654	0.776	0.622	0.5647	2.64	1.584	0.49919	0.4204	0.802
	80	XS	40s	0.154	2.067	3.356	1.075	0.622	0.5411	3.65	1.455	0.66575	0.5606	0.787
	160	-	80s	0.218	1.939	2.953	1.477	0.622	0.5076	5.02	1.28	0.86792	0.7309	0.766
	-	XSS	-	0.343	1.689	2.241	2.19	0.622	0.4422	7.44	0.971	1.16232	0.9788	0.729
	-	-	-	0.436	1.503	1.774	2.656	0.622	0.3935	9.03	0.769	1.3113	1.104	0.703
	-	-	-	0.562	1.251	1.229	3.201	0.622	0.3275	10.90	0.533	1.44157	1.214	0.671
	-	-	-	0.687	1.001	0.787	3.643	0.622	0.2621	12.40	0.341	1.51251	1.274	0.644
2½ 2.8750	-	-	5S	0.083	2.709	5.764	0.728	0.753	0.7092	2.47	2.499	0.71002	0.4939	0.988
	40	Std	10S	0.120	2.635	5.453	1.039	0.753	0.6898	3.53	2.364	0.98725	0.6868	0.975
	80	XS	40s	0.203	2.469	4.788	1.704	0.753	0.6464	5.79	2.076	1.52955	1.064	0.947
	160	-	80s	0.276	2.323	4.238	2.254	0.753	0.6082	7.66	1.837	1.92423	1.339	0.924
	-	XSS	-	0.375	2.125	3.547	2.945	0.753	0.5563	10.00	1.538	2.35274	1.637	0.894
	-	-	-	0.552	1.771	2.463	4.028	0.753	0.4636	13.70	1.068	2.87079	1.997	0.844
	-	-	-	0.675	1.525	1.827	4.665	0.753	0.3992	15.90	0.792	3.08819	2.148	0.814
	-	-	-	0.800	1.275	1.277	5.215	0.753	0.3338	17.70	0.554	3.22396	2.243	0.786
3 3.5000	-	-	5S	0.083	3.334	8.73	0.891	0.916	0.8728	3.030	3.785	1.30116	0.7435	1.208
	40	Std	10S	0.120	3.260	8.347	1.274	0.916	0.8535	4.330	3.619	1.82196	1.041	1.196
	80	XS	40s	0.216	3.068	7.393	2.228	0.916	0.8032	7.580	3.205	3.01716	1.724	1.164
	160	-	80s	0.300	2.900	6.605	3.016	0.916	0.7592	10.30	2.864	3.89432	2.225	1.136
	-	XSS	-	0.437	2.626	5.416	4.205	0.916	0.6875	14.30	2.348	5.03192	2.875	1.094
	-	-	-	0.600	2.300	4.155	5.466	0.916	0.6021	18.60	1.801	5.99251	3.424	1.047
	-	-	-	0.725	2.050	3.301	6.32	0.916	0.5367	21.00	1.431	6.49924	3.714	1.014
	-	-	-	0.850	1.800	2.545	7.076	0.916	0.4712	24.15	1.103	6.85088	3.915	0.984
3½ 4.0000	-	-	5S	0.083	3.834	11.545	1.021	1.050	1.004	3.470	5.005	1.95972	0.9799	1.385
	-	-	10S	0.120	3.760	11.104	1.463	1.050	0.9844	4.97	4.814	2.75519	1.378	1.372
	40	Std	40s	0.226	3.548	9.887	2.68	1.050	0.9289	9.110	4.286	4.78772	2.394	1.337
	89	XS	80s	0.318	3.364	8.888	3.678	1.050	0.8807	12.50	3.853	6.28009	3.14	1.307
	-	XXS	-	0.636	2.728	5.845	6.721	1.050	0.7142	22.90	2.534	9.84776	4.924	1.21
	-	-	5S	0.083	4.334	14.753	1.152	1.180	1.135	3.92	6.396	2.80979	1.249	1.562
	-	-	10S	0.120	4.260	14.253	1.651	1.180	1.115	5.61	6.179	3.96268	1.761	1.549
	-	-	-	0.188	4.124	13.358	2.547	1.180	1.08	8.66	5.791	5.93033	2.636	1.526
4 4.5000	40	Std	40S	0.237	4.026	12.73	3.174	1.180	1.054	10.80	5.519	7.2326	3.214	1.51
	80	XS	80S	0.337	3.826	11.497	4.407	1.180	1.002	15.00	4.984	9.61049	4.271	1.477
	120	-	-	0.437	3.626	10.326	5.578	1.180	0.9493	19.00	4.477	11.6433	5.175	1.445
	-	-	-	0.500	3.500	9.621	6.283	1.180	0.9163	21.4	4.171	12.7627	5.672	1.425
	160	-	-	0.531	3.438	9.283	6.621	1.180	0.9001	22.5	4.025	13.271	5.898	1.416
	-	XXS	-	0.674	3.152	7.803	8.101	1.180	0.8252	27.5	3.383	15.2837	6.793	1.374
	-	-	-	0.800	2.900	6.605	9.299	1.180	0.7592	31.6	2.864	16.657	7.403	1.338
	-	-	-	0.925	2.650	5.515	10.389	1.180	0.6938	35.3	2.391	17.7081	7.87	1.306



## Properties of Pipe

Nom. Pipe Size, O.D. Inches	Schedule Number*			Wall Thickness Inch	Inside Diameter Inch	Inside Area Sq. In.	Metal Area Sq. In.	Outside Surface Sq. Ft./ Ft.	Inside Surface Sq. Ft./ Ft.	Weight per Foot Lbs. †	Weight of Water per Foot Lbs.	Moment of Inertia In. <sup>4</sup>	Section Modulus In. <sup>3</sup>	Radius Gyration <sup>4</sup> In.
	a	b	c											
5 5.5630	-	-	5S	0.109	5.345	22.438	1.868	146	1.399	6.35	9.728	6.94713	2.498	1.929
	-	-	10S	0.134	5.295	22.02	2.285	146	1.386	7.77	9.547	8.42536	3.029	1.92
	40	Std	40s	0.258	5.047	20.006	4.3	1.46	1.321	14.6	8.673	15.1622	5.451	1.878
	80	XS	80s	0.375	4.813	18.194	6.112	146	1.26	20.8	7.888	206707	7.431	1.839
	120	-	-	0.500	4.563	16.353	7.953	146	1.195	27.0	7.09	25.7317	9.251	1.799
	160	-	-	0.625	4.313	14.61	9.696	146	1.129	33.0	6.334	300259	10.79	1.76
	-	XXS	-	0.750	4.063	12.965	11.34	146	1.064	38.6	5.621	33.6348	12.09	1.722
	-	-	-	0.875	3.813	11.419	12.887	1.46	0.9982	43.8	4.951	36.6355	13.17	1.686
	-	-	-	1.000	3.563	9.971	14.335	146	0.9328	48.7	4.323	39.1007	14.06	1.652
	-	-	-	1.125	3.313	8.126	16.178	1.46	0.8782	53.6	3.716	41.8311	15.01	1.618
6 6.6250	-	-	5S	0.109	6.407	32.24	2.231	1.73	1.677	7.59	13.98	11.8454	3.576	2.304
	-	-	10S	0.134	6.357	31.739	2.733	1.73	1.664	9.29	13.76	14.3974	4.346	2.295
	-	-	-	0.129	6.367	31.839	2.633	1.73	1.667	8.95	13.8	13.8918	4.194	2.297
	40	Std	40S	0.28	6.065	28.89	5.581	1.73	1.588	19.0	12.53	28.1422	8.496	2.245
	80	XS	80S	0.432	5.761	26.067	8.405	1.73	1.508	28.6	11.3	404907	12.22	2.195
	120	-	-	0.562	5.501	23.767	10.705	1.73	1.44	36.4	10.3	49.6106	14.98	2.153
	160	-	-	0.718	5.189	21.147	13.324	1.73	1.358	45.3	9.168	58.9732	17.8	2.104
	-	XXS	-	0.864	4.897	18.834	15.637	1.73	1.282	53.2	8.165	66.3326	20.02	2.06
	-	-	-	1.000	4.625	16.8	17.671	1.73	1.211	60.1	7.284	72.1009	21.77	2.02
	-	-	-	1.125	4.375	15.033	19.439	1.73	1.145	66.1	6.517	76.5775	23.12	1.985
8 8.6250	-	-	5S	0.109	8.407	55.51	2.916	2.26	2.201	9.91	24.07	26.4402	6.131	3.011
	-	-	10S	0.148	8.329	54.485	3.941	2.26	2.181	13.4	23.62	35.4145	8.212	2.998
	-	-	-	0.219	8.187	52.643	5.783	2.26	2.143	19.7	22.82	51.1172	11.85	2.973
	20	-	-	0.25	8.125	51.849	6.578	2.26	2.127	22.4	22.48	57.722	13.38	2.962
	30	-	-	0.277	8.071	51.162	7.265	2.26	2.113	24.7	22.18	63.3527	14.69	2.953
	40	Std	40S	0.322	7.981	50.027	8.399	2.26	2.089	28.6	21.69	72.4892	16.81	2.938
	60	-	-	0.406	7.813	47.943	10.483	2.26	2.045	35.6	20.79	88.7363	20.58	2.909
	80	XS	80S	0.500	7.625	45.664	12.763	2.26	1.996	43.4	19.8	105.716	24.51	2.878
	100	-	-	0.593	7.439	43.463	14.963	2.26	1.948	50.9	18.84	121.324	28.13	2.847
	120	-	-	0.718	7.189	40.591	17.836	2.26	1.882	60.6	17.6	140.535	32.59	2.807
10 10.7500	140	-	-	0.812	7.001	38.496	19.931	2.26	1.833	67.8	16.69	153.722	35.65	2.777
	160	-	-	0.906	6.813	36.456	21.97	2.26	1.784	74.7	15.8	165.887	38.47	2.748
	-	-	-	1.000	6.625	34.472	23.955	2.26	1.734	81.4	14.94	177.087	41.06	2.719
	-	-	-	1.125	6.375	31.919	26.507	2.26	1.669	90.1	13.84	190.572	44.19	2.681
	-	-	5S	0.134	10.482	86.294	4.469	2.81	2.744	15.2	37.41	62.9675	11.71	3.75
	-	-	10S	0.165	10.42	85.276	5.487	2.81	2.728	18.7	36.97	76.8638	14.3	3.74
	-	-	-	0.219	10.312	83.517	7.245	2.81	2.7	24.6	36.21	100.485	18.69	3.72
	20	-	-	0.250	10.25	82.516	8.247	2.81	2.683	28.0	35.77	113.714	21.16	3.71
	30	-	-	0.307	10.136	80.691	10.072	2.81	2.654	34.2	34.98	137.42	25.57	3.69
	40	Std	40S	0.365	10.02	78.854	11.908	2.81	2.623	40.5	34.19	160.734	29.9	3.67
60	XS	80S	0.500	9.75	74.662	16.101	2.81	2.553	54.7	32.37	211.95	39.43	3.63	
80	-	-	0.593	9.564	71.84	18.922	2.81	2.504	64.3	31.15	244.844	45.55	3.6	
100	-	-	0.718	9.314	68.134	22.629	2.81	2.438	76.9	29.54	286.132	53.23	3.56	
120	-	-	0.843	9.064	64.525	26.237	2.81	2.373	89.2	27.97	324.225	60.32	3.52	
-	-	-	0.875	9.000	63.617	27.145	2.81	2.356	92.3	27.58	333.485	62.04	3.51	
140	-	-	1.000	8.750	60.132	30.631	2.81	2.291	104	26.07	367.806	68.43	3.47	
160	-	-	1.125	8.500	56.745	34.018	2.81	2.225	116	24.6	399.308	74.29	3.43	
-	-	-	1.250	8.250	53.456	37.306	2.81	2.16	127	23.18	428.149	79.66	3.39	
-	-	-	1.500	7.750	47.173	43.59	2.81	2.029	148	20.45	478.464	89.02	3.31	



asc-es.com

Building connections that last™

## Properties of Pipe

Nom. Pipe Size, O.D. Inches	Number Schedule			Wall Thickness Inch	Inside Diameter Inch	Inside Area Sq. In.	Metal Area Sq. In.	Outside Surface Sq. Ft./ Ft.	Inside Surface Sq. Ft./ Ft.	Weight per Foot Lbs. †	Weight of Water per Foot Lbs.	Moment of Inertia In. <sup>4</sup>	Section Modulus In. <sup>3</sup>	Radius Gyration <sup>4</sup> In.
	a	b	c											
12 12.7500	-	-	5S	0.156	12.438	121.504	6.172	3.34	3.256	21	52.68	122.389	19.2	4.45
	-	-	10S	0.180	12.39	120.568	7.108	3.34	3.244	24.2	52.27	140.419	22.03	4.44
	20	-	-	0.250	12.25	117.859	9.817	3.34	3.207	33.4	51.1	191.824	30.09	4.42
	30	-	-	0.330	12.09	114.8	12.876	3.34	3.165	43.8	49.77	248.453	38.97	4.39
	-	Std	40S	0.375	12	113.097	14.579	3.34	3.142	49.6	49.03	279.335	43.82	4.38
	40	-	-	0.406	11.938	111.932	15.745	3.34	3.125	53.5	48.53	300.209	47.09	4.37
	-	XS	80S	0.5	11.75	108.434	19.242	3.34	3.076	65.4	47.01	361.544	56.71	4.33
	60	-	-	0.562	11.626	106.157	21.519	3.34	3.044	73.2	46.02	400.42	62.81	4.31
	80	-	-	0.687	11.376	101.641	26.035	3.34	2.978	88.5	44.07	475.104	74.53	4.27
	-	-	-	0.75	11.25	99.402	28.274	3.34	2.945	96.1	43.09	510.926	80.15	4.25
	100	-	-	0.843	11.064	96.142	31.534	3.34	2.897	107	41.68	561.65	88.1	4.22
	-	-	-	0.875	11	95.033	32.643	3.34	2.88	111	41.2	578.523	90.75	4.21
	120	-	-	1.000	10.75	90.763	36.914	3.34	2.814	125	39.35	641.664	100.7	4.17
	140	-	-	1.125	10.5	86.59	41.086	3.34	2.749	140	37.54	700.551	109.9	4.13
	-	-	-	1.250	10.25	82.516	45.16	3.34	2.683	154	35.77	755.378	118.5	4.09
	160	-	-	1.312	10.126	80.531	47.145	3.34	2.651	160	34.91	781.126	122.5	4.07
14 14.0000	-	-	5S	0.156	13.688	147.153	6.785	3.67	3.584	23.1	63.8	162.564	23.22	4.89
	-	-	10S	0.188	13.624	145.78	8.158	3.67	3.567	27.7	63.2	194.566	27.8	4.88
	-	-	-	0.210	13.58	144.84	9.098	3.67	3.555	30.9	62.79	216.308	30.9	4.88
	-	-	-	0.219	13.562	144.457	9.481	3.67	3.551	32.2	62.63	225.142	32.16	4.87
	10	-	-	0.250	13.5	143.139	10.799	3.67	3.534	36.7	62.06	255.3	36.47	4.86
	-	-	-	0.281	13.438	141.827	12.111	3.67	3.518	41.2	61.49	285.047	40.72	4.85
	20	-	-	0.312	13.376	140.521	13.417	3.67	3.502	45.6	60.92	314.384	44.91	4.84
	-	-	-	0.344	13.312	139.18	14.758	3.67	3.485	50.2	60.34	344.242	49.18	4.83
	30	Std	-	0.375	13.25	137.886	16.052	3.67	3.469	54.6	59.78	372.76	53.25	4.82
	40	-	-	0.437	13.126	135.318	18.62	3.67	3.436	63.3	58.67	428.607	61.23	4.8
	-	-	-	0.469	13.062	134.001	19.937	3.67	3.42	67.8	58.09	456.819	65.26	4.79
	-	XS	-	0.500	13	132.732	21.206	3.67	3.403	72.1	57.54	483.756	69.11	4.78
	60	-	-	0.593	12.814	128.961	24.977	3.67	3.355	84.9	55.91	562.287	80.33	4.74
	-	-	-	0.625	12.75	127.676	26.262	3.67	3.338	89.3	55.35	588.53	84.08	4.73
	80	-	-	0.750	12.5	122.718	31.22	3.67	3.272	106	53.2	687.318	98.19	4.69
	100	-	-	0.937	12.126	115.485	38.453	3.67	3.175	131	50.07	824.436	117.8	4.63
120	-	-	1.093	11.814	109.618	44.32	3.67	3.093	151	47.52	929.521	132.8	4.58	
140	-	-	1.250	11.5	103.869	50.069	3.67	3.011	170	45.03	1027.2	146.7	4.53	
160	-	-	1.406	11.188	98.309	55.629	3.67	2.929	189	42.62	1116.65	159.5	4.48	
16 16.0000	-	-	5S	0.165	15.67	192.854	8.208	4.19	4.102	27.9	83.61	257.303	32.16	5.6
	-	-	10S	0.188	15.624	191.723	9.339	4.19	4.09	31.7	83.12	291.904	36.49	5.59
	10	-	-	0.250	15.5	188.692	12.37	4.19	4.058	42.1	81.81	383.664	47.96	5.57
	20	-	-	0.312	15.376	185.685	15.377	4.19	4.025	52.3	80.5	473.248	59.16	5.55
	30	Std	-	0.375	15.25	182.654	18.408	4.19	3.992	62.6	79.19	562.084	70.26	5.53
	40	-	-	0.500	15	176.715	24.347	4.19	3.927	82.8	76.61	731.942	91.49	5.48
	60	-	-	0.656	14.688	169.44	31.622	4.19	3.845	108	73.46	932.336	116.5	5.43
	80	-	-	0.843	14.314	160.921	40.141	4.19	3.747	136	69.77	1156.29	144.5	5.37
	100	-	-	1.031	13.938	152.578	48.484	4.19	3.649	165	66.15	1364.43	170.6	5.3
	120	-	-	1.218	13.564	144.499	56.563	4.19	3.551	192	62.65	1555.41	194.4	5.24
	140	-	-	1.437	13.126	135.318	65.744	4.19	3.436	224	58.67	1759.86	220	5.17
	160	-	-	1.593	12.814	128.961	72.101	4.19	3.355	245	55.91	1893.54	236.7	5.12



## Properties of Pipe

Nom. Pipe Size, O.D. Inches	Number Schedule			Wall Thickness Inch	Inside Diameter Inch	Inside Area Sq. In.	Metal Area Sq. In.	Outside Surface Sq. Ft./ Ft.	Inside Surface Sq. Ft./ Ft.	Weight per Foot Lbs. †	Weight of Water per Foot Lbs.	Moment of Inertia In. <sup>4</sup>	Section Modulus In. <sup>3</sup>	Radius Gyration <sup>4</sup> In.
	a	b	c											
18 18.0000	-	-	5S	0.165	17.67	245.224	9.245	4.71	4.626	31.4	106.3	367.621	40.85	6.31
	-	-	10S	0.188	17.624	243.949	10.52	4.71	4.614	35.8	105.8	417.258	46.36	6.3
	-	-	-	0.250	17.5	240.528	13.941	4.71	4.581	47.4	104.3	549.138	61.02	6.28
	20	-	-	0.312	17.376	237.132	17.337	4.71	4.549	58.9	102.8	678.244	75.36	6.25
	-	Std	-	0.375	17.25	233.705	20.764	4.71	4.516	70.6	101.3	806.631	89.63	6.23
	30	-	-	0.437	17.126	230.357	24.112	4.71	4.484	82	99.87	930.264	103.4	6.21
	-	XS	-	0.500	17.0	226.98	27.489	4.71	4.451	93.5	98.4	1053.17	117	6.19
	40	-	-	0.562	16.876	223.681	30.788	4.71	4.418	105	96.97	1171.49	130.2	6.17
	60	-	-	0.750	16.5	213.825	40.644	4.71	4.32	138	92.7	1514.64	168.3	6.1
	80	-	-	0.937	16.126	204.241	50.228	4.71	4.222	171	88.55	1833.47	203.7	6.04
	100	-	-	1.156	15.688	193.297	61.172	4.71	4.107	208	83.8	2179.69	242.2	5.97
	120	-	-	1.375	15.25	182.654	71.815	4.71	3.992	244	79.19	2498.09	277.6	5.9
	140	-	-	1.562	14.876	173.805	80.664	4.71	3.895	274	75.35	2749.11	305.5	5.84
	160	-	-	1.781	14.438	163.721	90.748	4.71	3.78	309	70.98	3019.96	335.6	5.77
	-	-	5S	0.188	19.624	302.458	11.701	5.24	5.138	39.8	131.1	574.172	57.42	7
	-	-	10S	0.218	19.564	300.611	13.548	5.24	5.122	46.1	130.3	662.796	66.28	6.99
10	-	-	0.250	19.5	298.648	15.512	5.24	5.105	52.7	129.5	756.434	75.64	6.98	
20	Std	-	0.375	19.25	291.039	23.12	5.24	5.04	78.6	126.2	1113.47	111.3	6.94	
30	XS	-	0.500	19.0	283.529	30.631	5.24	4.974	104	122.9	1456.86	145.7	6.9	
40	-	-	0.593	18.814	278.005	36.155	5.24	4.925	123	120.5	1703.71	170.4	6.86	
60	-	-	0.812	18.376	265.211	48.948	5.24	4.811	166	115	2256.74	225.7	6.79	
-	-	-	0.875	18.25	261.587	52.573	5.24	4.778	179	113.4	2408.69	240.9	6.77	
80	-	-	1.031	17.938	252.719	61.440	5.24	4.696	209	109.6	2771.62	277.2	6.72	
100	-	-	1.281	17.438	238.827	75.332	5.24	4.565	256	103.5	3315.02	331.5	6.63	
120	-	-	1.500	17.0	226.98	87.179	5.24	4.451	296	98.4	3754.15	375.4	6.56	
140	-	-	1.750	16.5	213.825	100.335	5.24	4.32	341	92.7	4215.62	421.6	6.48	
160	-	-	1.968	16.064	202.674	111.486	5.24	4.206	379	87.87	4585.21	458.5	6.41	
-	-	SS	0.188	21.624	367.25	12.883	5.76	5.661	43.8	159.2	766.19	69.65	7.71	
-	-	10S	0.218	21.564	365.215	14.918	5.76	5.645	50.7	158.3	884.816	80.44	7.7	
10	-	-	0.250	21.500	363.05	17.082	5.76	5.629	58.1	157.4	1010.26	91.84	7.69	
20	Std	-	0.375	21.250	354.656	25.476	5.76	5.563	86.6	153.8	1489.67	135.4	7.65	
30	XS	-	0.500	21.000	346.361	33.772	5.76	5.498	115	150.2	1952.45	177.5	7.6	
-	-	-	0.625	20.75	338.163	41.970	5.76	5.432	143	146.6	2399	218.1	7.56	
60	-	-	0.750	20.5	330.064	50.069	5.76	5.367	170	143.1	2829.69	257.2	7.52	
80	-	-	0.875	20.25	322.062	58.07	5.76	5.301	197	139.6	3244.91	295	7.48	
100	-	-	1.125	19.75	306.354	73.778	5.76	5.171	251	132.8	4030.43	366.4	7.39	
120	-	-	1.375	19.25	291.039	89.094	5.76	5.04	303	126.2	4758.5	432.6	7.31	
140	-	-	1.625	18.75	276.117	104.016	5.76	4.909	354	119.7	5432	493.8	7.23	
160	-	-	1.875	18.25	261.587	118.546	5.76	4.778	403	113.4	6053.72	550.3	7.15	
160	-	-	2.125	17.75	247.45	132.683	5.76	4.647	451	107.3	6626.39	602.4	7.07	



asc-es.com

Building connections that last™

## Properties of Pipe

Nom. Pipe Size, O.D. Inches	Number Schedule			Wall Thickness Inch	Inside Diameter Inch	Inside Area Sq. In.	Metal Area Sq. In.	Outside Surface Sq. Ft./ Ft.	Inside Surface Sq. Ft./ Ft.	Weight per Foot Lbs. †	Weight of Water per Foot Lbs.	Moment of Inertia In. <sup>4</sup>	Section Modulus In. <sup>3</sup>	Radius Gyration <sup>4</sup> In.
	a	b	c											
24 24.0000	10	-	-	0.250	23.5	433.736	18.653	6.28	6.152	63.4	188	1315.34	109.6	8.4
	20	Std	-	0.375	23.25	424.557	27.833	6.28	6.087	94.6	184.1	1942.3	161.9	8.35
	-	XS	-	0.500	23	415.476	36.914	6.28	6.021	125	180.1	2549.35	212.4	8.31
	30	-	-	0.562	22.876	411.008	41.382	6.28	5.989	141	178.2	2843.2	236.9	8.29
	-	-	-	0.625	22.75	406.493	45.897	6.28	5.956	156	176.2	3136.93	261.4	8.27
	40	-	-	0.687	22.626	402.073	50.316	6.28	5.923	171	174.3	3421.28	285.1	8.25
	-	-	-	0.750	22.5	397.608	54.782	6.28	5.89	186	172.4	3705.46	308.8	8.22
	-	-	5S	0.218	23.564	436.102	16.288	6.28	6.169	55.4	189.1	1151.59	95.97	8.41
	-	-	-	0.875	22.25	388.821	63.568	6.28	5.825	216	168.6	4255.34	354.6	8.18
	60	-	-	0.968	22.064	382.348	70.042	6.28	5.776	238	165.8	4652.61	387.7	8.15
	80	-	-	1.218	21.564	365.215	87.174	6.28	5.645	296	158.3	5671.82	472.7	8.07
	100	-	-	1.531	20.938	344.318	108.071	6.28	5.482	367	149.3	6851.69	571	7.96
	120	-	-	1.812	20.376	326.083	126.307	6.28	5.334	429	141.4	7824.55	652	7.87
	140	-	-	2.062	19.876	310.276	142.114	6.28	5.204	483	134.5	8625.01	718.8	7.79
	160	-	-	2.343	19.314	292.978	159.412	6.28	5.056	542	127	9455.42	788	7.7
	-	-	-	0.250	25.5	510.705	20.224	6.81	6.676	68.8	221.4	1676.38	129	9.1
26 26.0000	10	-	-	0.312	25.376	505.75	25.179	6.81	6.643	85.6	219.3	2077.16	159.8	9.08
	-	Std	-	0.375	25.25	500.74	30.189	6.81	6.61	103	217.1	2478.42	190.6	9.06
	20	XS	-	0.500	25	490.874	40.055	6.81	6.545	136	212.8	3257	250.5	9.02
	-	-	-	0.625	24.75	481.105	49.824	6.81	6.48	169	208.6	4012.56	308.7	8.97
	-	-	-	0.75	24.5	471.435	59.494	6.81	6.414	202	204.4	4745.57	365	8.93
	-	-	-	0.875	24.25	461.863	69.066	6.81	6.349	235	200.2	5456.48	419.7	8.89
	-	-	-	1.000	24	452.389	78.54	6.81	6.283	267	196.1	6145.74	472.7	8.85
	-	-	-	1.125	23.75	443.014	87.916	6.81	6.218	299	192.1	6813.8	524.1	8.8
	-	-	-	0.25	27.5	593.957	21.795	7.33	7.199	74.1	257.5	2098.09	149.9	9.81
	10	Std	-	0.312	27.376	588.613	27.139	7.33	7.167	92.3	255.2	2601.02	185.8	9.79
-	XS	-	0.375	27.25	583.207	32.545	7.33	7.134	111	252.8	3105.12	221.8	9.77	
28 28.0000	20	-	-	0.500	27.000	572.555	43.197	7.33	7.069	147	248.2	4084.81	291.8	9.72
	30	-	-	0.625	26.75	562.001	53.751	7.33	7.003	183	243.6	5037.66	359.8	9.68
	-	-	-	0.750	26.5	551.546	64.206	7.33	6.938	218	239.1	5964.16	426	9.64
	-	-	-	0.875	26.25	541.188	74.564	7.33	6.872	253	234.6	6864.82	490.3	9.6
	-	-	-	1.000	26	530.929	84.823	7.33	6.807	288	230.2	7740.1	552.9	9.55
	-	-	-	1.125	25.75	520.768	94.984	7.33	6.741	323	225.8	8590.49	613.6	9.51
	-	-	5S	0.250	29.5	683.493	23.366	7.85	7.723	79.4	296.3	2585.18	172.3	10.52
	10	-	10S	0.312	29.376	677.759	29.099	7.85	7.691	98.9	293.8	3206.31	213.8	10.5
	-	Std	-	0.375	29.25	671.957	34.901	7.85	7.658	119	291.3	3829.44	255.3	10.47
	20	XS	-	0.500	29	660.52	46.338	7.85	7.592	158	286.4	5042.21	336.1	10.43
30 30.0000	30	-	-	0.625	28.75	649.181	57.678	7.85	7.527	196	281.4	6224.01	414.9	10.39
	40	-	-	0.750	28.5	637.94	68.919	7.85	7.461	234	276.6	7375.38	491.7	10.34
	-	-	-	0.875	28.25	626.797	80.062	7.85	7.396	272	271.7	8496.84	566.5	10.3
	-	-	-	1.000	28	615.752	91.106	7.85	7.33	310	267	9588.93	639.3	10.26
	-	-	-	1.125	27.75	604.806	102.053	7.85	7.265	347	262.2	10652.1	710.1	10.22
	-	-	-	0.250	29.5	683.493	23.366	7.85	7.723	79.4	296.3	2585.18	172.3	10.52
	10	-	-	0.312	31.376	773.188	31.06	8.38	8.214	106	335.2	3898.89	243.7	11.2
	-	-	-	0.375	31.25	766.99	37.257	8.38	8.181	127	332.5	4658.48	291.2	11.18
	20	Std	-	0.500	31	754.768	49.48	8.38	8.116	168	327.2	6138.62	383.7	11.14
	30	XS	-	0.625	30.75	742.643	61.605	8.38	8.05	209	322	7583.39	474	11.09
32 32.0000	40	-	-	0.688	30.624	736.569	67.678	8.38	8.017	230	319.3	8298.32	518.6	11.07
	-	-	-	0.750	30.5	730.617	73.631	8.38	7.985	250	316.8	8993.35	562.1	11.05
	-	-	-	0.875	30.25	718.688	85.559	8.38	7.919	291	311.6	10369.1	648.1	11.01
	-	-	-	1.000	30	706.858	97.389	8.38	7.854	331	306.5	11711.1	731.9	10.97
	-	-	-	1.125	29.75	695.126	109.121	8.38	7.789	371	301.4	13020	813.7	10.92

## Properties of Pipe

Nom. Pipe Size, O.D. Inches	Number Schedule			Wall Thickness Inch	Inside Diameter Inch	Inside Area Sq. In.	Metal Area Sq. In.	Outside Surface Sq. Ft./ Ft.	Inside Surface Sq. Ft./ Ft.	Weight per Foot Lbs. †	Weight of Water per Foot Lbs.	Moment of Inertia In. <sup>4</sup>	Section Modulus In. <sup>3</sup>	Radius Gyration <sup>4</sup> In.	
	a	b	c												
34 34.0000	-	-	-	0.250	33.500	881.413	26.507	8.90	8.770	90.1	382.1	3774.38	222.0	11.93	
	10	-	-	0.312	33.376	874.9	33.02	8.90	8.738	112	379.3	4684.65	275.6	11.91	
	-	Std	-	0.375	33.250	868.307	39.614	8.90	8.705	135	376.4	5599.28	329.4	11.89	
	20	XS	-	0.500	33.000	855.288	52.632	8.90	8.639	179	370.8	7384.89	434.4	11.85	
	30	-	-	0.625	32.750	842.389	65.532	8.90	8.574	223	365.2	9127.59	536.9	11.8	
	40	-	-	0.688	32.624	835.919	72.001	8.90	8.541	245	362.4	995.61	587.7	11.78	
	-	-	-	0.750	32.500	829.577	78.343	8.90	8.508	266	359.7	10832.2	637.2	11.76	
	-	-	-	0.875	32.250	816.863	91.057	8.90	8.443	310	354.1	12497.9	735.2	11.72	
	-	-	-	1.000	32.000	804.248	103.673	8.90	8.378	352	348.7	14125.4	830.9	11.67	
	-	-	-	1.125	31.750	791.73	116.190	8.90	8.312	395	343.2	15715.1	924.4	11.63	
	36 36.0000	-	-	-	0.250	35.500	989.798	28.078	9.42	9.294	95.5	429.1	4485.9	249.2	12.64
		10	-	-	0.312	35.376	982.895	34.981	9.42	9.261	119	426.1	5569.48	309.4	12.62
-		Std	-	0.375	35.250	975.906	41.970	9.42	9.228	143	423.1	6658.92	369.9	12.6	
20		XS	-	0.500	35.000	962.113	55.763	9.42	9.163	190	417.1	8786.2	488.1	12.55	
30		-	-	0.625	34.750	948.417	69.459	9.42	9.098	236	411.2	10868.4	603.8	12.51	
40		-	-	0.75	34.500	934.82	83.056	9.42	9.032	282	405.3	12906.1	717.0	12.47	
-		-	-	0.875	34.250	921.321	96.555	9.42	8.967	328	399.4	14900.0	827.8	12.42	
-		-	-	1.000	34.000	907.92	109.956	9.42	8.901	374	393.6	16850.7	936.2	12.38	
-		-	-	1.125	33.750	894.618	123.258	9.42	8.836	419	387.9	18758.9	1042.2	12.34	
-		-	-	0.25	41.500	1352.652	32.790	11.00	10.86	111	586.4	71447.1	340.2	14.76	
-		Std	-	0.375	41.250	1336.404	49.038	11.00	10.80	167	579.4	10621.6	505.8	14.72	
42 42.0000		20	XS	-	0.500	41.000	1320.254	65.188	11.00	10.73	222	572.4	14035.8	668.4	14.67
	30	-	-	0.625	40.750	1304.203	81.24	11.00	10.67	276	565.4	17388.1	828.0	14.63	
	40	-	-	0.75	40.500	1288.249	97.193	11.00	10.6	330	558.5	20679.3	984.7	14.59	
	-	-	-	1.000	40.000	1256.637	128.805	11.00	10.47	438	544.8	27081.3	1289.6	14.5	
	-	-	-	1.250	39.500	1225.417	160.025	11.00	10.34	544	531.3	33247.7	1583.2	14.41	
	-	-	-	1.500	39.000	1194.591	190.852	11.00	10.21	649	517.9	39184.3	1865.9	14.33	



asc-es.com

Building connections that last™



### **About ASC Engineered Solutions**

ASC Engineered Solutions is defined by quality—in its products, services and support. With nearly 2,000 employees, the company’s portfolio of precision-engineered piping support, valves and connections provides products to more than 4,000 customers across industries, such as mechanical, industrial, fire protection, oil and gas, and commercial and residential construction. Its portfolio of leading brands includes ABZ Valve®, AFCON®, Anvil®, Anvil EPS, Anvil Services, Basic-PSA, Beck®, Catawissa, Cooplet®, FlexHead®, FPPI®, Gruvlok®, J.B. Smith, Merit®, North Alabama Pipe, Quadrant®, SCI®, Sharpe®, SlideLOK®, SPF®, SprinkFLEX®, Trenton Pipe and VEP. With headquarters in Oak Brook, IL, ASC also has ISO 9001:2015 certified production facilities in PA, TN, IL, TX, AL, LA, KS, and RI.



[asc-es.com](http://asc-es.com)

Building connections that last™

