

Value Engineered Products

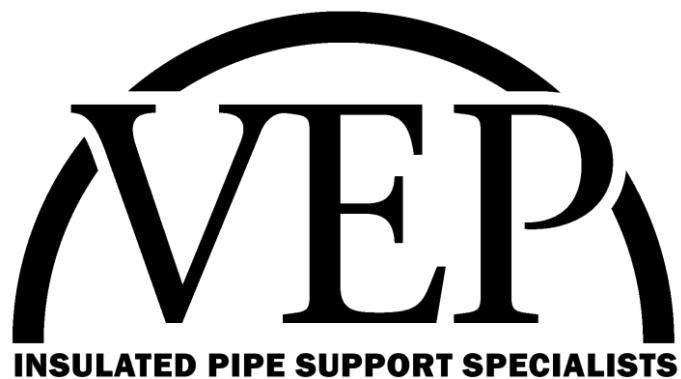

VEP Continuously Strives For Excellence In Our People, Product, Process And Service

756 S Jason Street, Suite 17 Denver, Colorado 80223

303-715-9990 sales@valueng.com

www.valueng.com

TABLE OF CONTENTS

PROUDLY SOURCED AND MANUFACTURED IN THE U.S.A.

| | |
|--|----|
| Value Engineered Products | |
| Introduction | 2 |
| Product Introduction..... | 3 |
| Pro-Shield | 4 |
| Chill-Shield..... | 5 |
| Quik-Shield | 6 |
| MaxSpan | 7 |
| MaxSpan R.H. | 8 |
| PP-R Pro-Shield | 9 |
| Seismic Shield™ | 10 |
| Seismic Shield™ Ordering Guide..... | 11 |
| PG Series Insulated Pipe Guides | 12 |
| PS Series Insulated Pipe Slides..... | 13 |
| PA Series Insulated Pipe Anchors..... | 14 |
| Insulated Guide and Slide Selection Chart..... | 15 |
| Weather Shield Upgrade..... | 16 |
| Duct Trapeze Corner Supports | 17 |
| Application Information | 18 |
| Hanger Sizing Guide | 19 |
| Pipe Dimensions / MSS Allowable Spans ... | 20 |
| Suggested Specification Guidelines for Insulated Pipe Supports | 21 |
| Manufacturers Standardization Society (MSS) Statement..... | 22 |
| General Terms and Conditions of Sale, Warranty | 23 |

Revised March 2022

Submittal Pages are available on request
VEP's most current information is always available on our website
www.valueng.com

Introduction

Excellence By Design

Value Engineered Products (VEP) offers the engineering, mechanical, plumbing and insulation communities a series of insulated pipe supports designed to meet the broadest range of applications. Our product line is extremely easy to specify and install and meets or exceeds all industry standards. In addition to offering excellent products, VEP is continually updating and improving our designs and product offerings. This is one of the reasons we have been a trusted industry leader and innovator for over three decades.

Setting The Standard

All insulated pipe systems require protection at each point of support to maintain the integrity of the insulation system. Descriptions for this type of product vary widely throughout the industry. The most commonly referenced standards are those published by the Manufacturers Standardization Society of the Pipe, Valve and Fitting Industry (MSS)*.

The MSS document SP-58, Paragraph 7.6 "Protection Saddles and Shields" provides the parameters for Type 40 thermal hanger shields. These standards generically call for 'high-density inserts.' Value Engineered Products has helped to better define 'high-density' in terms of compressive strength, and therefore, offer materials with documented compressive strengths up to 3000 PSI.

In addition to products that meet or exceed the minimum protection requirements, VEP has designed products that take into account practical matters that occur in the field, such as point loading, moisture resistance, unit weight and overall ease of installation.

Value Engineered Products' Pro-Shield, and MaxSpan R.H. meet the design criteria of both the Manufacturers Standardization Society and the American Institute of Architects 'MasterSpec' provisions.

Simplicity Of Design

Our insulated pipe supports are easy to specify, order and install. Each design works seamlessly together with the standard pipe hanger system to provide the level of protection needed. VEP offers a simple, one-piece hinged construction for high-density insulation for hot or cold pipe systems. Our products have a factory applied jacketing meeting ASTM E 96A (maximum 0.02 perm) and galvanized steel shield in one, easy-to-install, pre-assembled unit that will always meet code specifications.

VEP continually delivers products offering excellent performance with a proven track record in design and supply chain management.

*All MSS references and quotes in this catalogue are extracted from MSS SP-58 (2009) with permission of the publisher, The Manufacturers Standardization Society.

Product Introduction

Value Engineered Products manufactures a wide array of insulated pipe supports to meet the needs of various piping systems and specifications. Units may be ordered to precisely fit copper tube, steel or cast at no additional cost. Custom sized units for ductile Iron and plastic pipes are available also. Standard units are available in 1/2" wall thickness through 6" pipe and 1" wall thickness through 24" pipe diameters. Ultra-high compressive strength structural inserts are standard on 10" pipe with 1" wall thickness and all units for 12" pipe size and larger. Pro-Shield and Quik-Shield units 20" pipe and larger will be entirely of this material.

All products feature a factory applied jacketing meeting ASTM E 96A (maximum 0.02 perm) making the units appropriate for either high or low temperature applications. The jacketing and insulation extend beyond the steel shields to provide a positive, neat seal with the adjoining insulation jacket. Custom units can be manufactured to meet any engineering requirements.



MaxSpan RH

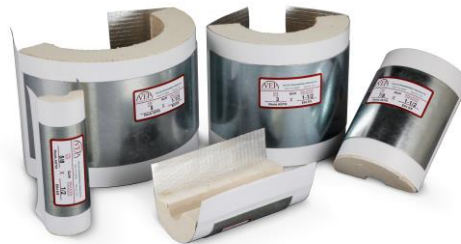

Quik-Shield



Chill-Shield



Pro-Shield



Seismic Shield™



Pro-Shield

Description / Features

Pro-Shields are 360° thermal hanger shields designed to meet the broadest range of pipe support applications. They provide a continuous section of insulation with factory applied jacketing meeting ASTM E 96A (maximum 0.02 perm) through a wide variety of pipe hangers for pipe systems operating between +20° F. and +1200° F. The insulation and jacketing extend beyond the galvanized steel shield for a neatly sealed joint with the adjoining insulation. Pro-Shields are suitable for use in any type of clamp as well as in band-type hangers and on flat surfaces. To assure proper support in all situations, high density 450 PSI inserts are installed in units for 10" pipe with 1" insulation thickness and in all units for 12" pipe and larger. **Pro-Shields meet the MSS standard for a Type 40 shield per MSS SP-58, Paragraph 7.63 – 7.66. Pro-Shields Meet ASTM E84 Standards Flame Spread-5-, smoke developed-5-. Rounded shield corners on all commercial size units.**

Applications

- For indoor use on clamping support systems, flat surfaces, clevis or other band-type hangers (see WeatherShield Upgrade submittal for outdoor use).
- Pipe sizes 16" and larger *in clevis or two bolt hangers only*.
- Chilled to steam piping and dual temperature lines.
- Hanger spans per MSS SP-58 Table A3.
- Available for pipe ½" through 24", Insulation thickness ½" through 6"

Materials / Construction

- 100 PSI Calcium silicate meeting ASTM C-533 Type 1, C-585, C-795, E-84, Thermal Conductivity ('k')=.40 @ 75° F.
- Adhesive complying with NFPA 90-A, ASTM E-84
- G-90 Galvanized steel shield, small check per ASTM A-653 (replaces A-527). **Rounded corners for safety.**
- Factory applied jacketing meeting ASTM E 96A (maximum 0.02 perm), ASTM D-774, D-828 and E-84,
- Structural insert (12" pipe and larger) minimum 450 PSI calcium silicate meeting ASTM C-656 Type II, Grade 5, C-795 and E-84. Units for 20" pipe and larger are 360° of this material.
- All units and components are asbestos free and 100% sourced and assembled in the U.S.A.

DIMENSIONS

| | 1/2" To 5" | 6" To 8" | 10" To 12" | 14" to 18" | 20" To 24" |
|-----------------------------|------------|----------|-----------------------------------|-----------------------------------|------------|
| Insulation Length | 6" | 9" | 9" | 12" | 9" |
| | 150 mm | 230 mm | 230 mm | 300 mm | 230 mm |
| Shield Length | 4" | 6" | 6" | 10" | 6" |
| | 100 mm | 150 mm | 150 mm | 250 mm | 150 mm |
| Shield Gauge | 22 ga. | 18 ga. | 18 ga. | 12 ga. | 18 ga. |
| | 0.9 mm | 1.3 mm | 1.3 mm | 2.8 mm | 1.3 mm |
| Compressive Strength | 100 PSI | 100 PSI | Cal Sil 100 PSI Insert 450 PSI | Cal Sil 100 PSI Insert 450 PSI | 450 PSI |

Chill-Shield



Description / Features

Chill-Shields are 360° thermal hanger shields designed to meet a broad range of pipe support applications on low temperature lines. They provide a continuous section of insulation and factory applied jacketing meeting ASTM E 96A (maximum 0.02 perm), and are designed for pipe systems operating between -250° F. and +225° F. The insulation and jacketing extend beyond the galvanized steel shield for a neat, joint with the adjoining insulation. Chill-Shields are suitable for use in any type of clamp as well as in band-type hangers. Polyisocyanurate inserts and heavy gauge steel shields ensure proper pipe support. These cost-effective designs meet the requirements of either pipe or tube systems. Chill-Shields are an ASTM fire rated system meeting 25/50 Flame /Smoke rating when tested with fiberglass pipe insulation.

Applications

- For indoor use on clamping support systems, clevis or other band-type hangers.
- Chilled piping to domestic hot water.
- Hanger spans per MSS SP-58 Table A3 (not suitable for extended hanger spans).
- Available for pipe ½” through 24”.

Materials / Construction

- 360° Polyisocyanurate 24 PSI material-Thermal Conductivity ('k') .19 @ 75°F for Tube sizes through 6” and pipe sizes (IPS) ½” through 2”, 40 PSI material-Thermal Conductivity ('k') .20 @ 75° F for pipe sizes larger than 2” and tube sizes larger than 6”.
- Meeting ASTM D-1621, D-1622, D-1623, C-203, C-518.
- 360° Non-reactive, factory applied jacketing meeting ASTM E 96A (maximum 0.02 perm), ASTM D-774, D-828.
- Adhesive complying with NFPA 90-A.
- G-90 Galvanized steel shield, small check per ASTM A-653 (replaces A-527). **Rounded corners for safety.**
- All units and components are asbestos free and 100% sourced and assembled in the U.S.A.

DIMENSIONS

| Pipe or Tube | Copper Tube 5/8” to 5-1/8” | IPS 1/2” to 2” | IPS 2-1/2” to 5” | Copper Tube 6-1/8” | IPS 6” and 8” | IPS 10” to 24” |
|----------------------|-------------------------------|-------------------|---------------------|-----------------------|------------------|------------------------------|
| Insulation Length | 6” 150 mm | 6” 150 mm | 6” 150 mm | 9” 230 mm | 9” 230 mm | Call Sales @ 303-715-9990 |
| Shield Length | 4” 100 mm | 4” 100 mm | 4” 100 mm | 6” 150 mm | 6” 150 mm | |
| Shield Gauge | 22 ga. 0.9 mm | 22 ga. 0.9 mm | 22 ga. 0.9 mm | 18 ga. 1.3 mm | 18 ga. 1.3 mm | |
| Compressive Strength | 24 PSI | 24 PSI | 40 PSI | 24 PSI | 40 PSI | |

Quik-Shield



Description / Features

Quik-Shields are economically priced 180° thermal hanger shields providing a continuous section of insulation and factory applied jacketing meeting ASTM E 96A (maximum 0.02 perm) through a variety of pipe hangers. The jacket extends beyond the galvanized steel shield and beyond the insulation insert for a neat, joint with both the adjoining and the field-applied top insulation. To assure proper support in all situations, high density 450 PSI structural inserts are installed on units for 10" pipe with 1" wall thickness and on all units for 12" pipe and larger. **Quik-Shields meet the ASTM E84 Standard Flame Spread -5-, Smoke Developed -5-. Rounded shield corners on all commercial size units.**

Applications

- For indoor use on flat surfaces, clevis or other band-type hangers.
- Pipe sizes 16" and larger in *clevis hangers only*.
- Chilled to steam piping and dual temperature lines.
- Hanger spans per MSS SP-58 Table A3.
- Available for pipe ½" through 24"
- Insulation thickness ½" through 6"

Materials / Construction

- 100 PSI Calcium silicate meeting ASTM C-533 Type 1, C-585, C-795, E-84, Thermal Conductivity ('k') .40 @ 75° F. mean.
- Adhesive complying with NFPA 90-A, ASTM E-84
- G-90 Galvanized steel shield, small check per ASTM A-653 (replaces A-527). **Rounded corners for safety.**
- Factory applied jacketing meeting ASTM E 96A (maximum 0.02 perm), ASTM D-774, D-828 and E-84.
- Structural insert (12" pipe and larger) 450 PSI calcium silicate meeting ASTM C-656 Type II, Grade 5, C-795 and E-84. Units for 20" pipe and larger are 180° of 450 PSI material.
- All units and components are asbestos free and 100% sourced and assembled in the U.S.A.

DIMENSIONS

| | 1/2" To 5" | 6" To 8" | 10" To 12" | 14" to 18" | 20" To 24" |
|-----------------------------|------------|----------|-----------------------------------|-----------------------------------|------------|
| Insulation Length | 6" | 9" | 9" | 12" | 9" |
| | 150 mm | 230 mm | 230 mm | 300 mm | 230 mm |
| Shield Length | 4" | 6" | 6" | 10" | 6" |
| | 100 mm | 150 mm | 150 mm | 250 mm | 150 mm |
| Shield Gauge | 22 ga. | 18 ga. | 18 ga. | 12 ga. | 18 ga. |
| | 0.9 mm | 1.3 mm | 1.3 mm | 2.8 mm | 1.3 mm |
| Compressive Strength | 100 PSI | 100 PSI | Cal Sil 100 PSI Insert 450 PSI | Cal Sil 100 PSI Insert 450 PSI | 450 PSI |

MaxSpan



Description / Features

MaxSpan thermal hanger shields are designed to provide a superior safety margin when supporting pipe with hanger spans up to the maximum allowed in Table 4 of the MSS SP-58 in clevis or clamp hangers. These 360° thermal hanger shields provide a continuous section of insulation and factory applied jacketing meeting ASTM E 96A (maximum 0.02 perm) through the hanger and can be used on piping systems operating between +20° F. and +1200° F. The insulation and jacketing extend beyond the galvanized steel shield for a neatly sealed joint with the adjoining insulation. To achieve the protection required by long hanger spans, MaxSpan thermal hanger shields utilize heavier gauge shields, and utilize Type 2 calcium silicate (Grade 5, 450 PSI for 10" through 14" and Grade 6, 900 PSI for 16" pipe and larger). The **MaxSpan meets or exceeds the MSS standard for Type 40 Shields per MSS SP-58, Paragraph 7.63 – 7.66. MaxSpan meets the ASTM E84 Standard Flame Spread -5-, Smoke Developed -5-. Rounded shield corners on all commercial size units.**

Applications

- For indoor use on all band and clamping hanger systems (see WeatherShield Upgrade data sheet for outdoor applications).
- Chilled to steam piping and dual temperature lines.
- Hanger spans per MSS SP-58 Table 4 in clevis or two-bolt clamp hangers.
- Available for pipe through 20". (Pipes 24" and larger will be custom quoted)
- Insulation thickness ½" through 6"

Materials / Construction

- ½" through 8" pipe - 360° 100 PSI Calcium silicate meeting ASTM C-533 Type 1, C-585, C-795, E-84, Thermal Conductivity ('k') .40 @ 75 °F mean.
- 10" through 18" pipe 100 PSI Top, 450 PSI Type 2 Grade 5 calcium silicate bottom.
- 20" pipe and larger 360° 900 PSI Type 2 Grade 6 calcium silicate.
- Adhesive complying to NFPA 90-A and ASTM E-84.
- G-90 Galvanized steel shield, small check per ASTM A-653 (replaces A-527). **Rounded corners for safety.**
- Factory applied jacketing meeting ASTM E 96A (maximum 0.02 perm), ASTM D-774, D-828 and E-84.
- All units and components are asbestos free and 100% sourced and assembled in the U.S.A.

DIMENSIONS

| | 1/2" To 3" | 4" To 5" | 6" to 8" | 10" to 18" | 20" to 24" |
|-----------------------------|------------|----------|----------|------------|------------|
| Insulation Length | 6" | 9" | 9" | 9" | 9" |
| | 150 mm | 230 mm | 230 mm | 230 mm | 230 mm |
| Shield Length | 4" | 6" | 6" | 6" | 6" |
| | 100 mm | 150 mm | 150 mm | 150 mm | 150 mm |
| Shield Gauge | 22 ga. | 18 ga. | 14 ga. | 14 ga. | 14 ga. |
| | 0.9 mm | 1.3 mm | 2.0 mm | 2.0 mm | 2.0 mm |
| Compressive Strength | 100 PSI | 100 PSI | 100 PSI | 450 PSI | 900 PSI |

MaxSpan R.H.



Description / Features

The MaxSpan R.H. thermal hanger shield is specifically designed to provide a superior safety margin for pipe mounted on pipe rollers, flat surfaces or with supports where point loading may be a concern. These rugged units allow hanger spans up to the maximum allowed in Table 4 of the MSS SP-58. They are appropriate for either hot or cold pipe systems. The insulation and factory applied jacketing meeting ASTM E 96A (maximum 0.02 perm) extend beyond the galvanized steel shield for a neatly sealed joint with the adjoining insulation. Units for pipe 4" and larger include a wear/weight distribution plate of carbon steel (primer painted). Additionally, a segment of ultra-high density, 900 PSI calcium silicate is fabricated into units for 10" pipe size and larger. The **MaxSpan R.H. meets or exceeds the MSS standard for Type 40 Shields per MSS SP-58, Paragraph 7.63 – 7.66. MaxSpan R.H. meets the ASTM E84 Standard Flame Spread -5-, Smoke Developed -5-. Rounded shield corners on all commercial size units.**

Applications

- For indoor use on all roller hanger systems and flat surfaces (see Weather Shield Upgrade data page for outdoor applications).
- Chilled to steam piping and dual temperature lines.
- Hanger spans per MSS SP-58 Table 4.
- Available for pipes ½" through 20". (Pipes 24" and larger will be custom quoted)
- Insulation thickness ½" through 6"

Materials / Construction

- 100 PSI Calcium silicate meeting ASTM C-533 Type 1, C-585, C-795, E-84, Thermal Conductivity ('k') .40 @ 75° F mean.
- Adhesive complying with NFPA 90-A and ASTM E-84.
- G-90 Galvanized steel shield, small check per ASTM A-653 (replaces A-527). **Rounded corners for safety.**
- Wear/Weight Distribution Plate - carbon steel meeting ASTM A-36.
- Factory applied jacketing meeting ASTM E 96A (maximum 0.02 perm), ASTM D-774, D-828 and E-84.
- Structural insert (10" pipe and larger) of 900 PSI calcium silicate per ASTM C-656 Type II Grade 6.

DIMENSIONS

| | 1/2" To 1-1/2" | 2" To 3" | 4" To 8" | 10" To 12" | 14" To 20" |
|-----------------------------|----------------|----------|-----------|-----------------------------------|-----------------------------------|
| Insulation Length | 9" | 9" | 9" | 12" | 12" |
| | 230 mm | 230 mm | 230 mm | 300 mm | 300 mm |
| Shield Length | 6" | 6" | 6" | 8" | 10" |
| | 150 mm | 150 mm | 150 mm | 200 mm | 250 mm |
| Shield Gauge | 18 ga. | 16 ga. | 18 ga. | 18 ga. | 18 ga. |
| | 1.3 mm | 1.6 mm | 1.3 mm | 1.3 mm | 1.3 mm |
| Plate Dimensions | N/A | N/A | 1/8" X 6" | 1/4" X 8" | 1/4" X 10" |
| Compressive Strength | 100 PSI | 100 PSI | 100 PSI | Cal Sil 100 PSI Insert 900 PSI | Cal Sil 100 PSI Insert 900 PSI |
| Travel Allowed | +/- 2" | +/- 2" | +/- 2" | +/- 2" | +/- 3" |

Customized for Metric sized PP-R pipe sizes



Description / Features

PP-R Pro-Shields are 360° thermal hanger shields custom cut for Perfect ID match to metric PP-R OD's. They are designed to meet a broad range of pipe support applications while providing a continuous section of insulation and factory applied jacketing meeting ASTM E 96A (maximum 0.02 perm) through a variety of pipe hangers. These units are appropriate across the entire PP-R temperature range. On all units the insulation and jacketing extend beyond the galvanized steel shield for neatly sealed joint with the adjoining insulation. Units are suitable for use in any type of clamp as well as in band-type hangers and on flat surfaces. **PP-R Pro-Shields meet the MSS standard for a Type 40 shield per MSS SP-58, Paragraph 7.63 – 7.66. PP-R Pro-Shields meet ASTM Standards Flame Spread-5-, Smoked Developed -5-.**

Applications

- For indoor use on clamping support systems, flat surfaces, clevis or other band-type hangers (see Weather Shield Upgrade submittal for outdoor use).
- Hanger spans per MSS SP-58 Table A3.
- Available for pipe 20mm through 450mm with insulation thicknesses 1", 1-1/2" and 2".

Materials / Construction

- Minimum 100 PSI Calcium silicate meeting ASTM C-533 Type 1, C-795, E-84, E-84, Thermal Conductivity ('k') .40 @ 75° F. mean.
- Adhesive complying with NFPA 90-A, ASTM E-84.
- G-90 Galvanized steel shield, small check per ASTM A-653 (replaces A-527). **Rounded corners for safety.**
- Factory applied jacketing meeting ASTM E 96A (maximum 0.02 perm), ASTM D-774, D-828 and E-84.
- All units and components are asbestos free and 100% sourced and assembled in the U.S.A.

DIMENSIONS

| | 20 mm To 50 mm | 63 mm To 125 mm | 160 mm | 200 mm To 450 mm |
|----------------------|-------------------|--------------------|---------|-------------------------------|
| Insulation Length | 6" | 6" | 9" | Call Sales @ 303- 715-9990 |
| | 150 mm | 150 mm | 230 mm | |
| Shield Length | 4" | 4" | 6" | |
| | 100 mm | 100 mm | 150 mm | |
| Shield Gauge | 22 ga. | 22 ga. | 18 ga. | |
| | 0.9 mm | 0.9 mm | 1.3 mm | |
| Compressive Strength | 100 PSI | 100 PSI | 100 PSI | |



Description/ Features

Seismic Shield (Patent Pending) is an innovative insulation protection shield offered by Value Engineered Products (VEP). This product is designed to stop shield movement and rotation while allowing for expansion and contraction of piping systems. Seismic Shield is designed to support the weight of the pipe and insulation. Each shield has Seismic Grip Tabs, which indicate a clear area to center the shield and may be bent down 90° to form a friction fit to strut or bent further to firmly grip a clevis hanger. Each shield has rounded corners for installer safety and vapor barrier protection.

Seismic Shield is offered in two grades
 Standard and MSS Compliant*

*Complies with MSS Type 40 - minimum requirements for small bore pipe

Applications

Seismic Shields in both Standard and MSS Compliant configurations are designed to be installed following the same guidelines as all VEP's Insulation Protection Shields. Specifications often allow shields without high density inserts on small-bore pipe. Steel shields alone may be permitted on larger diameter pipe, providing the length of the shield is sufficient to prevent the insulation from showing signs of compression from the weight of the pipe plus the weight of the media being transported along with any valves or fittings.

Materials/Construction

*100% American made steel

*G-90 Galvanized steel shield, small check per ASTM A-653 (replaces A-527)

*Precision pressed or rolled to ASTM C-585 dimensional standards

***Standard** Seismic Shield - 12" long, 22 gauge, ID 2.0 through 5.5 and 18 gauge ID 6.5 through 14.0 available in full bucket or box quantities.

* **MSS Compliant** Shield - 12" long, 18 gauge, ID 2.0 through 5.5 available in full bucket or box quantities

*Custom Seismic Shields are available per MSS SP-58 Table A3 dimensions (Older specifications may reference MSS SP-69, Table 5 dimensions) – Seismic Grip tabs are not available for 16 gauge or greater.

*Stainless Steel and Custom Shields are available. Call VEP for more information.

**Seismic Shield Sizing Guide
 Insulation OD per ASTM C-585**

| Iron Pipe | Insulation Wall Thickness | | | |
|-----------|---------------------------|------|--------|------|
| | X ½" | X 1" | X 1 ½" | X2" |
| ½ | 2.0 | 3.0 | 4.0 | 5.0 |
| ¾ | 2.5 | 3.0 | 4.0 | 5.0 |
| 1 | 2.5 | 3.5 | 4.5 | 5.5 |
| 1-1/4 | 3.0 | 3.5 | 5.0 | 5.5 |
| 1-1/2 | 3.0 | 4.0 | 5.0 | 6.5 |
| 2 | 3.5 | 4.5 | 5.5 | 6.5 |
| 2-1/2 | 4.0 | 5.0 | 6.5 | 7.5 |
| 3 | 4.5 | 5.5 | 6.5 | 7.5 |
| 4 | 5.5 | 6.5 | 7.5 | 8.5 |
| 5 | 6.5 | 7.5 | 8.5 | 9.5 |
| 6 | 7.5 | 8.5 | 9.5 | 11.0 |
| 8 | | 11.0 | 12.0 | 13.0 |
| 10 | | 13.0 | 14.0 | 15.0 |
| 12 | | 15.0 | 16.0 | 17.0 |
| 14 | | 16.0 | 17.0 | 18.0 |

| Copper Tube | Insulation Wall Thickness | | | |
|-------------|---------------------------|------|--------|------|
| | X ½" | X 1" | X 1 ½" | X2" |
| 5/8 | 2.0 | 3.0 | 3.5 | 4.5 |
| 7/8 | 2.0 | 3.0 | 4.0 | 5.0 |
| 1 – 1/8 | 2.5 | 3.0 | 4.0 | 5.0 |
| 1 – 3/8 | 2.5 | 3.5 | 4.5 | 5.5 |
| 1 -5/8 | 3.0 | 3.5 | 5.0 | 5.5 |
| 2 – 1/8 | 3.5 | 4.0 | 5.0 | 6.5 |
| 2 – 5/8 | 4.0 | 4.5 | 5.5 | 6.5 |
| 3 – 1/8 | 4.5 | 5.0 | 6.5 | 7.5 |
| 4 – 1/8 | 5.5 | 6.5 | 7.5 | 8.5 |
| 6 -1/8 | 7.5 | 8.5 | 9.5 | 11.0 |

Standard and MSS Compliant Seismic Shield - available sizes
Seismic Shield -Stocked Sizes

The physical and chemical properties of the products listed herein represent typical, average values obtained in accordance with accepted test methods and are subject to normal manufacturing variations. They are supplied as technical service and are subject to change without notice. Please contact customer service at (303) 715 -9990 to assure current information.

SEISMIC SHIELD ORDERING GUIDE

Sizing Guide To Select Seismic Shields (For Use *Without* High Density Inserts)

| Iron Pipe | Insulation Thickness | | | |
|-----------|----------------------|------|----------|------|
| | X 1/2" | X 1" | X 1-1/2" | X 2" |
| 1/2 | 2.0 | 3.0 | 4.0 | 5.0 |
| 3/4 | 2.5 | 3.0 | 4.0 | 5.0 |
| 1 | 2.5 | 3.5 | 4.5 | 5.5 |
| 1-1/4 | 3.0 | 3.5 | 5.0 | 5.5 |
| 1-1/2 | 3.0 | 4.0 | 5.0 | 6.5 |
| 2 | 3.5 | 4.5 | 5.5 | 6.5 |
| 2-1/2 | 4.0 | 5.0 | 6.5 | 7.5 |
| 3 | 4.5 | 5.5 | 6.5 | 7.5 |
| 4 | 5.5 | 6.5 | 7.5 | 8.5 |
| 5 | 6.5 | 7.5 | 8.5 | 9.5 |
| 6 | 7.5 | 8.5 | 9.5 | 11.0 |
| 8 | -- | 11.0 | 12.0 | 13.0 |
| 10 | -- | 13.0 | 14.0 | 15.0 |
| 12 | -- | 15.0 | 16.0 | 17.0 |
| 14 | -- | 16.0 | 17.0 | 18.0 |

| Copper Tube | Insulation Thickness | | | |
|-------------|----------------------|------|----------|------|
| | X 1/2" | X 1" | X 1-1/2" | X 2" |
| 5/8 | 2.0 | 3.0 | 3.5 | 4.5 |
| 7/8 | 2.0 | 3.0 | 4.0 | 5.0 |
| 1-1/8 | 2.5 | 3.0 | 4.0 | 5.0 |
| 1-3/8 | 2.5 | 3.5 | 4.5 | 5.5 |
| 1-5/8 | 3.0 | 3.5 | 5.0 | 5.5 |
| 2-1/8 | 3.5 | 4.0 | 5.0 | 6.5 |
| 2-5/8 | 4.0 | 4.5 | 5.5 | 6.5 |
| 3-1/8 | 4.5 | 5.0 | 6.5 | 7.5 |
| 4-1/8 | 5.5 | 6.5 | 7.5 | 8.5 |
| 6-1/8 | 7.5 | 8.5 | 9.5 | 11.0 |

To Order:

Determine Insulation Outside Diameter then select Standard or MSS Compliant Seismic Shields

PG Series Insulated Pipe Guides

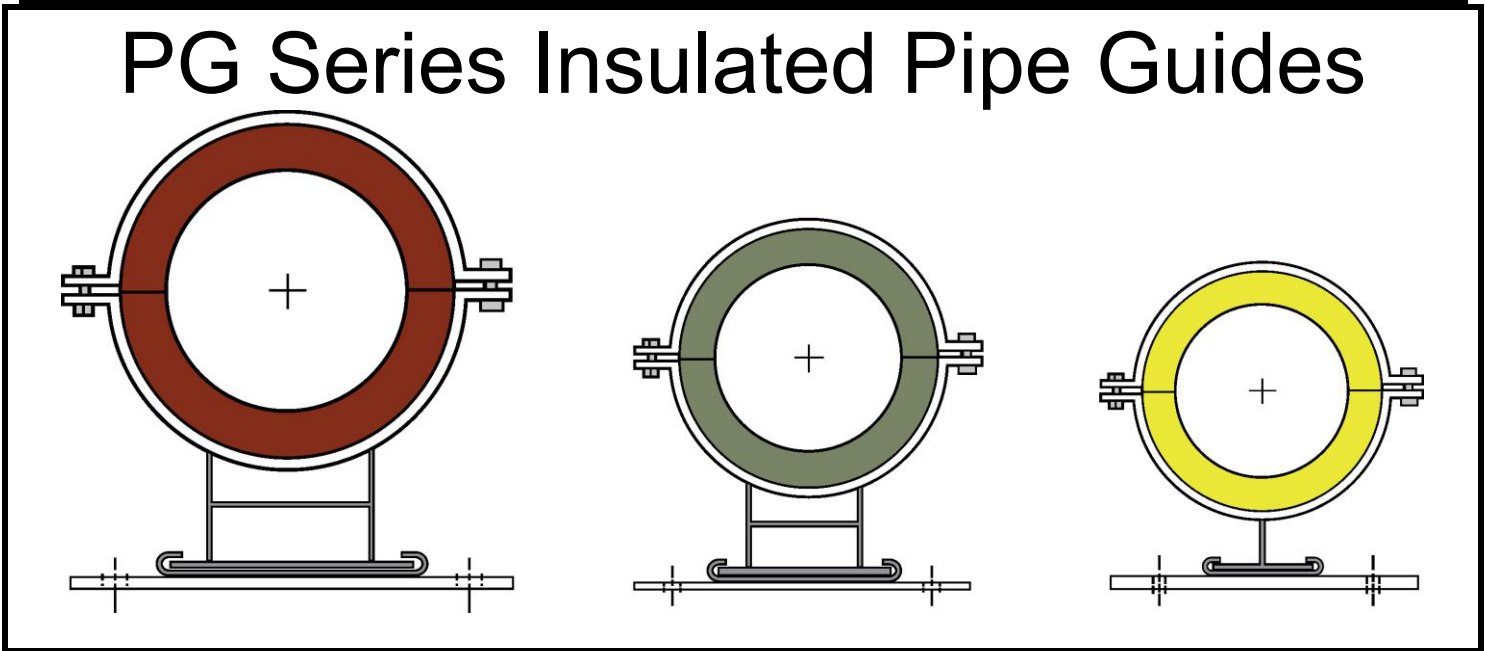

Description / Features

The Value Engineered Products line of insulated pipe guides is engineered to provide a superior method for pipe alignment and controlled travel. Insulation efficiency is achieved from the use of a unique and rugged Xonotlite insulation insert. This insert eliminates areas of heat loss or gain, impossible to control with direct attachment systems. The rugged nature and high compressive strength of this insert material allows the elimination of intermediary pipe supports resulting in fewer mechanical components to purchase and install. The 'PG' series of pipe guides incorporates a logical system of hardware design where pipe size and insulation thickness dictate the construction of the unit. PG Series insulated pipe guides are far superior to pipe rollers and may be seismic rated. The use of 'PS Series' pipe slides along with the 'PG Series' pipe guides assures that the critical 'bottom of pipe' (BOP) to 'top of steel' (TOS) dimension stays constant throughout the system.

PG-Plus Series insulated pipe guides allow additional axial travel. Units for severe loads and/or greater travel are available by design.

Applications

- All systems operating from + 20° to +1700° F.
- Pipe sizes 2" to 20" - custom sizes by design.
- Hanger spans to MSS SP-58, Table 4 maximums.
- Insulation thickness 1" to 4" (see application charts).
- Axial travel +/- 2" (PG Series) or +/- 4 1/2" (PG Plus Series)
- Lateral travel (all models) +/- 1/8".
- Eliminates pipe rollers and other direct attachment methods.

Materials / Construction

- Powder coated finish meeting ASTM B-117 (1000 hour salt spray) ASTM D-3359, ASTM D-3363.
- Heat bonded PTFE low friction slide pad.
- 1700 Degree F. temperature limit Xonotlite type 2 calcium silicate, meeting ASTM C-656 Type II Grade 5, E-84 Flame Spread -0-, Smoke Developed -0-.
- Factory applied jacketing meeting ASTM E 96A (maximum 0.02 perm), D-774, D-828 and E-84, Flame Spread -5-, Smoke Developed -5-.
- Insulation 'k'-Factor of .54 @ 200 degrees F.
- All units and components are asbestos free and 100% sourced and assembled in the U.S.A.

PS Series: Insulated Pipe Slides

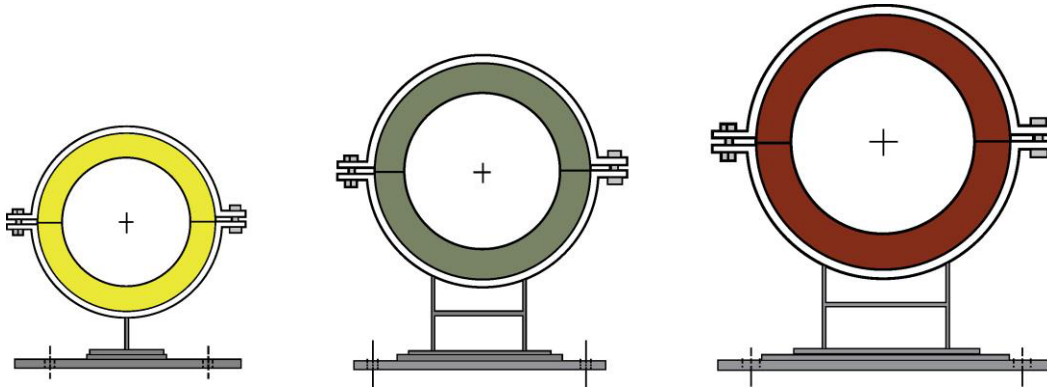

Description / Features

Value Engineered Products' line of insulated pipe slides provides a superior method of supporting pipes while allowing unrestricted axial and lateral pipe movement. Use of a 360° insulation insert of Xonotlite calcium silicate eliminates areas of heat loss or gain allowed by direct attachment systems. The rugged nature and high compressive strength of this insert material supports pipes to their maximum allowable spans, eliminating the need for intermediary supports. The 'PS Series' of insulated pipe slides incorporates a logical system of hardware design and when used in conjunction with the 'PG Series' of insulated pipe guides, the critical 'bottom of pipe (BOP) to 'top of steel' (TOS) dimension stays constant throughout the system. This practical design facilitates fast installation saving valuable field labor. The 'virgin' PTFE slide pad provides an extremely low coefficient of friction and is available in a variety of sizes which can allow up to seven inches of lateral travel.

Specify **PS-Plus Series** pipe slides for systems requiring greater axial and/or lateral pipe movement.

Applications

- All piping systems operating between +20° F. to +1700° F.
- Pipe sizes 1/2" to 20", larger pipe sizes by design.
- Hanger spans to MSS SP-58, Table 4 maximums.
- Insulation thickness 1" to 4" (see application charts).
- Axial travel +/- 2" (PG Series) or +/- 4 1/2" (PG Plus Series)
- Up to 7" of total lateral travel (PS-Plus Series).
- Base plates may be bolted or welded in place.

Material Construction

- Powder coated finish meeting ASTM B-117, ASTM D-3359, and ASTM D-3363.
- Heat bonded PTFE low friction slide pad.
- 1700° F. temperature limit Xonotlite calcium silicate, meeting ASTM C-656 Type II Grade 5, E-84, Flame Spread -0-, Smoke Developed -0-.
- Factory applied jacketing meeting ASTM E 96A (maximum 0.02 perm) ASTM D-774, D-828 and E-84, Flame Spread -5- Smoke Developed -5-.
- Insulation 'k'-Factor of .54 @ 200 degrees F.
- 100% American-made materials and construction.

PA Series: Insulated Pipe Anchors

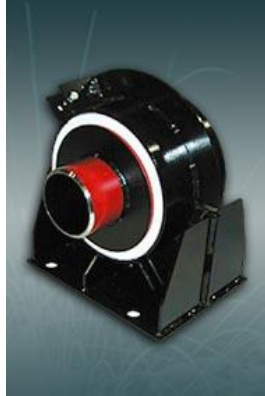

Value Engineered Products recognizes the need to provide insulated pipe anchors to complete their line of insulated pipe hangers, slides and guides.

Many competitors promote anchors in their catalogues and provide tables which state allowable vertical and axial loads. These two ratings, however, only apply to a system where the anchor would be 'bracketed' by expansion joints, - i.e. expansion joint - anchor - expansion joint.

In all other 'real world' applications, there are **at least six forces** at play whose **combined** stresses must be taken into account. The net, cumulative effect of these combined forces typically far exceeds published 'allowable loads' for insulated anchors. Additional 'moments of force' caused by a variety of system operating factors can easily exceed the highest published load ratings. The type of expansion joints, loops, or bellows used in a system also vary widely in design and load characteristics.

Some mechanical specifications call for 'friction anchors'. This type of anchor should truly be called a '*fiction* anchor' as there is no possible way to calculate the ability of this type of unit to operate as an anchor. Each anchor will have a different amount of resistance to movement based on how well the section of insulation matches the pipe and the amount of force applied to the pipe by the clamp. The smallest amount of variation or wear to the insulation insert or deviation in clamping force will change the anticipated (or required) resistance to pipe movement.

For these reasons, Value Engineered Products requires specific temperature ranges, pipe spans, and system applications before making an anchor recommendation. Our 'Light Duty' PA (Pre-Insulated Anchor) is appropriate where 'friction anchors' are called for. Our Heavy Duty PA is an engineered unit and can only be quoted once the required system parameters are provided.

In all cases VEP Pre-Insulated Pipe Anchors require field welding to the pipe. For this reason, true pipe anchors for copper tube cannot be provided.

DATA

Insulation Inserts:

- Xonotlite type 2 calcium silicate, meeting ASTM C-656 Type II Grade 6, E-84, Flame Spread -0-, Smoke Developed -0-
- Compressive strength - 900 PSI or 1600 PSI (depending on system design).
- Temperature limit to 1800° F.
- Flexural strength - 550 PSI or 800 PSI (depending on system design).
- Meets ASTM C-656 Type II, Minimum Grade 6 E-84, Flame Spread -0-, Smoke Developed -0-.

Anchor Hardware:

- Steel meeting ASTM A-36.
- Powder coated per ASTM B-117 (1000 hour salt spray), ASTM D-3363 (pencil hardness 'H'), and ASTM D-3359 (adhesion '5B').
- Fasteners are plated - Grade 2, Industrial.

INSULATED GUIDE AND SLIDE SELECTION CHART

- ◆ Shaded Areas Indicate Recommended Applications.
- ◆ 'Bottom of Pipe' to 'Top of Steel' (BOP-TOS).
- ◆ PG and PS Units Allow +/- 2" of Axial Travel.
- ◆ PG Units Limit Lateral Travel to 1/8".
- ◆ Specify 'PLUS' for +/- 4-1/2" of Axial Travel.

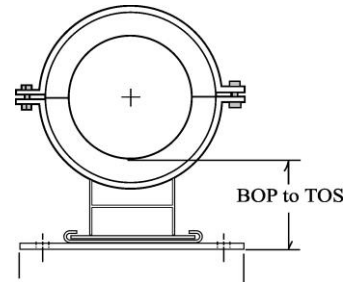

PG-1 and PS-1 BOP to TOS

| Insulation Thickness | PIPE SIZE | | | | | | | |
|--|------------|------------|------------|------------|------------|------------|------------|------------|
| | 1/2 | 3/4 | 1 | 1-1/4 | 1-1/2 | 2 | 2-1/2 | 3 |
| 1" | 4" | 4" | 4" | 4" | 4" | 4" | 4" | 4" |
| 1-1/2" | 4" | 4" | 4" | 4" | 4" | 4" | | |
| 2" | 4" | 4" | 4" | 4" | | | | |
| 2-1/2" | | | | | | | | |
| 3" | | | | | | | | |
| 3-1/2" | | | | | | | | |
| 4" | | | | | | | | |
| ALLOWABLE LOAD (Vertical & Lateral) | 115 | 145 | 185 | 235 | 265 | 355 | 405 | 495 |

PG-2 and PS-2 BOP to TOS

| Insulation Thickness | PIPE SIZE | | | | | | |
|--|------------|------------|------------|-------------|-------------|-------------|-------------|
| | 2 | 2-1/2 | 3 | 4 | 5 | 6 | 8 |
| 1" | | | | 4" | 4" | 4" | 4" |
| 1-1/2" | | 4" | 4" | 4" | 4" | 4" | 4" |
| 2" | 4" | 4" | 4" | 4" | 4" | 4" | |
| 2-1/2" | 4" | 4" | 4" | 4" | 4" | 4" | |
| 3" | 6" | 6" | 6" | 6" | 6" | | |
| 3-1/2" | 6" | 6" | 6" | 6" | | | |
| 4" | 6" | 6" | 6" | | | | |
| ALLOWABLE LOAD (Vertical & Lateral) | 670 | 810 | 990 | 1270 | 1570 | 1870 | 2430 |

PG-3 and PS-3 BOP to TOS

| Insulation Thickness | PIPE SIZE | | | | | | | |
|--|-------------|-------------|-------------|-------------|-------------|-------------|-------------|-------------|
| | 4 | 5 | 6 | 8 | 10 | 12 | 14 | 16 |
| 1" | | | | | 4" | 4" | 4" | 4" |
| 1-1/2" | | | | | 4" | 4" | 4" | 4" |
| 2" | | | | 4" | 4" | 4" | 4" | 4" |
| 2-1/2" | | | | 6" | 6" | 6" | 6" | |
| 3" | | | 6" | 6" | 6" | 6" | 6" | |
| 3-1/2" | | 6" | 6" | 6" | 6" | 6" | | |
| 4" | 6" | 6" | 6" | 6" | 6" | | | |
| ALLOWABLE LOAD (Vertical & Lateral) | 1690 | 2100 | 2500 | 3250 | 4050 | 4800 | 5300 | 6100 |

Weather Shield Upgrade Protection System For Outdoor Applications



Description / Features

WeatherShield modifications are appropriate for hostile environment or outdoor applications. For calcium silicate products we utilize Johns Manville T-1200 water resistant calcium silicate formulated specifically to shed water. The Standard WeatherShield is constructed with the Ventureclad Smooth aluminum jacketing material laminated between the steel protection shield and the insulation material. WeatherShield modifications may be specified for Pro-Shield, MaxSpan or MaxSpan R.H. designs. WeatherShields *must be installed as 360° units* to maintain their integrity and weather resistance.

Construction / Installation Procedure

On large units, the bottom shield's weather barrier covers approximately 240° of the unit's circumference. The flaps overlap the top vapor barrier and are then attached with two strips of self-sealing tape, sealing it to the lower half of the unit. If a top metal shield is required, it can be slid into place completing the unit. Insulation and jacketing extend beyond the steel protection shield for a neat, weather-tight connection with the adjoining insulation.

Standard weather barrier layer is smooth surface Ventureclad aluminum jacketing.

Pricing Policy

All Weather Shield upgrades will be quoted on a per job basis to a list of materials.

Duct Trapeze Corner Supports

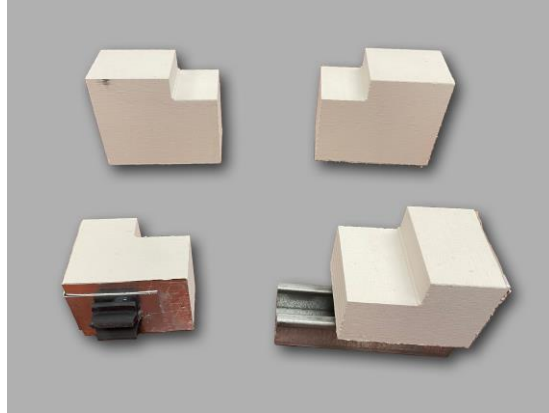

Description / Features

Duct trapeze corner supports are high compressive strength (450 PSI) insulation segments with vapor barrier and protective shield. They are designed to be installed on trapeze mounts prior to duct installation. Duct is then set on the units so clearance for insulation is assured. 90° design fits snug to the duct, preventing misalignment.

Construction / Installation Procedure

Units have 90° design to fit and guide corners of duct. They have a vapor barrier and steel shield with an integral section of rubber strut seal. Lock the unit into the strut top on one side of the trapeze and measure from inside the notch to provide correct spacing and lock in a second unit to complete the support.

Standard unit sizes accommodate 2" thick or 3" thick duct insulation. Custom thickness units are available.

Pricing Policy

Duct trapeze corner supports will be quoted on a per job basis to a list of materials.

Pipe Dimensions/MSS Allowable Spans Application Information

Pro-Shield/ Quik-Shield

Spans Are Based On MSS SP-58 Table A3, Type 40 Shields

| Nominal Pipe Size | Span | | Anticipated Load* (Pounds) | Maximum Allowable Loads | | |
|----------------------|------|--------|-------------------------------|-------------------------|---------|--------|
| | Feet | Meters | | Clevis | Trapeze | Roller |
| 2 | 10 | 3.0 | 51 | 160 | 80 | 70 |
| 4 | 10 | 3.0 | 163 | 380 | 170 | 165 |
| 6 | 10 | 3.0 | 315 | 605 | 330 | N/R |
| 8 | 10 | 3.0 | 502 | 800 | 510 | N/R |
| 10 | 10 | 3.0 | 747 | 1160 | 830 | N/R |
| 12 | 10 | 3.0 | 1021 | 1400 | 1200 | N/R |
| 14 | 10 | 3.0 | 1222 | 1800 | 1250 | N/R |
| 16 | 10 | 3.0 | 1595 | 2600 | N/R | N/R |
| 18 | 10 | 3.0 | 2018 | 3300 | N/R | N/R |
| 20 | 10 | 3.0 | 2438 | 4000 | N/R | N/R |

Allowable Loads and Hanger Spans for Calcium Silicate Based Supports

Maximum allowable loads include a minimum 3.5:1 safety factor.

Spans may be increased *only* when installed in band-type hangers.

MaxSpan / MaxSpan R.H.

Spans Are Based On MSS SP-58 Table 4, Water Service

| Nominal Pipe Size | Span | | Anticipated Load* (Pounds) | Maximum Allowable Loads | | |
|----------------------|------|--------|-------------------------------|-------------------------|--------------|--------|
| | Feet | Meters | | Clevis | Flat Surface | Roller |
| 4 | 14 | 4.3 | 228 | 405 | 405 | 405 |
| 6 | 17 | 5.2 | 535 | 1015 | 1070 | 1015 |
| 8 | 19 | 5.8 | 955 | 1555 | 1625 | 1555 |
| 10 | 22 | 6.1 | 1644 | 2450 | 2575 | 2450 |
| 12 | 23 | 7.2 | 2349 | 3480 | 3550 | 3480 |
| 14 | 25 | 7.6 | 3050 | 4770 | 4820 | 4770 |
| 16 | 27 | 8.3 | 4307 | 8050 | 8250 | 8050 |
| 18 | 28 | 8.5 | 5651 | 9025 | 9505 | 9025 |
| 20 | 30 | 9.1 | 7315 | 9550 | 10550 | 9550 |

'MaxSpan' units may be used to MSS Table 3 maximum hanger spans *only* when installed in band- or clamping-type (i.e. 'two-bolt') hangers. **All flat surface and roller ratings are for MaxSpan R.H. units.**

*Anticipated load is the weight (in pounds) of a water filled Schedule 40 pipe for the indicated span. When using the 'Maximum Allowable Loads' to determine hanger spacing, the actual load must include pipe weight, weight of transported media, valves or fittings or other items which may affect the total weight of that span of pipe.

N/R = Not Recommended

Hanger Sizing Guide

Minimum Hanger Inside Hanger Diameters (In Inches) To Fit Standard Insulated Pipe Supports

| IPS | INSULATION THICKNESS | | | | | |
|-----------|----------------------|--------|--------|--------|--------|--------|
| PIPE SIZE | 1/2" | 1" | 1 1/2" | 2" | 2 1/2" | 3" |
| 1/2 | 2.000 | 3.000 | 4.125 | 5.125 | 6.750 | 7.750 |
| 3/4 | 2.250 | 3.000 | 4.125 | 5.125 | 6.750 | 7.750 |
| 1 | 2.500 | 3.625 | 4.625 | 5.692 | 6.750 | 7.750 |
| 1 1/4 | 3.000 | 3.625 | 5.125 | 5.692 | 6.750 | 7.750 |
| 1 1/2 | 3.155 | 4.125 | 5.125 | 6.750 | 7.750 | 8.750 |
| 2 | 3.625 | 4.625 | 5.625 | 6.750 | 7.750 | 8.750 |
| 2 1/2 | 4.125 | 5.125 | 6.750 | 7.750 | 8.750 | 9.750 |
| 3 | 4.625 | 5.625 | 6.750 | 7.750 | 8.750 | 9.750 |
| 4 | 5.625 | 6.750 | 7.750 | 8.750 | 9.750 | 10.875 |
| 5 | 6.750 | 7.750 | 8.750 | 9.750 | 10.875 | 11.875 |
| 6 | 7.750 | 8.750 | 9.750 | 10.875 | 11.875 | 12.875 |
| 8 | 9.875 | 10.875 | 11.875 | 12.875 | 14.250 | 15.250 |
| 10 | 12.000 | 12.875 | 14.250 | 15.250 | 16.375 | 17.375 |
| 12 | 14.000 | 15.250 | 16.250 | 17.250 | 18.375 | 19.375 |
| 14 | 15.125 | 16.375 | 17.375 | 18.375 | 19.375 | 20.250 |
| | | | | | | |
| | | | | | | |
| | | | | | | |
| COPPER | INSULATION THICKNESS | | | | | |
| TUBE SIZE | 1/2" | 1" | 1 1/2" | 2" | 2 1/2" | 3" |
| 5/8 | 2.000 | 3.00 | 3.50 | 4.63 | 5.63 | 6.75 |
| 7/8 | 2.000 | 3.00 | 4.125 | 5.125 | 6.75 | 7.75 |
| 1 1/8 | 2.250 | 3.00 | 4.125 | 5.125 | 6.75 | 7.75 |
| 1 3/8 | 2.500 | 3.625 | 4.625 | 5.692 | 6.75 | 7.75 |
| 1 5/8 | 3.000 | 3.625 | 5.125 | 5.692 | 6.75 | 7.75 |
| 2 1/8 | 3.625 | 4.125 | 5.125 | 6.75 | 7.75 | 8.75 |
| 2 5/8 | 4.125 | 4.625 | 5.625 | 6.75 | 7.75 | 8.75 |
| 3 1/8 | 4.625 | 5.125 | 6.75 | 7.75 | 8.75 | 9.75 |
| 4 1/8 | 5.625 | 6.75 | 7.75 | 8.75 | 9.75 | 10.875 |
| 5 1/8 | 6.750 | 7.75 | 8.75 | 9.75 | 10.875 | 11.875 |
| 6 1/8 | 7.750 | 8.75 | 9.75 | 10.875 | 11.875 | 12.875 |

NOTE: Hanger inside diameters must be large enough to accommodate the insulation wall thickness and the steel protection shield thickness.

Units comply with ASTM C-585 dimensional standards, subject to normal manufacturing tolerances.

Manufacturers Standardization Society (MSS) Recommended Spans Schedule 40 Steel Pipe

| Nominal Pipe Size | Actual O.D. | Weight Per Ft. Empty (lb.) | Weight Per Ft. Fully Flooded | Spans Per MSS SP-58 Table 4 | Spans Per MSS SP-58 Table A3 |
|-------------------|-------------|----------------------------|------------------------------|-----------------------------|------------------------------|
| 1/2 | .840 | .85 | .98 | 7 | 7 |
| 3/4 | 1.050 | 1.13 | 1.36 | 7 | 7 |
| 1 | 1.315 | 1.68 | 2.05 | 7 | 7 |
| 1-1/4 | 1.660 | 2.27 | 2.92 | 7 | 7 |
| 1-1/2 | 1.900 | 2.72 | 3.60 | 9 | 9 |
| 2 | 2.650 | 3.65 | 5.11 | 10 | 10 |
| 2-1/2 | 2.875 | 5.79 | 7.87 | 11 | 10 |
| 3 | 3.500 | 7.58 | 10.8 | 12 | 10 |
| 4 | 4.500 | 10.8 | 16.3 | 14 | 10 |
| 5 | 5.563 | 14.6 | 22.3 | 16 | 10 |
| 6 | 6.625 | 18.9 | 31.5 | 17 | 10 |
| 8 | 8.625 | 28.6 | 50.3 | 19 | 10 |
| 10 | 10.75 | 40.5 | 74.7 | 22 | 10 |
| 12 | 12.75 | 53.5 | 102.2 | 23 | 10 |
| 14 | 14.00 | 63.4 | 122.2 | 25 | 10 |
| 16 | 16.00 | 82.8 | 159.5 | 27 | 10 |
| 18 | 18.00 | 104.7 | 201.8 | 28 | 10 |
| 20 | 20.00 | 123.1 | 243.9 | 30 | 10 |
| 24 | 24.00 | 171.3 | 345.9 | 32 | 10 |

Copper Tube (Type-K)

| Nominal Tube Size | Actual O.D. | Weight Per Ft. Empty (lb.) | Weight Per Ft. Fully Flooded | Spans Per MSS SP-58 Table 4 | Spans Per MSS SP-58 Table A3 |
|-------------------|-------------|----------------------------|------------------------------|-----------------------------|------------------------------|
| 1/2 | .625 | .34 | .44 | 5 | 5 |
| 3/4 | .875 | .64 | .87 | 5 | 5 |
| 1 | 1.125 | .84 | 1.22 | 6 | 6 |
| 1-1/4 | 1.375 | 1.04 | 1.61 | 7 | 7 |
| 1-1/2 | 1.625 | 1.36 | 2.16 | 8 | 8 |
| 2 | 2.125 | 2.06 | 3.44 | 8 | 8 |
| 2-1/2 | 2.625 | 2.93 | 5.06 | 9 | 9 |
| 3 | 3.125 | 4.00 | 7.03 | 10 | 10 |
| 4 | 4.125 | 6.51 | 11.8 | 12 | 10 |

All MSS references and quotes in this catalogue are extracted from ANSI / MSS SP-58 (2009) with permission of the publisher, The Manufacturers Standardization Society.

Suggested Specification Guidelines for Insulated Pipe Supports

Division 22

(Previous specifications, Division 15):

Section: Hangers and Supports

- 1) Thermal hanger shields shall be used on all horizontal insulated pipe systems at each point of support. Manufactured units shall comply with MSS SP-58 standards and be tested per MSS guidelines. Each assembly shall fit the various pipe diameters and match the outside diameter of the adjoining pipe insulation.
- 2) Thermal hanger inserts shall be calcium silicate with a minimum compressive strength of 100 PSI. The insert shall be jacketed with industry standard, non-reactive, all service jacket meeting ASTM E 96A (maximum 0.02 perm). 'Water-resistant coatings', which do not provide a sealable vapor barrier, shall not be allowed. A mastic of a contrasting color may be used (i.e. Childers CP-30 or MEI 55-10 or equal), providing the longitudinal seam is field-sealed during installation.
- 3) A rolled shield of G-90 galvanized steel shall be an integral part of the unit and shall be of a gauge and length appropriate for the compressive strength of the insert material and type of hanger.
- 4) Insulation and jacket shall extend a minimum of one inch (1") beyond each end of the galvanized steel shield to provide a complete, neat and vapor-tight seal with the adjoining insulation.
- 5) Hanger type and span between hangers shall govern the type of thermal hanger shield used and shall be as follows:
 - Band-type hangers to 10 foot maximums** (clevis, teardrop) – Value Engineered Products' (VEP) Pro-Shield, Quik-Shield or equal
 - Roller-type hangers, regardless of hanger spans** - VEP's MaxSpan R.H. or equal.
 - Band-type hangers with spans greater than 10 feet**- VEP's MaxSpan units or equal.
 - Trapeze style and other clamping-type supports to 10-foot maximums** – VEP's Pro-Shield or equal.
 - Trapeze style and other clamping-type supports exceeding 10 feet** - VEP's MaxSpan units or equal.
- 6) Product must be tested to ASTM E84
- 7) Safety Ratio shall be a minimum of 3.5:1 - (support capabilities to anticipated pipe load).
- 8) Independent test results documenting the compliance of 'or equal' products shall be available upon request of the Architect, Engineer or Owner.

Manufacturers Standardization Society (MSS) Statement

Since 2009, the MSS SP-58 incorporates and supersedes ANSI/MSS SP-69-2003, MSS SP-77-1995 (R 2000), MSS SP-89-2003, and MSS SP-90-2000. Engineering specifications may still reference the out-of-date material and cause confusion concerning the length requirements for Thermal Hanger Shield Inserts. The Information in paragraph 7.2 through 7.66 of the current MSS SP-58 is gathered from two source documents as follows:

MSS SP-58 and SP-69 were widely referenced throughout the industry for insulation protection shields. Both the SP-58 and SP-69 documents referenced Type 40 shields. Each document had its own 'Table 5' (often referenced in individual specifications). Table 3 from SP-69 might also be included in any given specification and warranted consideration. For specifications referencing these superseded documents, it is essential that the user be aware of the scope of each publication and its purpose.

MSS SP-69 - Table 3 - Specified the maximum pipe span allowed when hangers are directly attached to the pipe.

MSS SP-69 - Table 5 - Specified maximum allowable pipe spans as well as protection shield lengths and gauges for insulated systems installed **without** the use of manufactured thermal hanger shields.

MSS SP-58 - Table 5 and Paragraph 9.2 provided information for insulated pipe systems utilizing protection shields either **with** or **without** high-density inserts.

IN GENERAL, THE MSS SP-69 ACTED AS A GUIDE FOR INSTALLING THE COMPONENTS OF A MECHANICAL SYSTEM. IT DIRECTED THE READER (PARAGRAPH 5.1 PIPE HANGERS AND SUPPORTS - SELECTION AND APPLICATION) TO REFER TO THE MSS SP-58 FOR INFORMATION RELATED TO PIPE SUPPORTS:

"The materials of all pipe hanging and supporting elements shall be in accordance with the MSS SP-58."

The MSS SP-58 was a reference for 'material, design and manufacture' of the individual components of the mechanical system. SP-58 paragraph 9.2 specifically addressed the use of Type 40 shields both *with* and *without* the use of high-density insulation materials. Paragraph 9.2.2 superseded the shield lengths and gauges shown in *this* document's Table 5:

"When pipe covering protection shields are used with high compressive strength inserts, the shield length and thickness shall be appropriate for the compressive strength of the insert material. The insert shall be at least as long as the shield and where a vapor barrier is required, the vapor barrier shall extend two inches beyond the shield and overlap the outside circumference by two inches."

All Value Engineered Products units are made with high-density insulation with compressive strengths from 24 PSI up to 3000 PSI. Additionally, every model includes the vapor barrier required to meet MSS-based specifications. Therefore, all 360° Value Engineered Products exceed the requirements of a Type 40 shield. The VEP Quik-Shield provides the basic components necessary for field fabrication of a Type 40 shield and may meet MSS-based specifications.

TERMS AND CONDITIONS OF SALE, WARRANTY

Value Engineered Products guarantees that its products are free from manufacturing defects or damage when released from our warehouse. Value Engineered Products further warrants our workmanship and guarantees compliance with published ASTM dimensional standards. Should a claim for defective materials arise, it must be brought to our attention, in writing, within 30 days after purchase. Upon inspection by Value Engineered Products, new product shall be furnished for replacement of defective units. Value Engineered Products shall not be liable for incorrect selection or improper installation of our products. All dimensions, ratings and designs have been carefully determined; however, they are not guaranteed.

Claims for shortages in shipments must be made within 10 days from shipment. Deductions on invoice amounts are not allowed without prior written approval.

Permission to return standard stocked merchandise must be obtained in writing. Credit will be issued subject to the following:

1. Return freight charges must be prepaid.
2. Proportional outbound freight will be deducted on freight prepaid orders.
3. All material must be in original condition and in full box quantities on arrival at our warehouse.
4. A 35% restocking fee will be applied.
5. Special orders and noted sizes or project specific designs are not returnable. Special orders are defined as any product not complying with our standard published data sheet and listed on our price pages.
6. Must be within 90 days of sales confirmation order

Value Engineered Products reserves the right to refuse credit on any returns. *Credits for returned goods shall be applied to future sales.*

Value Engineered Products has designed a line of thermal hanger shields requiring a minimum of models and styles in order to make ordering and installation easy. It is the responsibility of the customer to order correct sizes and quantities, to know whether the pipe is steel, cast iron, ductile iron, stainless steel tube or copper and to determine the correct insulation thickness. Request for returns of incorrectly ordered material may be refused.

**Updated information is always available on our website
www.valueng.com**

NOTES

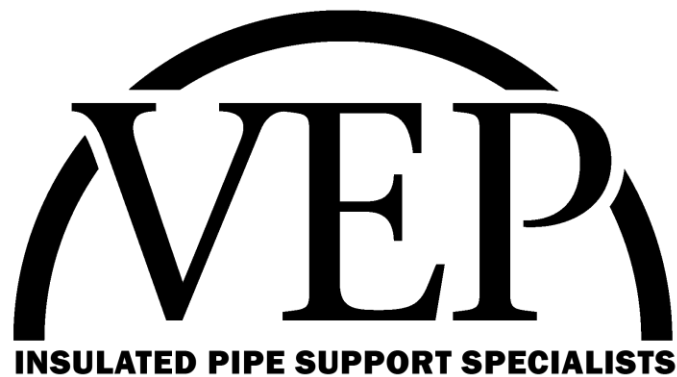

756 S. Jason Street, Suite 17 • Denver, Colorado 80223
Phone (303) 715-9990 • sales@valueng.com
www.valueng.com

PROUDLY SOURCED AND MANUFACTURED IN THE U.S.A.